

[54] AGRICULTURAL IMPLEMENT

[75] Inventor: William M. Johnson, Winchlesea, Australia

[73] Assignee: Ralph McKay Limited, Maidstone, Australia

[**] Term: 14 Years

[21] Appl. No.: 686,699

[22] Filed: Dec. 27, 1984

[30] Foreign Application Priority Data

Jun. 29, 1984 [AU] Australia 8006/84

[52] U.S. Cl. D15/29; D15/11

[58] Field of Search D15/10, 11, 29, 32; 111/86; 172/382, 699, 700, 721, 724, 733

[56] References Cited

U.S. PATENT DOCUMENTS

D. 237,644	11/1975	Williams	D15/29
D. 277,862	3/1985	Johnson et al.	D15/29
2,779,263	1/1957	Franz et al.	172/724
3,517,752	6/1970	Glee	111/86
4,336,844	6/1982	Helbig et al.	172/700
4,446,801	5/1984	Machnee et al.	111/86

Primary Examiner—B. J. Bullock

Assistant Examiner—Suzanne N. Gitlin
Attorney, Agent, or Firm—Christel, Bean & Linihan

[57] CLAIM

The ornamental design for agricultural implement, as shown and described.

DESCRIPTION

FIG. 1 is a top plan view of an agricultural implement showing my new design;

FIG. 2 is a front elevational view thereof;

FIG. 3 is a rear elevational view thereof;

FIG. 4 is a side elevational view taken from the right of FIG. 2;

FIG. 5 is a perspective view thereof;

FIG. 6 is a top plan view of a second embodiment of FIG. 1;

FIG. 7 is a front elevational view of FIG. 6;

FIG. 8 is a rear elevational view of FIG. 6;

FIG. 9 is a side elevational view taken from the right of FIG. 7;

FIG. 10 is a perspective view of FIG. 6;

FIG. 11 is a top plan view of a third embodiment of FIG. 1;

FIG. 12 is a front elevational view of FIG. 11;

FIG. 13 is a rear elevational view of FIG. 11;

FIG. 14 is a side elevational view of FIG. 12;

FIG. 15 is a perspective view of FIG. 11.

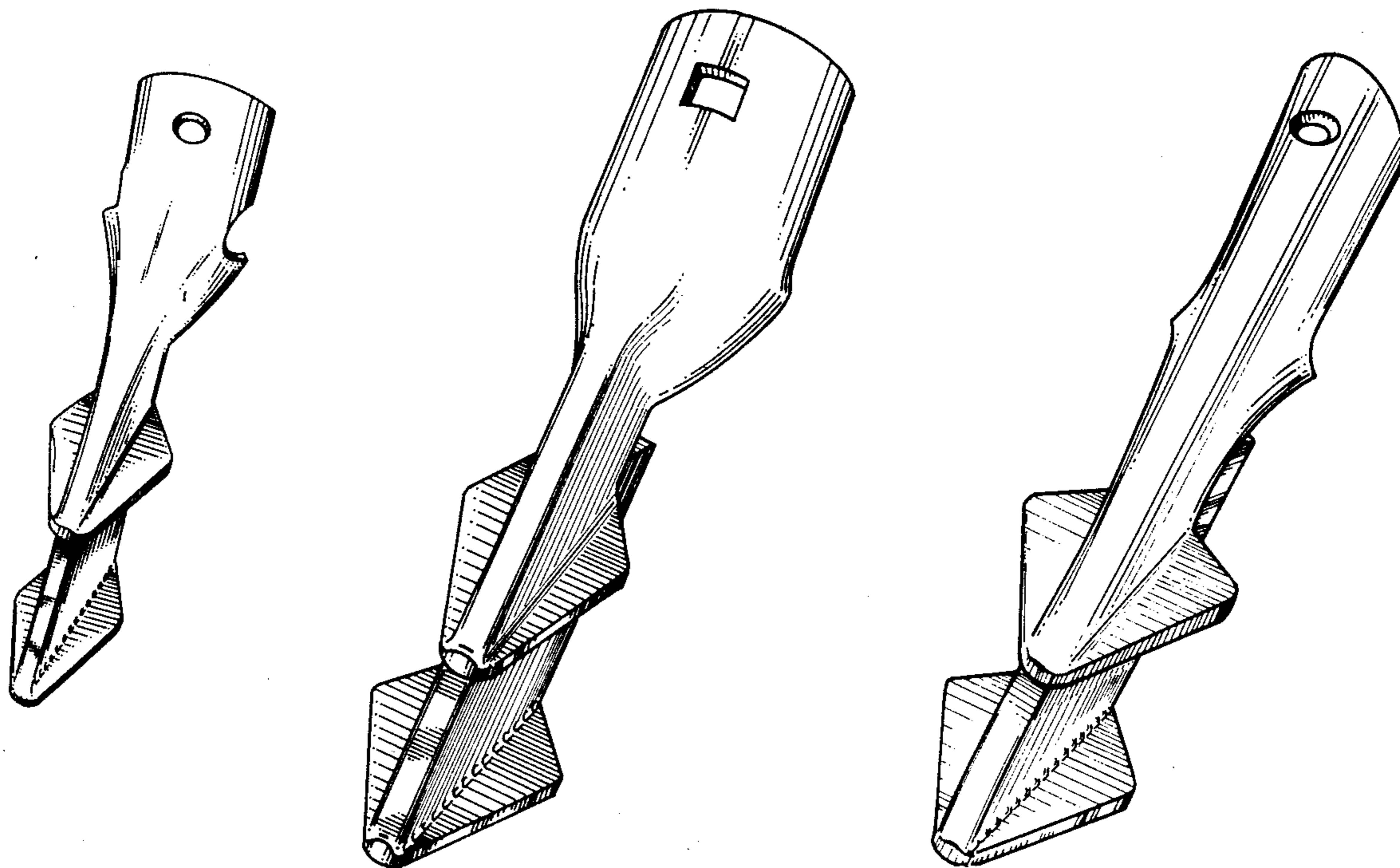

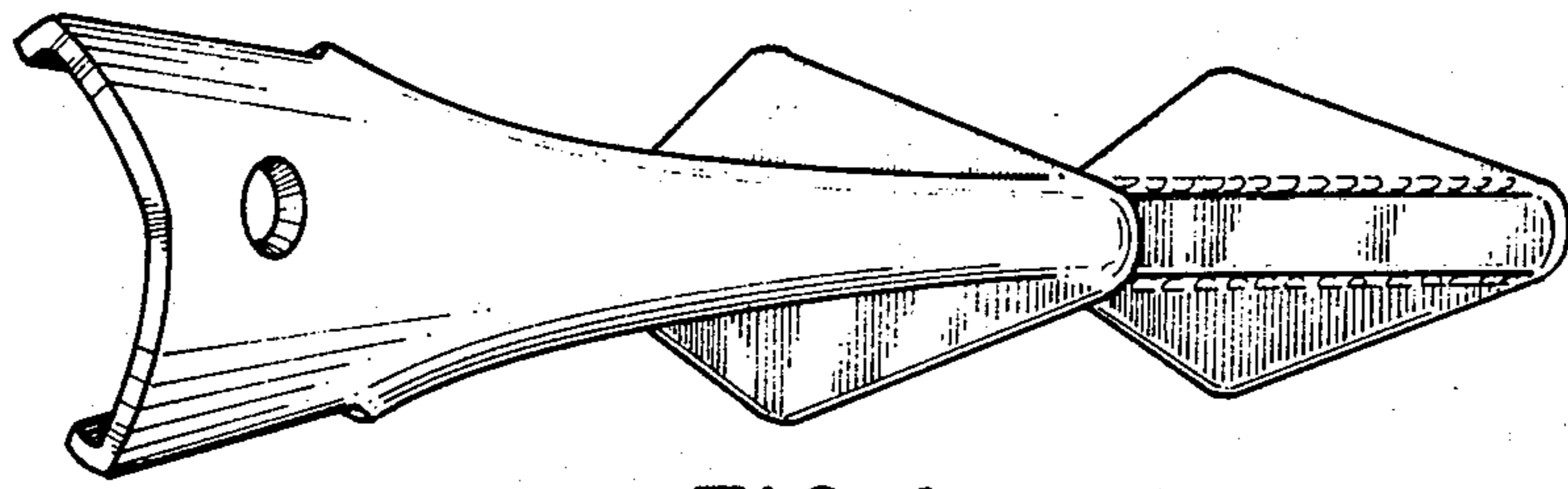

FIG. 1

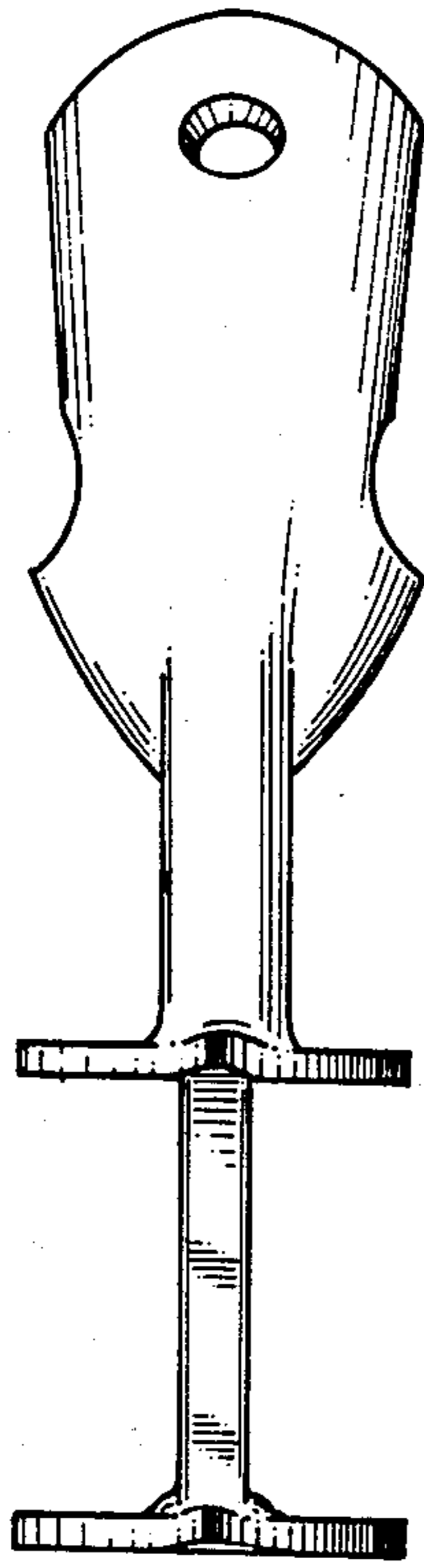

FIG. 2

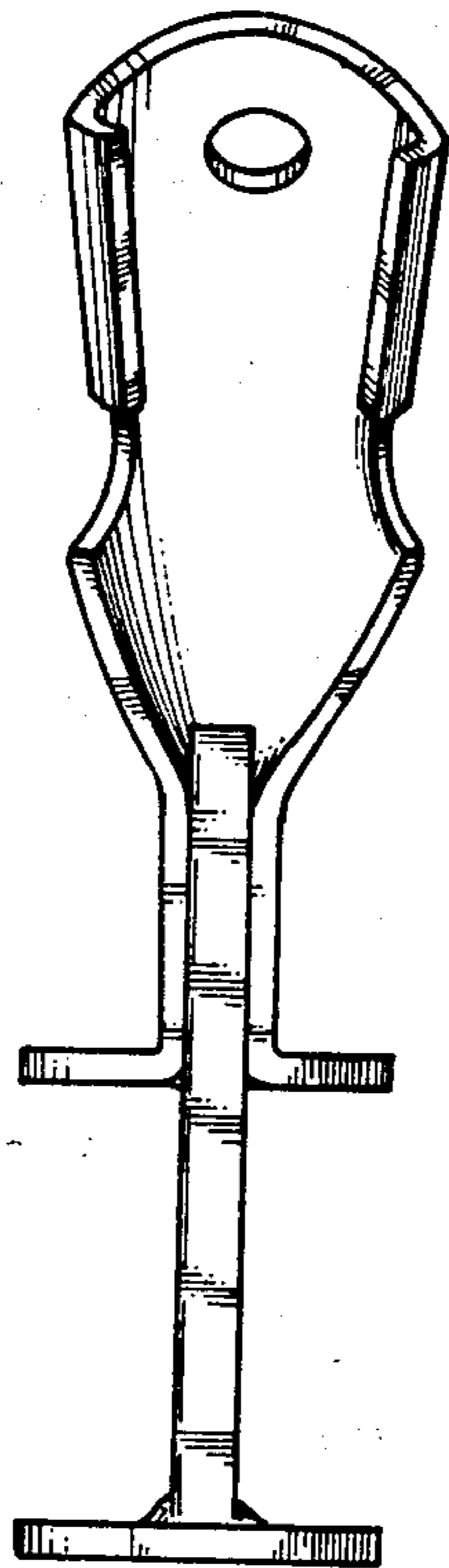

FIG. 3

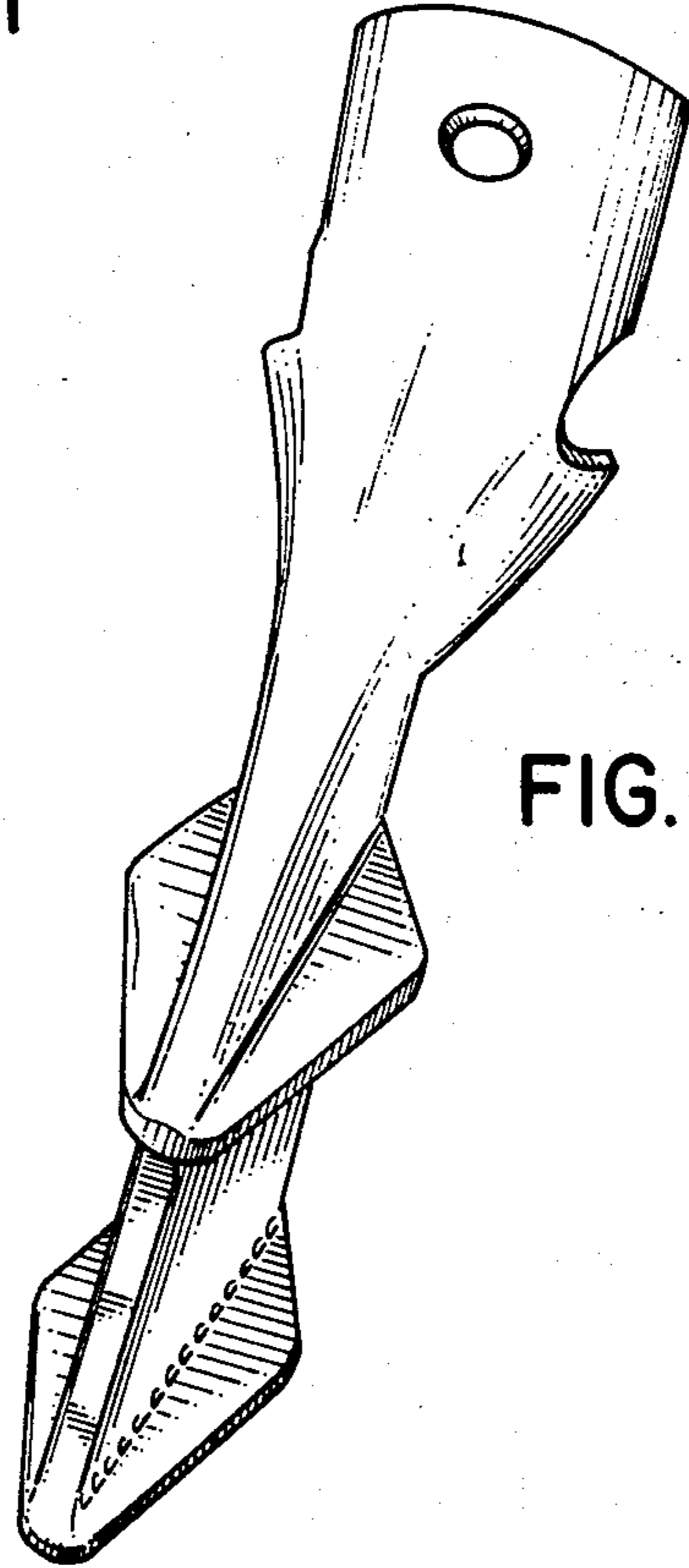

FIG. 5

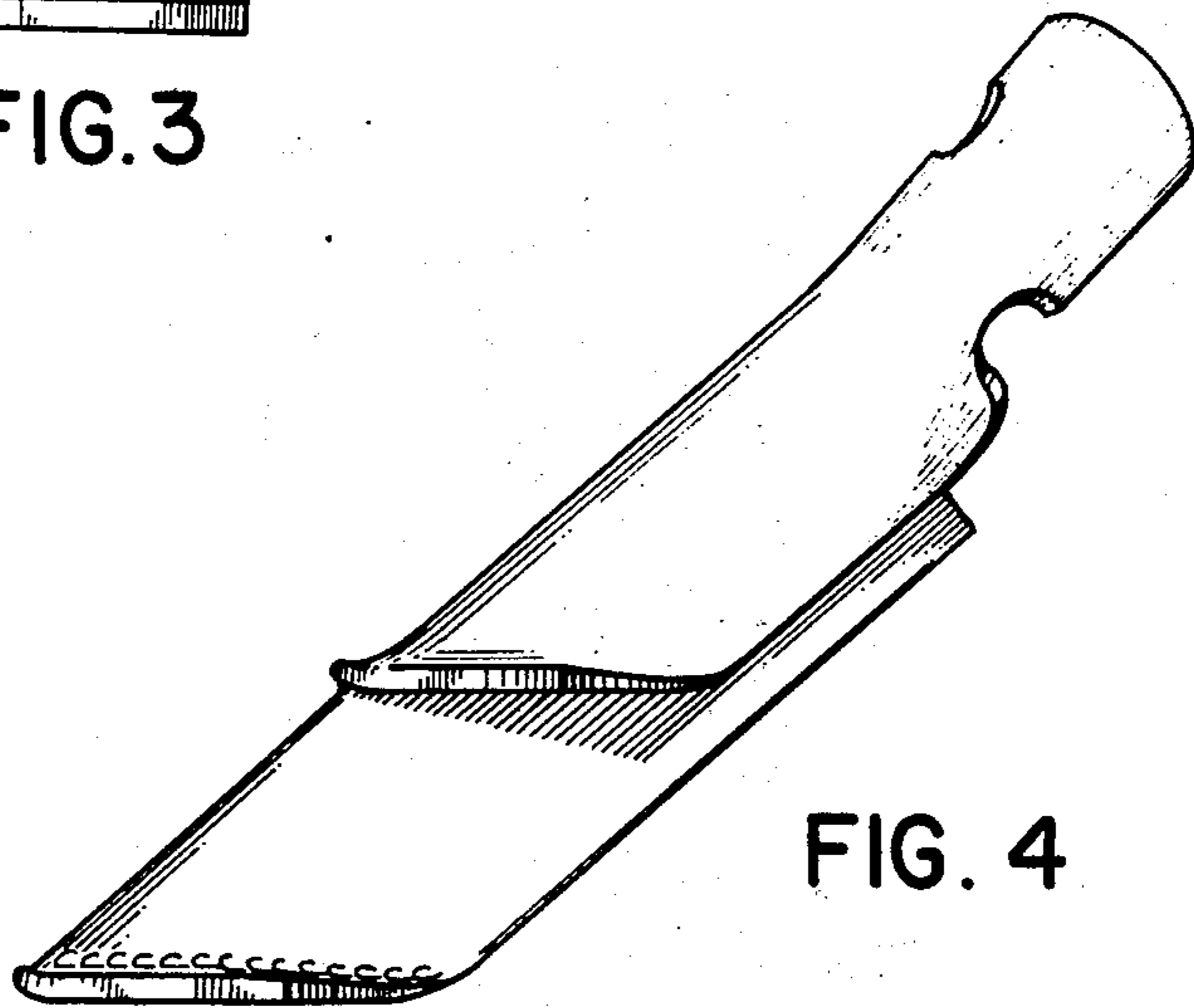

FIG. 4

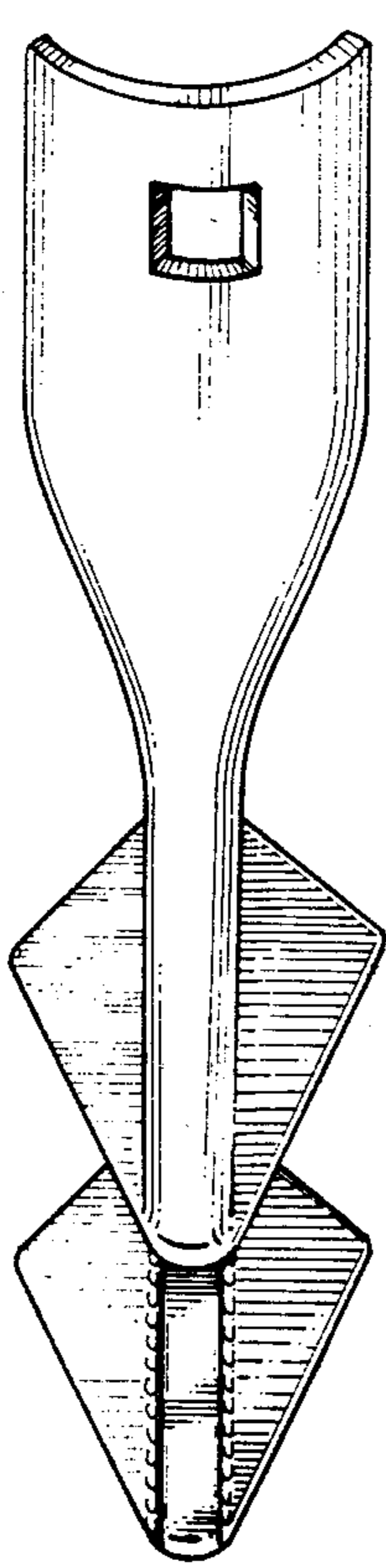

FIG. 6

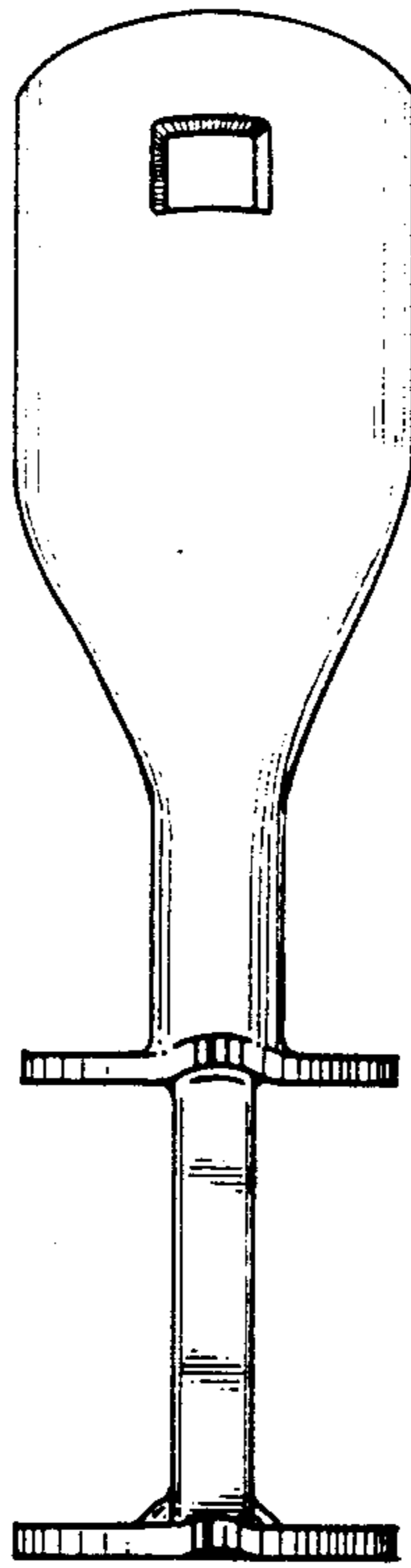

FIG. 7

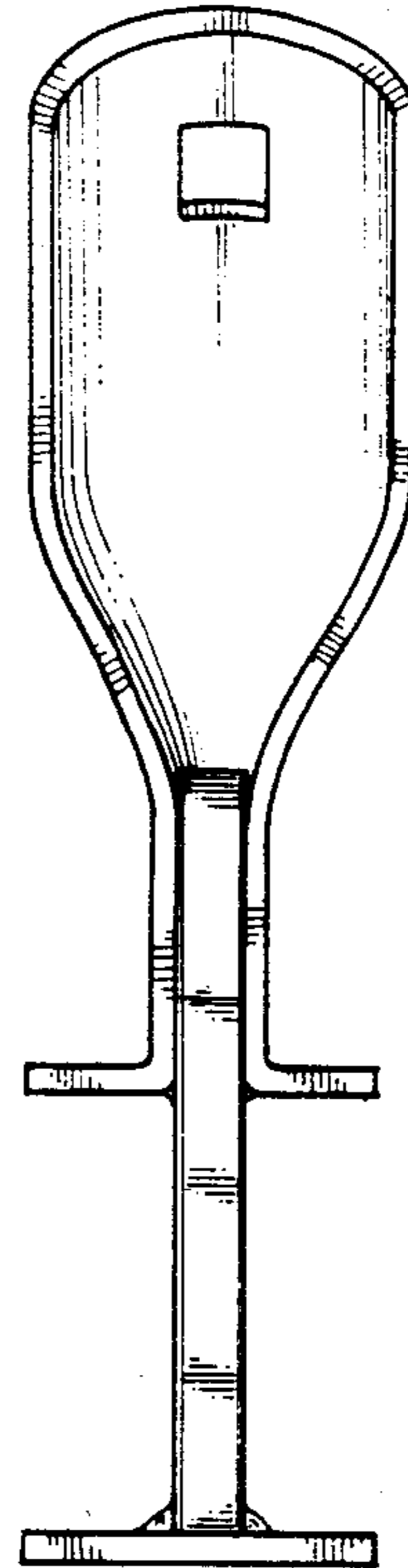

FIG. 8

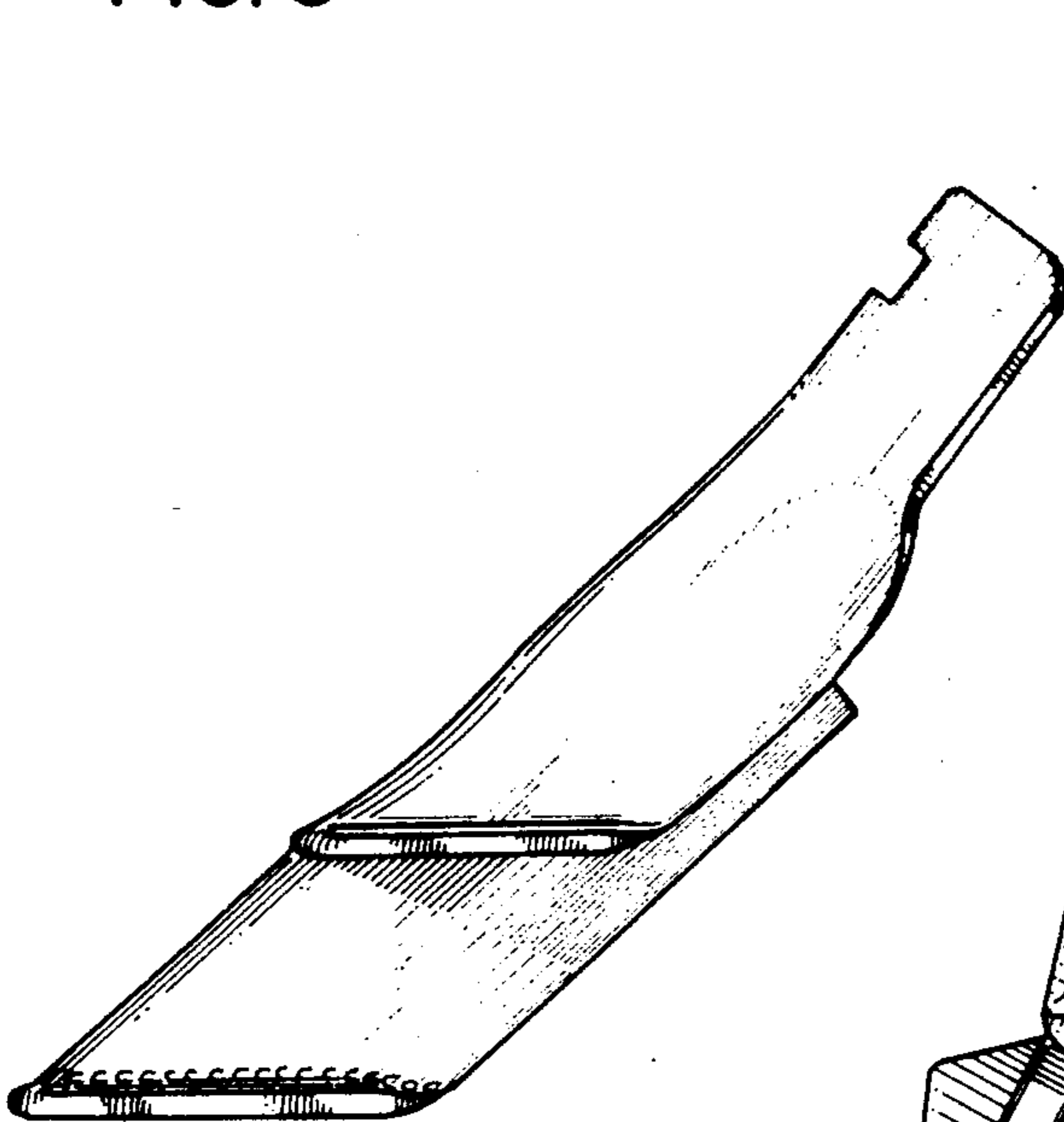

FIG. 9

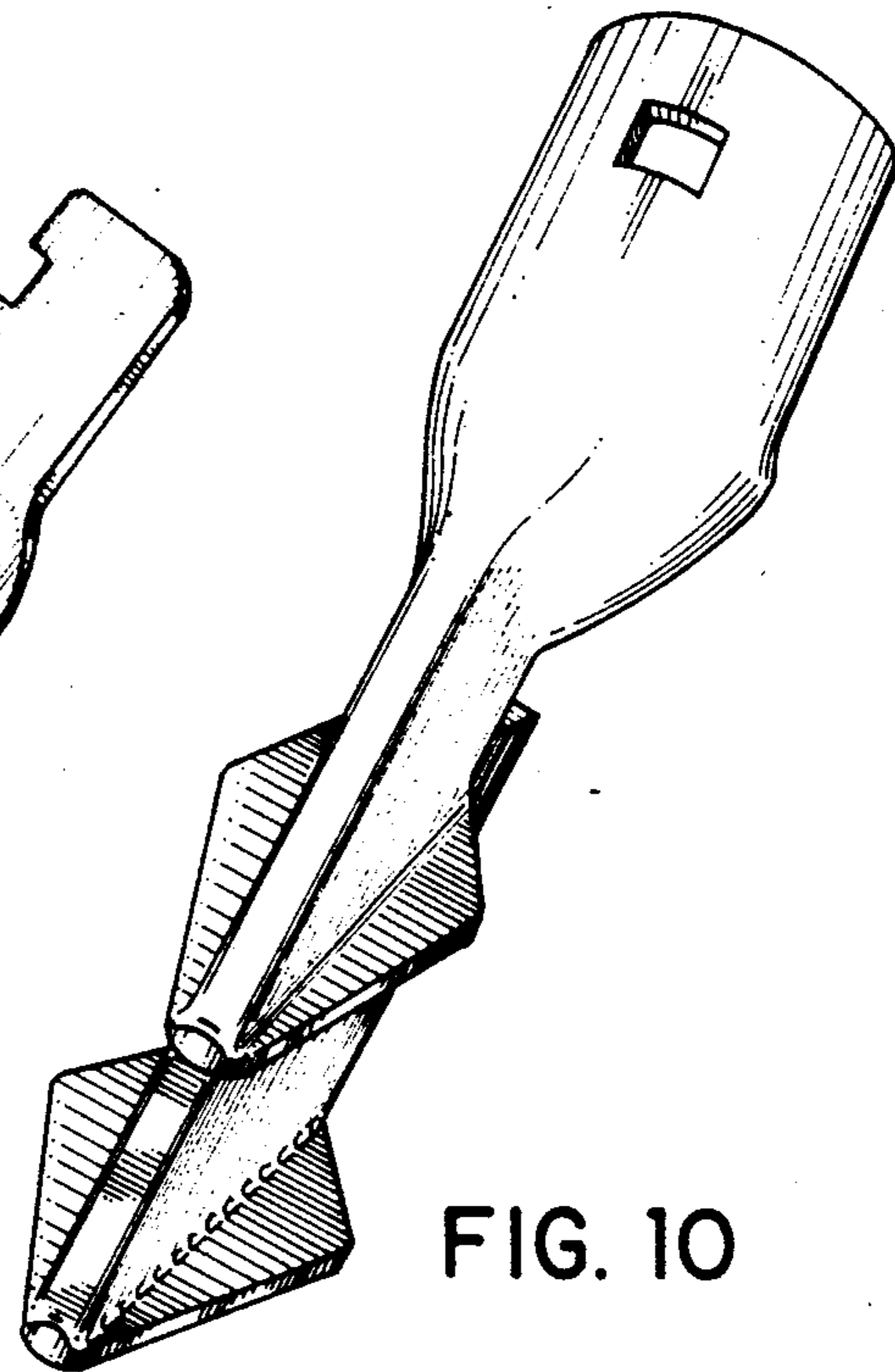

FIG. 10

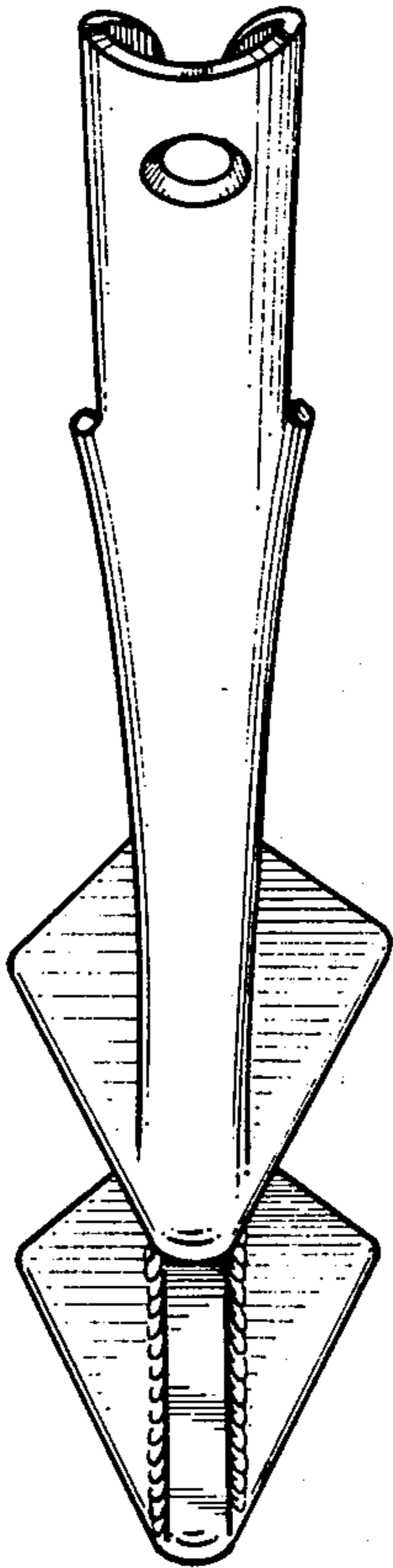

FIG. 11

FIG. 12

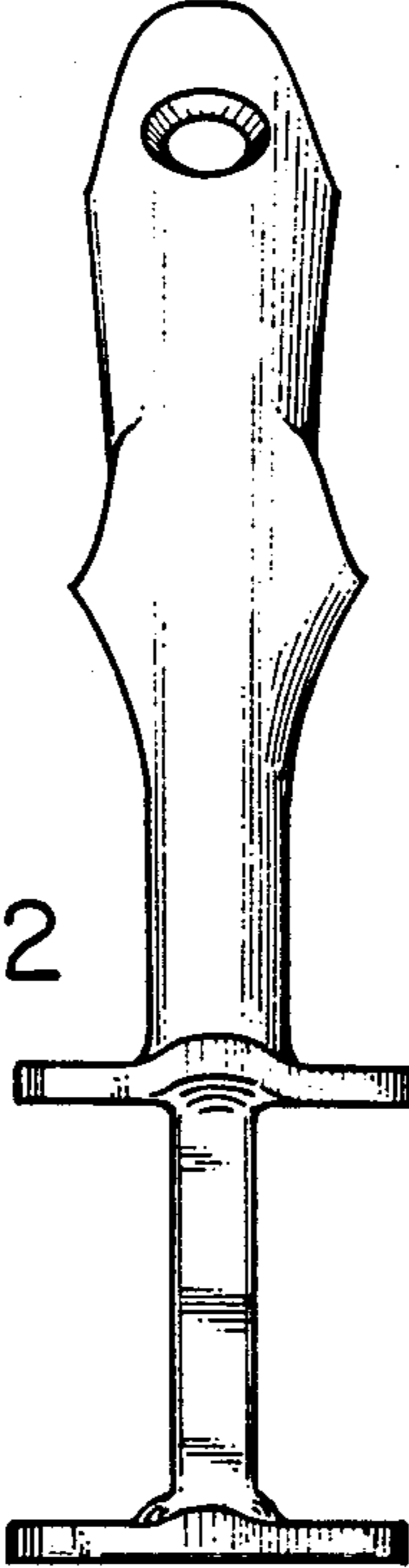

FIG. 13

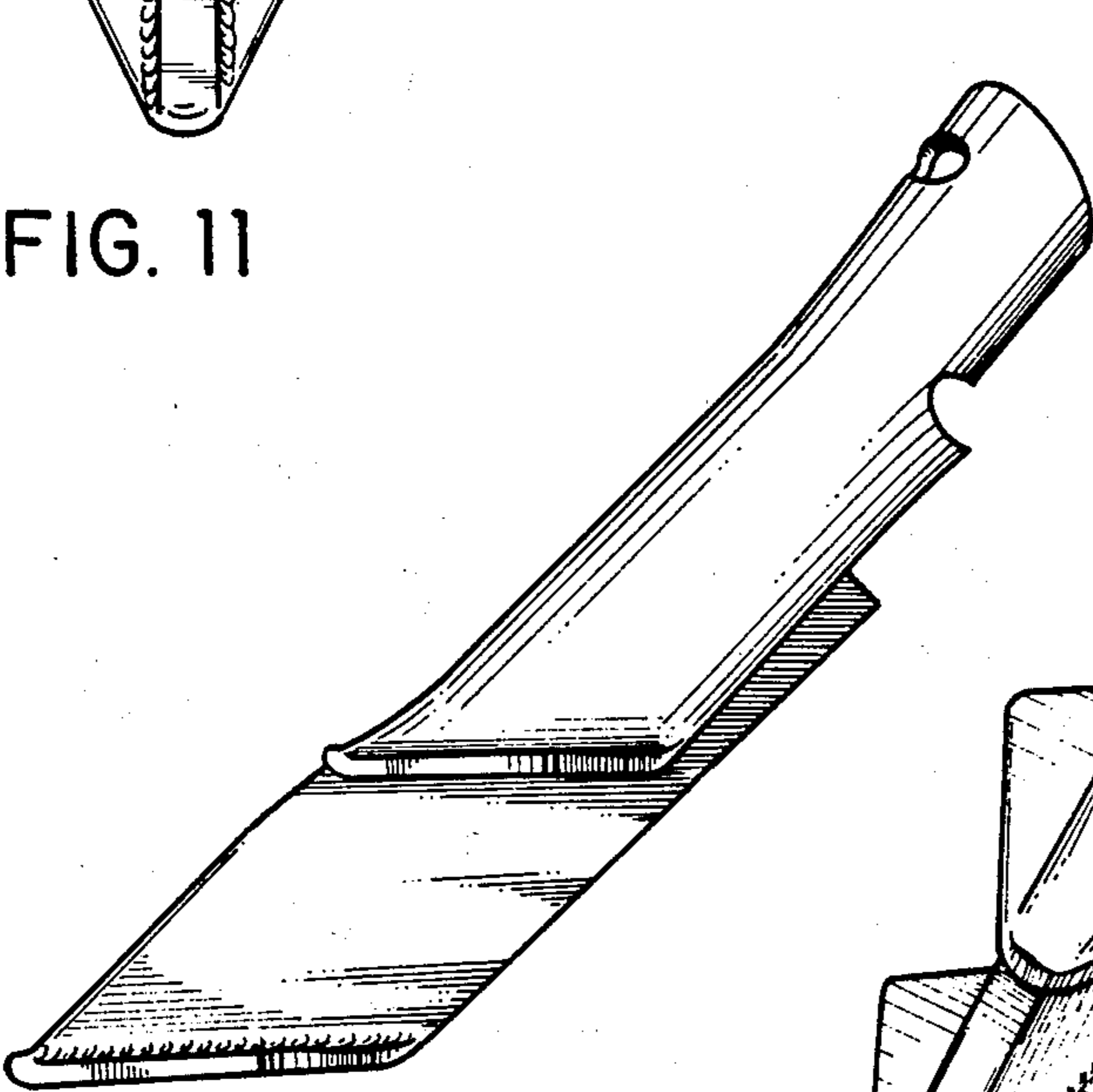
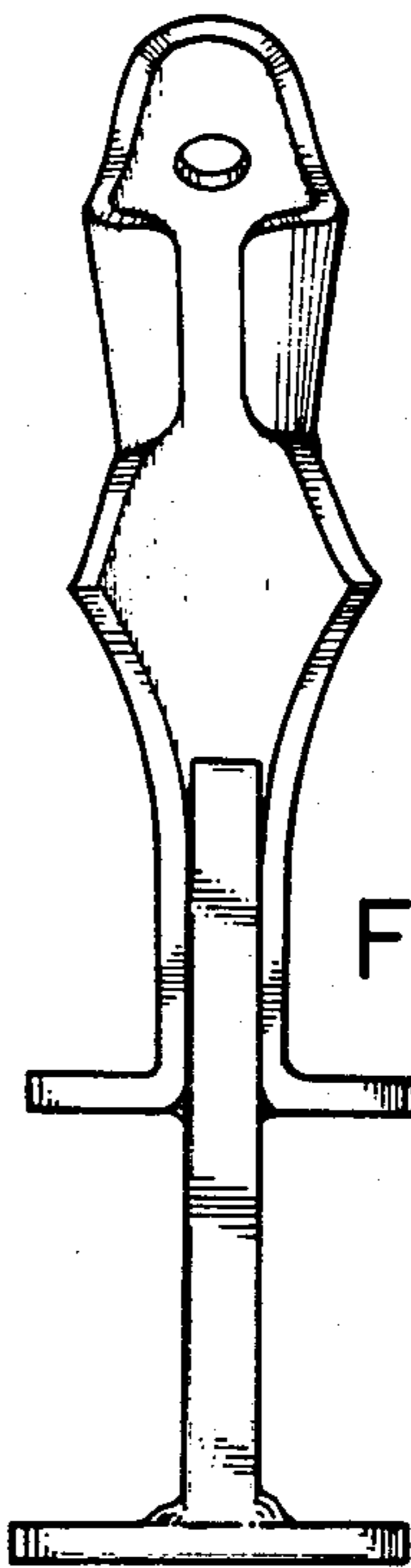

FIG. 14

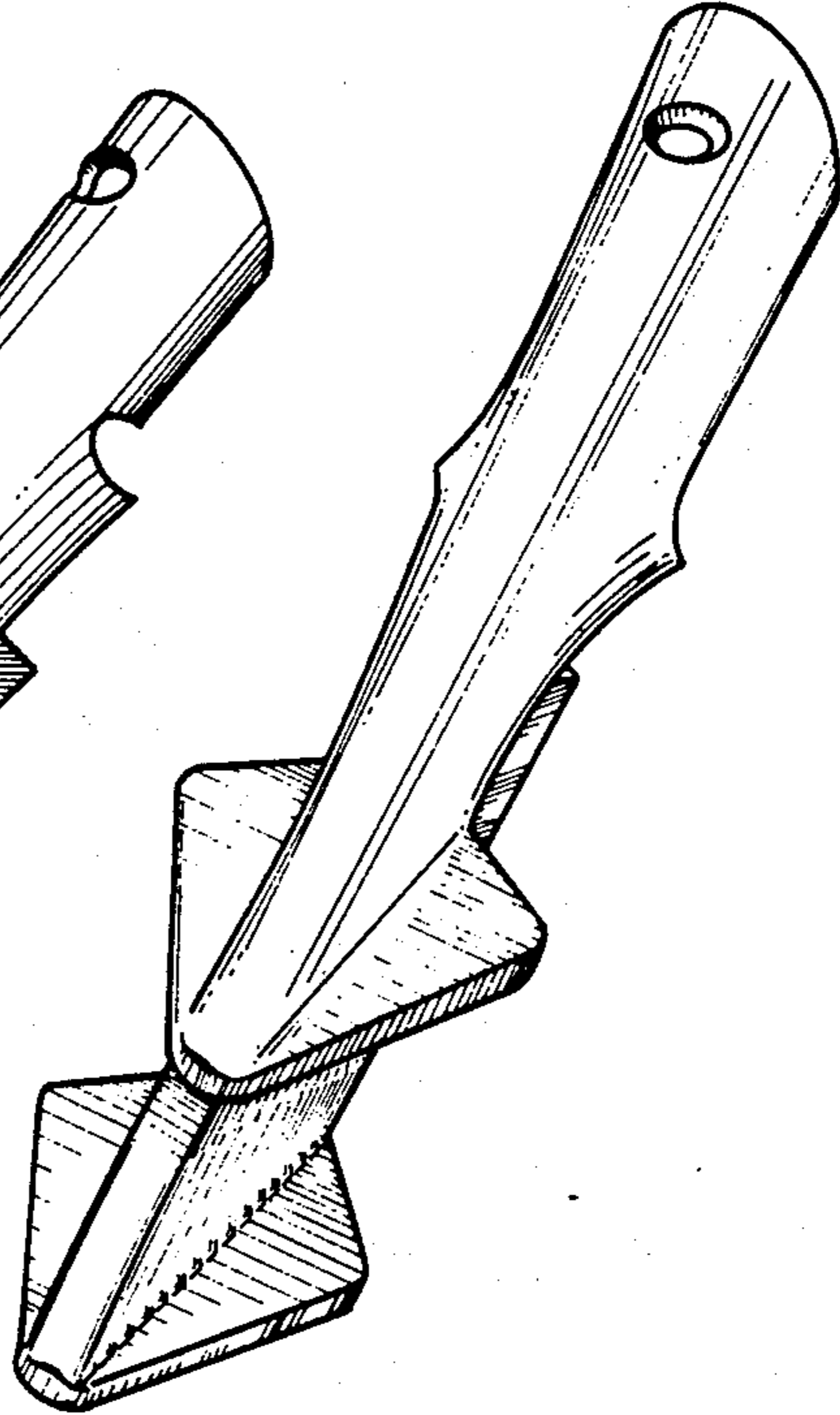

FIG. 15