

[54] ADJUSTABLE COSMETIC APPLICATOR

[76] Inventors: Gino H. Cassai, 924 E. 96th St., Brooklyn, N.Y. 11236; Henry J. Cassai, 163-47 85 St., Howard Beach, N.Y. 11414

[**] Term: 14 Years

[21] Appl. No.: 547,004

[22] Filed: Oct. 31, 1983

[52] U.S. Cl. D28/7

[58] Field of Search D28/4-7, D28/88-90; D9/314, 338, 377, 436; 132/79 A, 83 B, 88.5, 88.7, DIG. 3

[56] References Cited

U.S. PATENT DOCUMENTS

4,165,755 8/1979 Cassai D28/7 X
4,370,989 2/1983 Taylor D28/7 X

OTHER PUBLICATIONS

Drug & Cosmetic Industry, 6/1981, p. 10—Applicator Caps at top center.

Harpers Bazaar, 5/83, p. 5—Revlon Adjustable Angle Mascara.

Primary Examiner—Louis S. Zarfes

[57] CLAIM

The ornamental design for an adjustable cosmetic applicator, as shown and described.

DESCRIPTION

FIG. 1 is a front elevational view of an adjustable cosmetic applicator showing our new design; FIG. 2 is a side elevational view thereof;

FIG. 3 is an elevational view rotated 45% with the tip in an alternate position; FIG. 4 is a top plan view thereof; FIG. 5 is a bottom plan view thereof; FIG. 6 is a front elevational view of an adjustable cosmetic applicator showing a second embodiment of our new design wherein the container top handle design is modified; FIG. 7 is a side elevational view thereof; FIG. 8 is an elevational view rotated 45% with the tip in an alternate position; FIG. 9 is a top plan view of an adjustable cosmetic applicator showing a third embodiment of our new design wherein the tip is modified; FIG. 10 is a top plan view of an adjustable cosmetic applicator showing a fourth embodiment of our new design with another modification of the tip; FIG. 11 is a top plan view of an adjustable cosmetic applicator showing a fifth embodiment of our new design wherein the ball socket receptacle is modified; FIG. 12 is a side elevational view showing FIG. 1 with embodiment modification FIG. 11; FIG. 13 is another side elevational view showing FIG. 6 with embodiment modification FIG. 11; FIG. 14 is a top plan view of an adjustable cosmetic applicator showing a sixth embodiment of our new design with another ball socket receptacle modification; FIG. 15 is a side elevational view showing FIG. 1 with embodiment modification FIG. 14; FIG. 16 is another side elevational view showing FIG. 6 with embodiment modification FIG. 14; FIG. 17 is a side elevational view of adjustable cosmetic applicator FIG. 1, showing a seventh embodiment of our new design wherein the tip is extended; and FIG. 18 is another side elevational view showing FIG. 6 with embodiment modification FIG. 17.

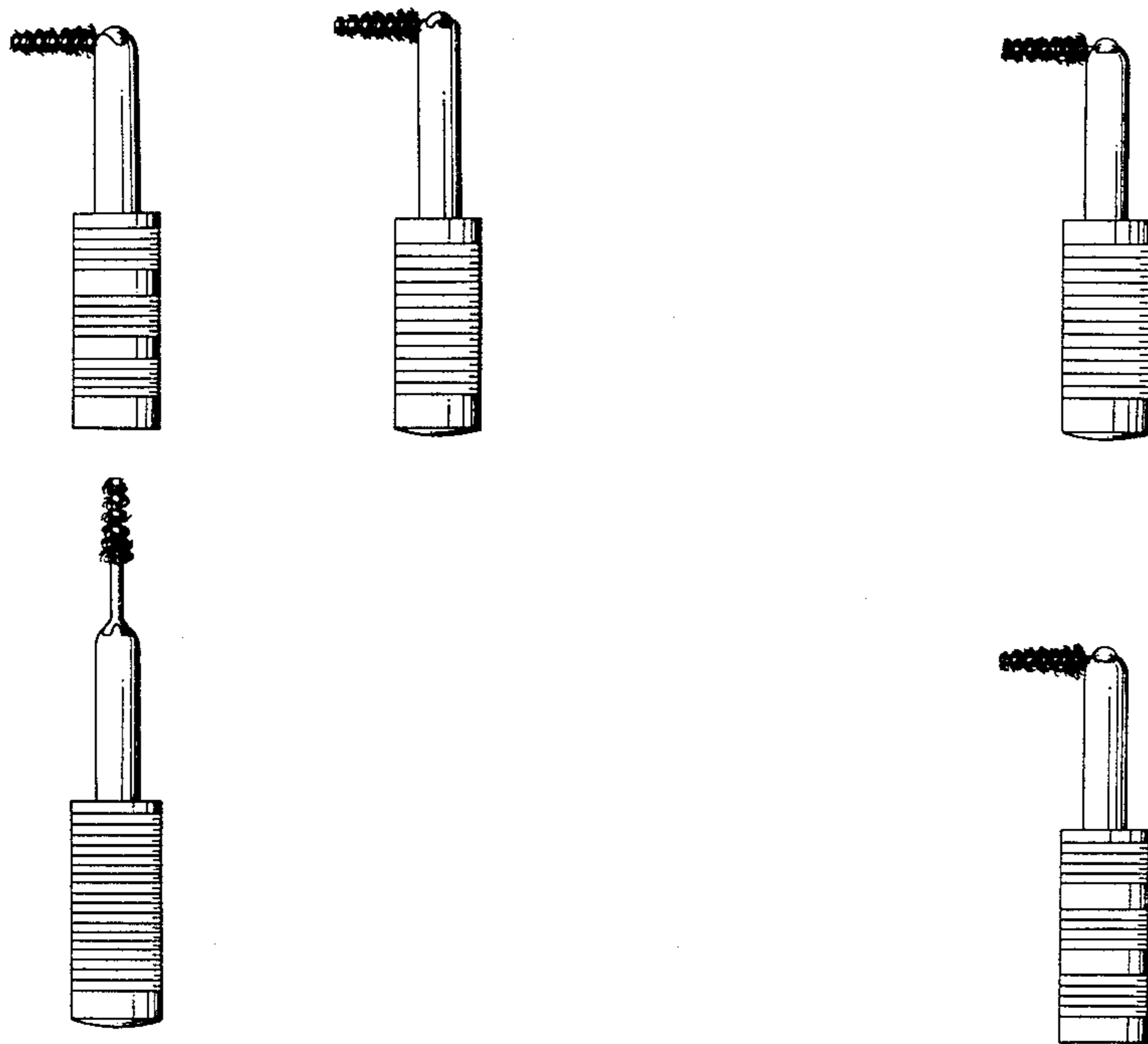

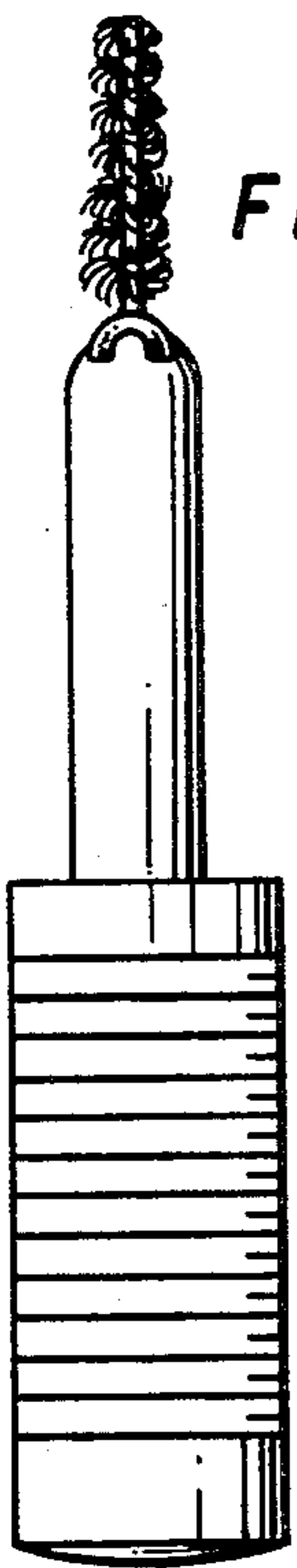

FIG. 1

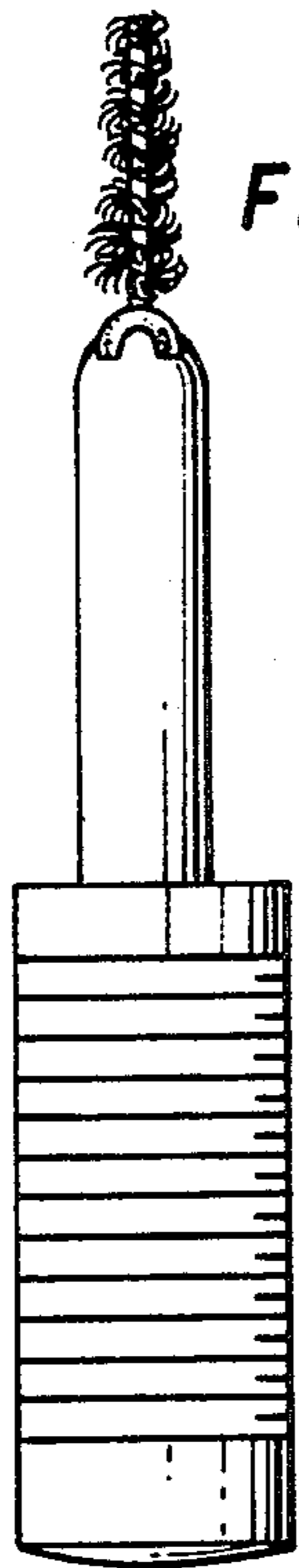

FIG. 2

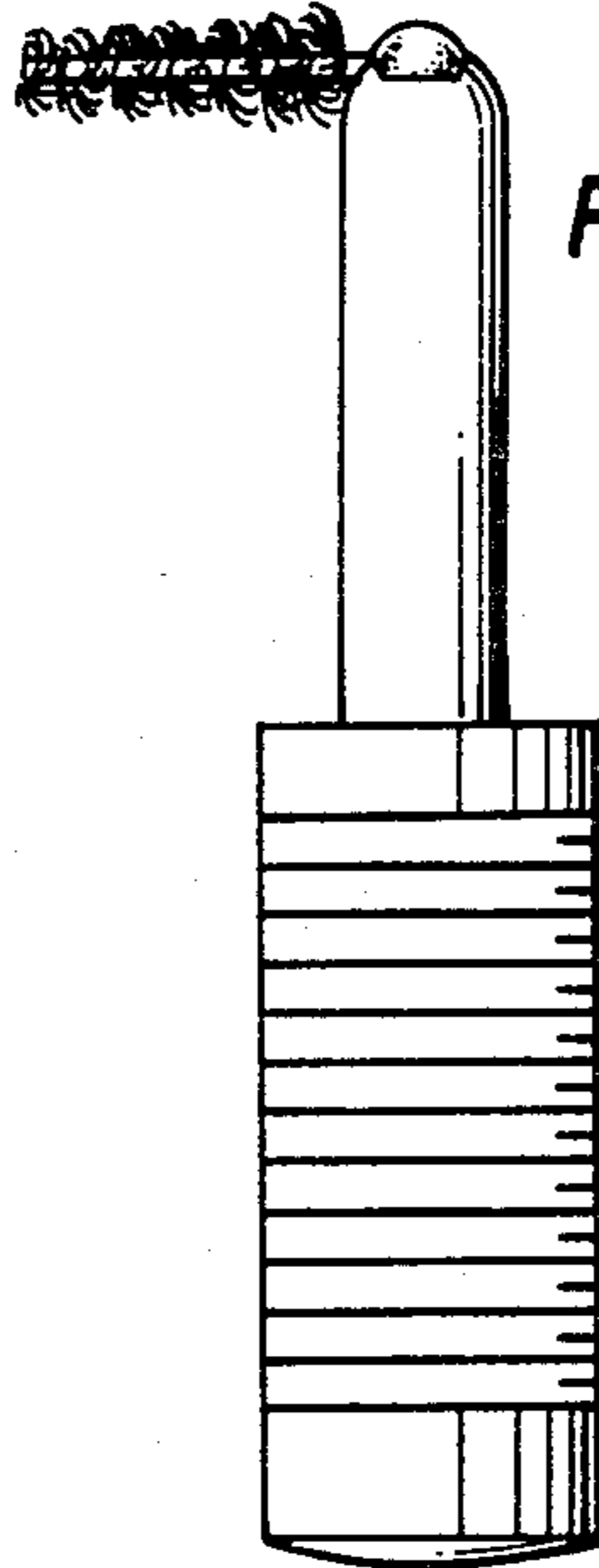

FIG. 3

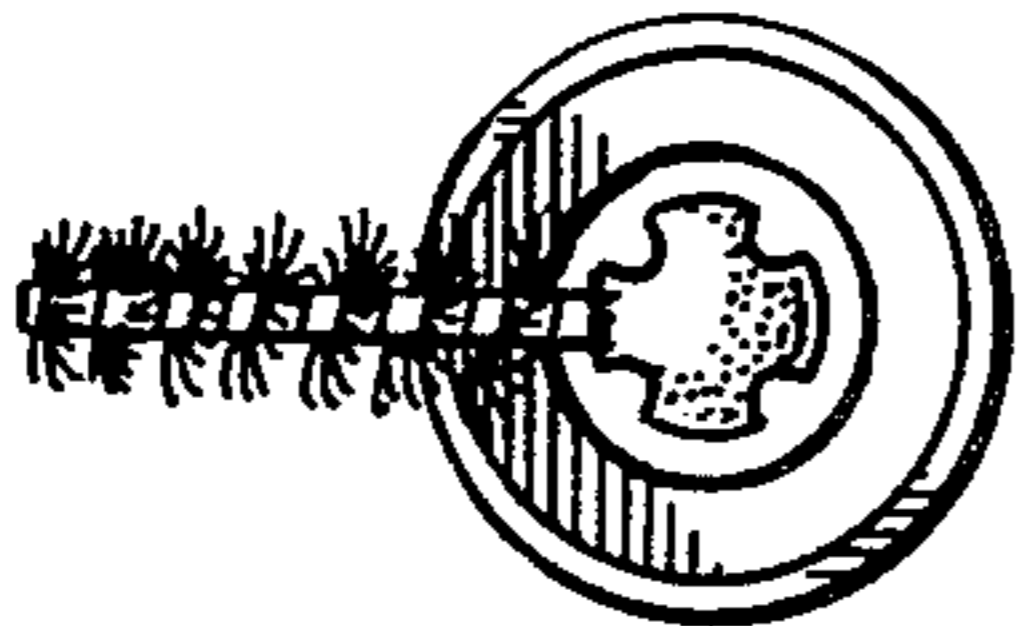

FIG. 4

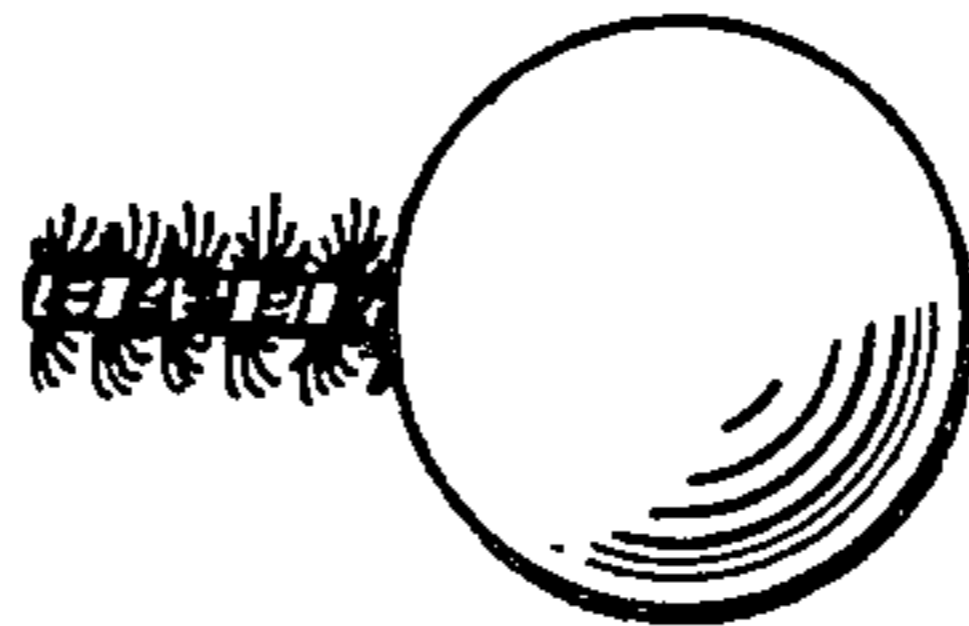

FIG. 5

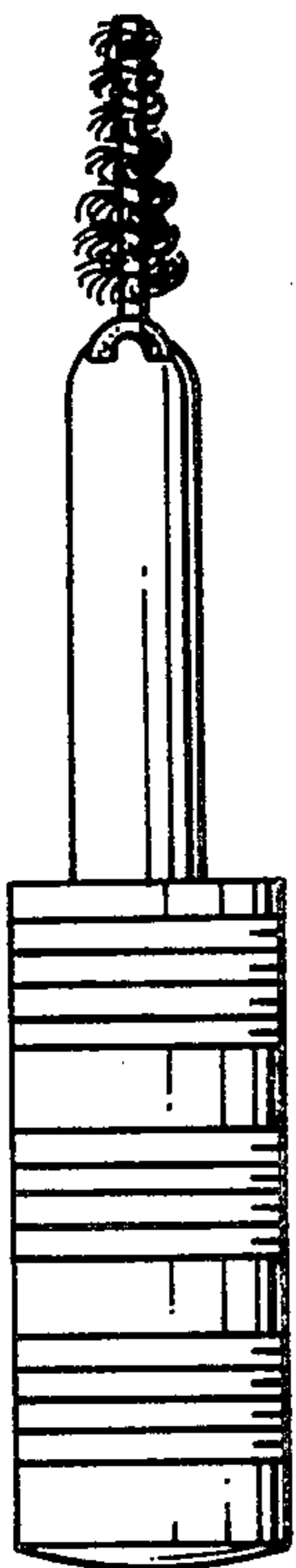

FIG. 6

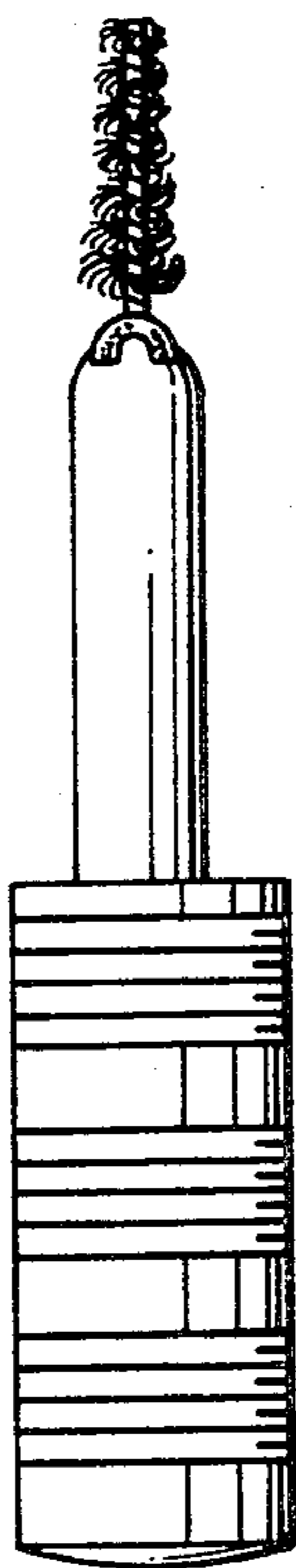

FIG. 7

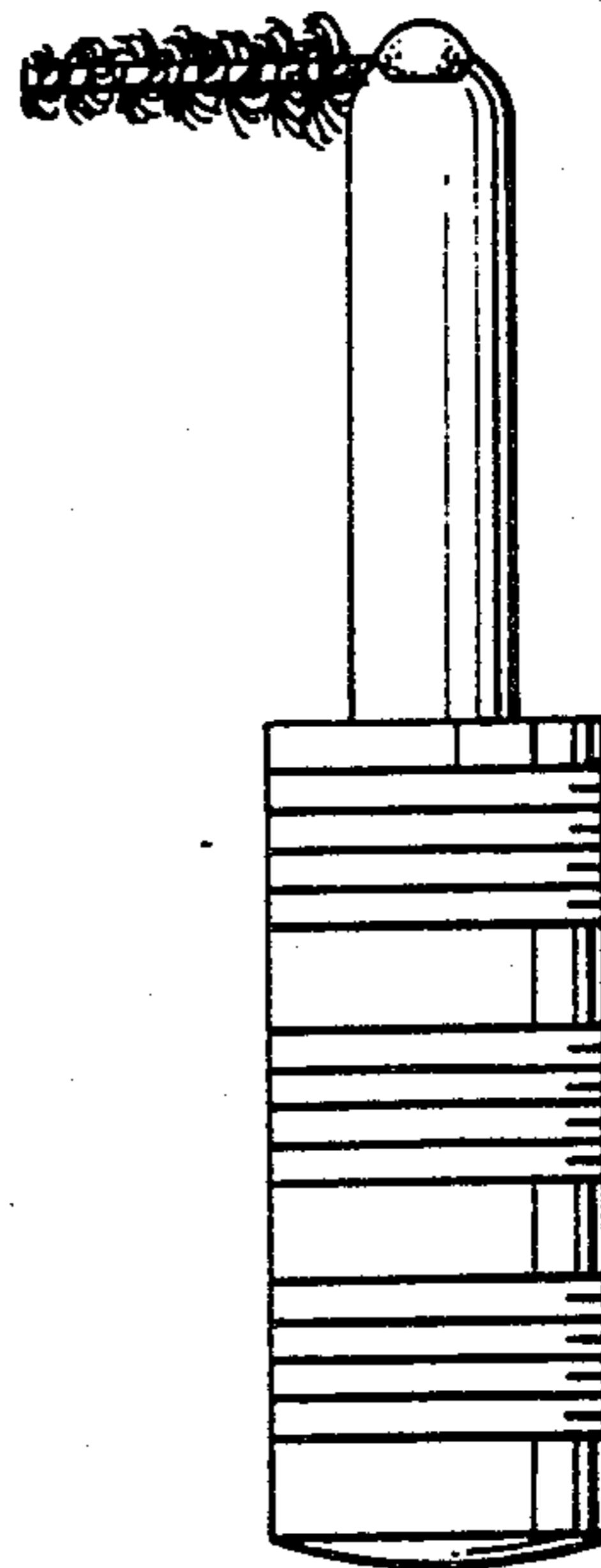

FIG. 8

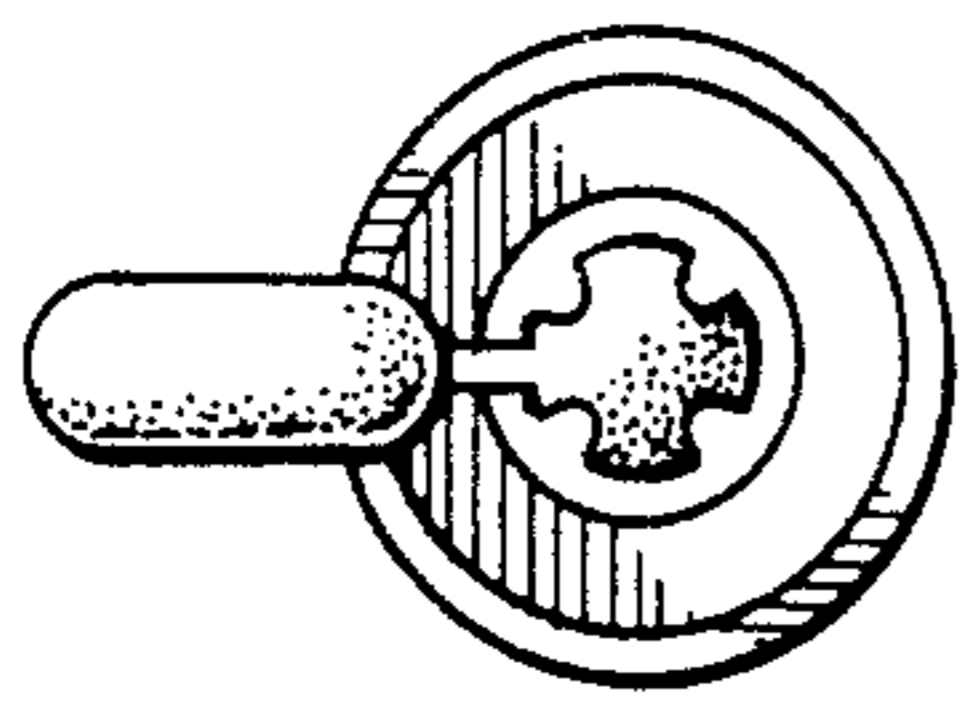

FIG. 9

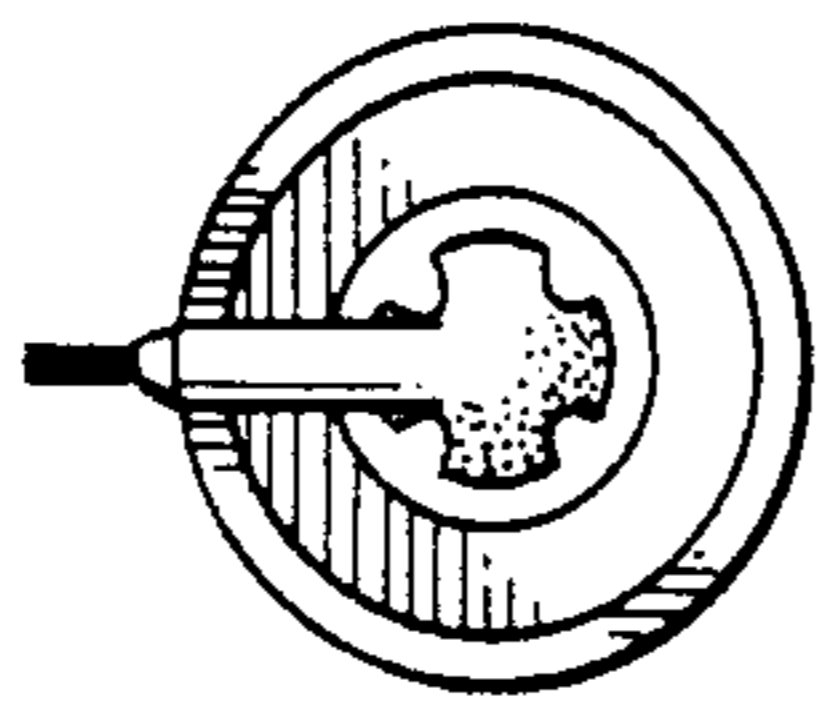

FIG. 10

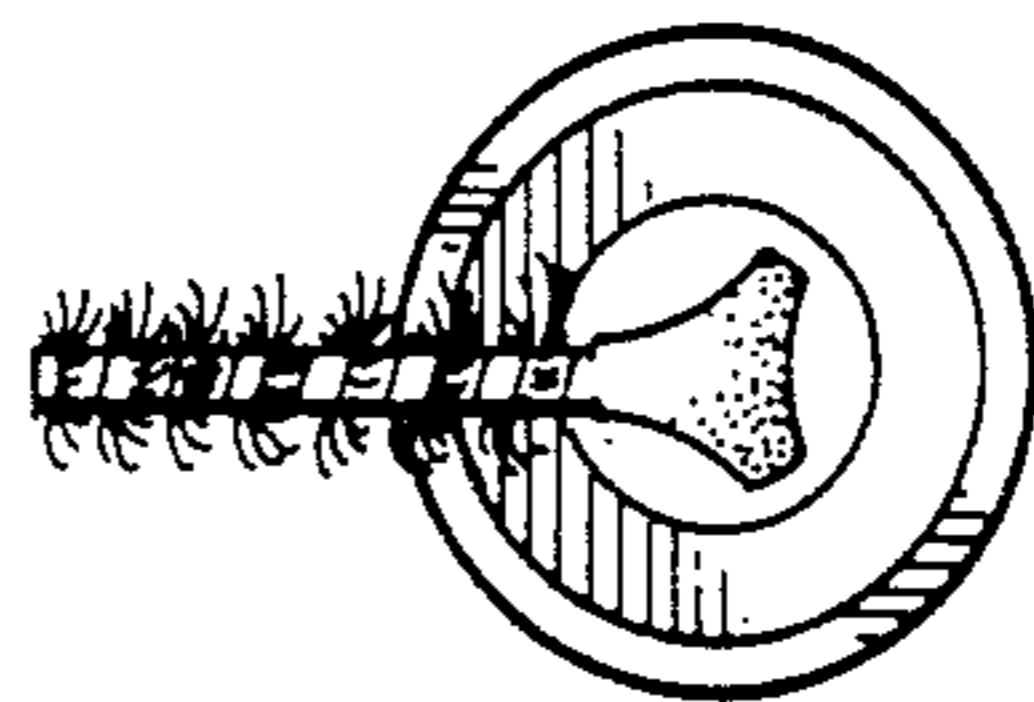

FIG. 11

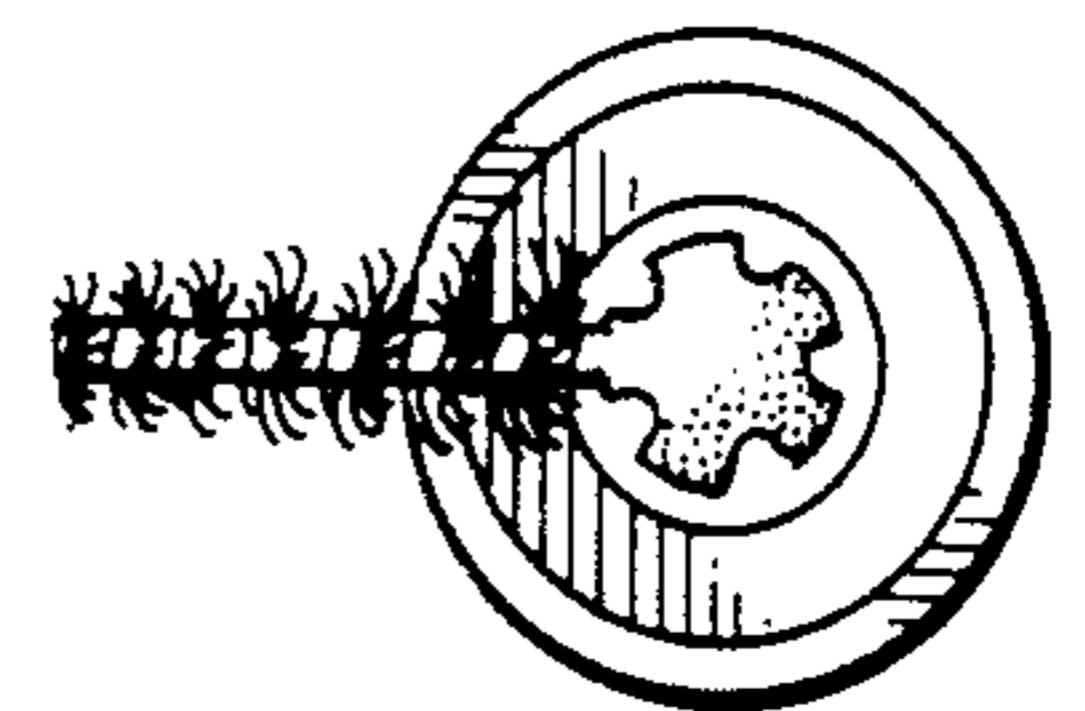

FIG. 14

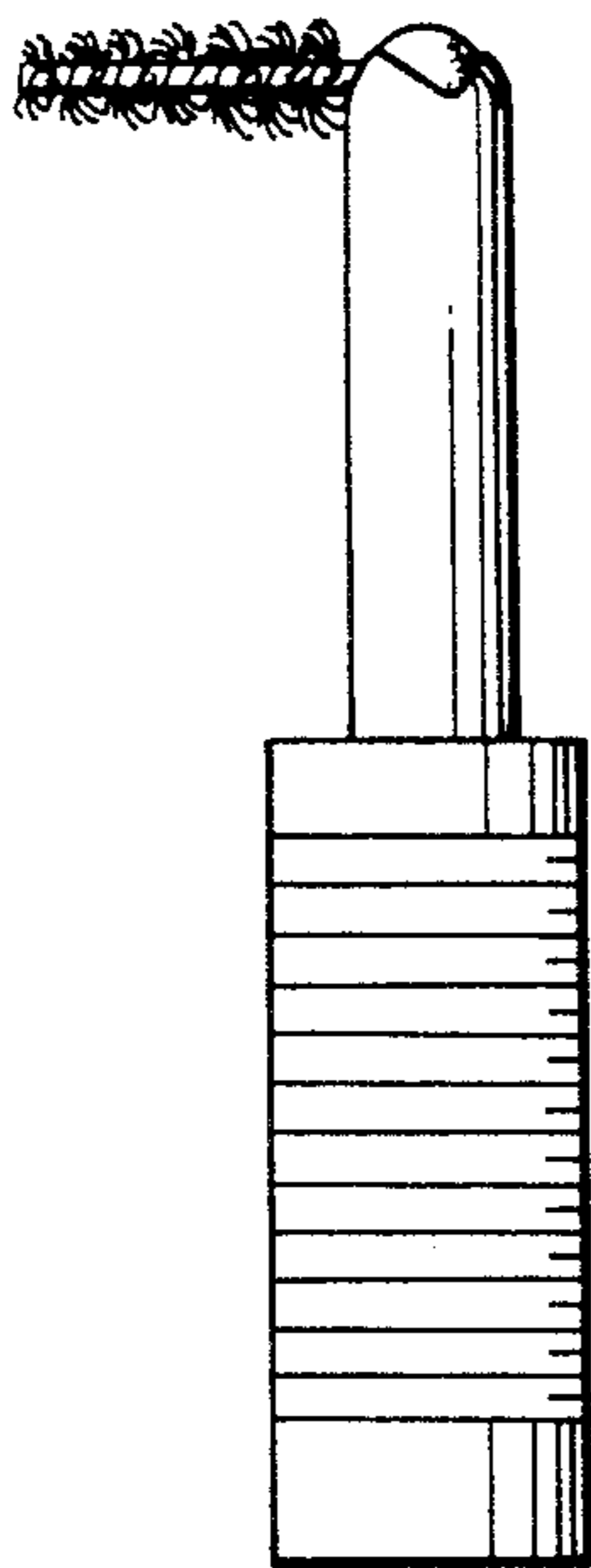

FIG. 12

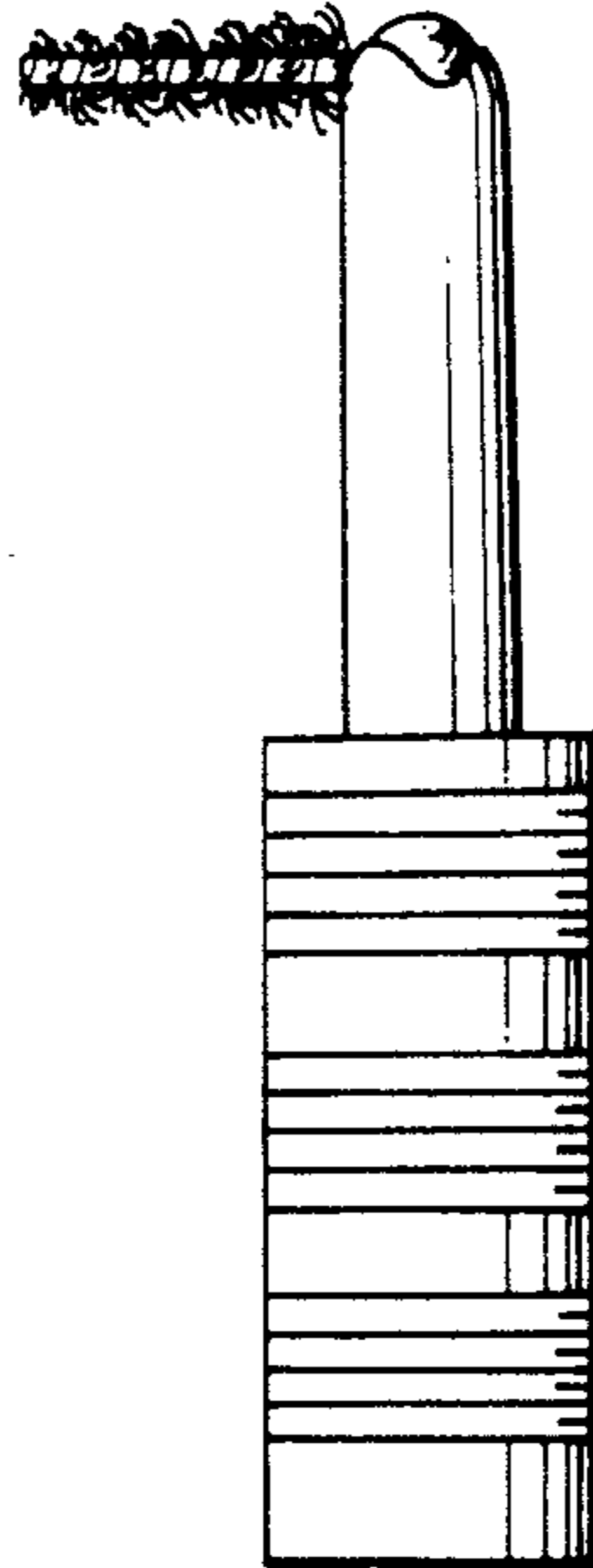

FIG. 13

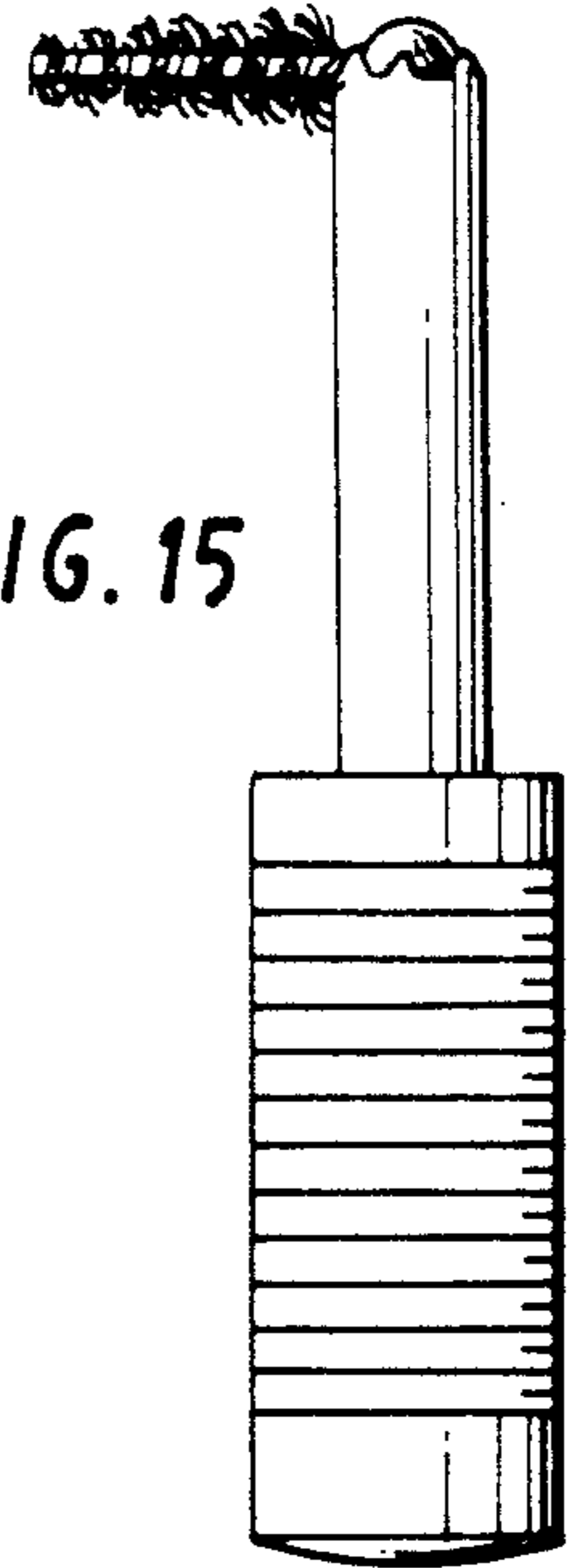

FIG. 15

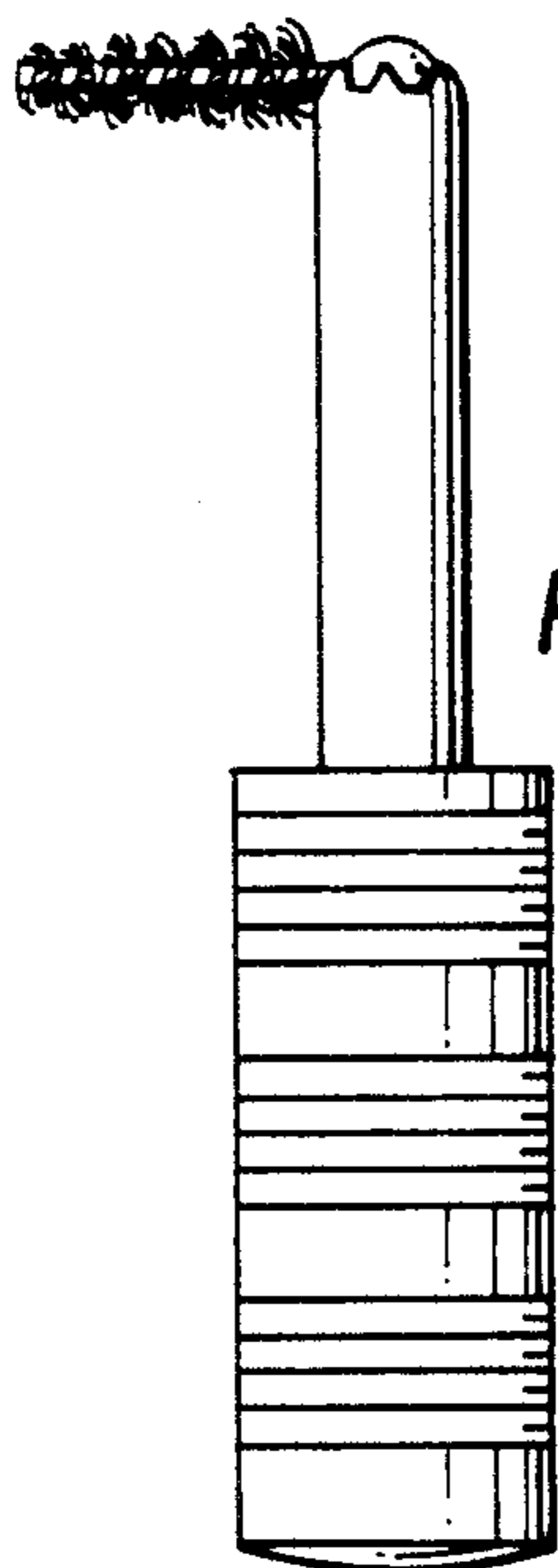

FIG. 16

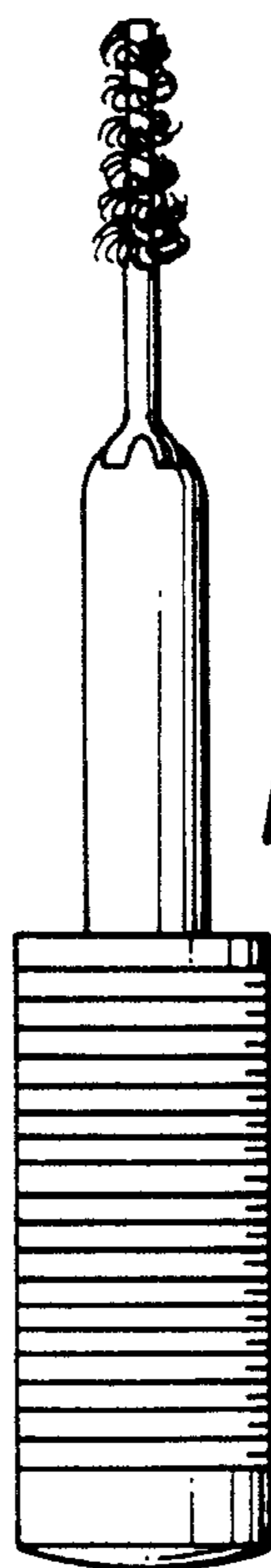

FIG. 17

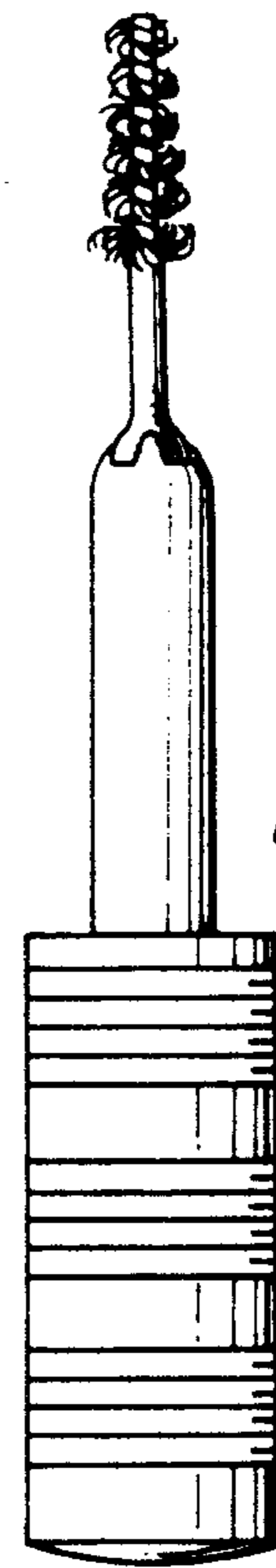

FIG. 18