

[54] EYEGLASSES

[76] Inventor: Barton M. Levoy, 130 Cutter Mill Rd., Great Neck, N.Y. 11022

[**] Term: 14 Years

[21] Appl. No.: 638,035

[22] Filed: Aug. 6, 1984

[52] U.S. Cl. D16/102; D16/116

[58] Field of Search D16/102-122, D16/123, 125, 127; D2/234; 351/41, 43, 47, 51-53, 60, 63, 66, 68, 78, 81, 83, 85, 87, 90-93, 95, 98, 102-104, 111, 113, 123, 125, 127

[56] References Cited

U.S. PATENT DOCUMENTS

D. 220,405 4/1971 Tagnon D16/115

OTHER PUBLICATIONS

Optical Journal and Review of Optometry, 4-1-1966, p.

12, Style S500 Frames by Victory Suntimers/Copy in "Specs." Publ. Boxes-290.

The Optician, 2-25-83, p. 21, "Mr. R" Frames by Rodenstock, Copy in Spectacles.

Optometric Monthly, Apr. 1983, p. 217, Versailles II, Shape B Frames-Copy in "Specs."

Primary Examiner—Susan J. Lucas

Assistant Examiner—Clare E. Heflin

Attorney, Agent, or Firm—Bauer & Amer

[57] CLAIM

The ornamental design for eyeglasses, as shown and described.

DESCRIPTION

FIG. 1 is a top plan view of the eyeglasses showing my new design;

FIG. 2 is a front elevational view thereof;

FIG. 3 is a right side elevational view thereof;

FIG. 4 is a bottom plan view thereof;

FIG. 5 is a rear elevational view thereof; and

FIG. 6 is a left side elevational view thereof.

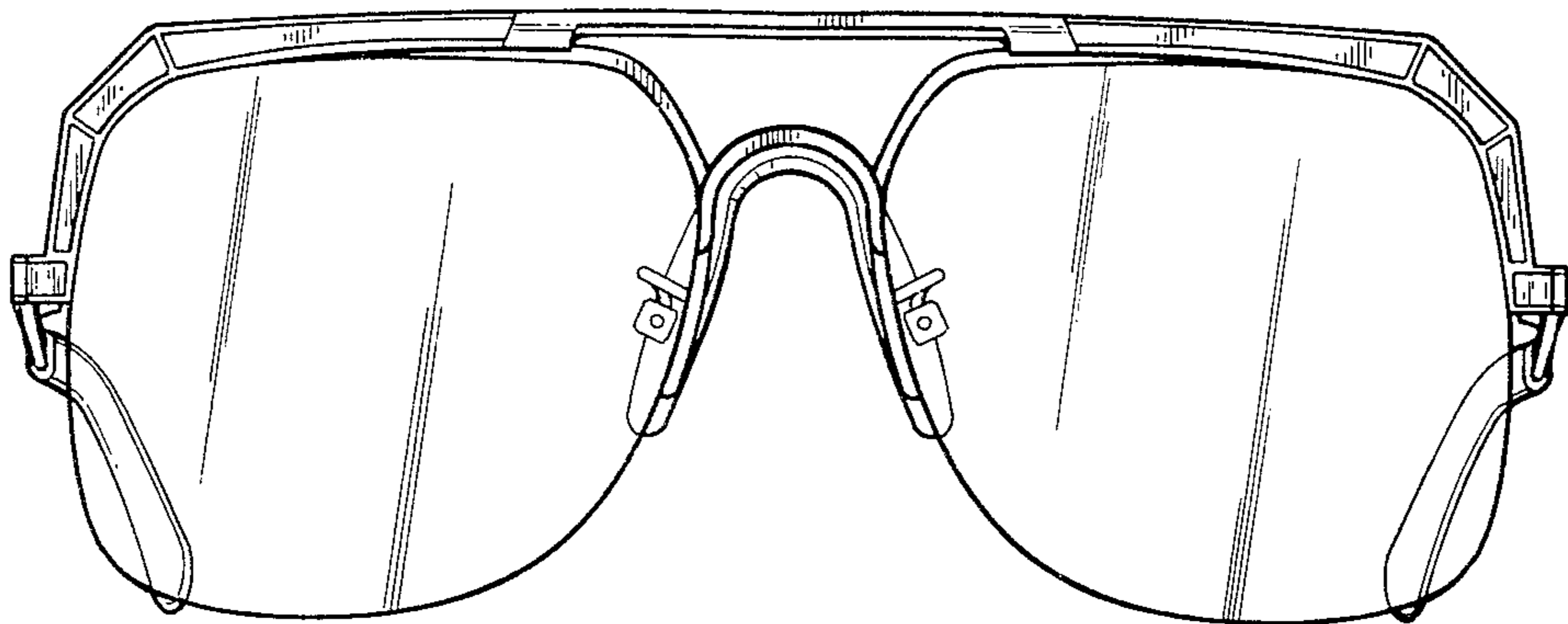

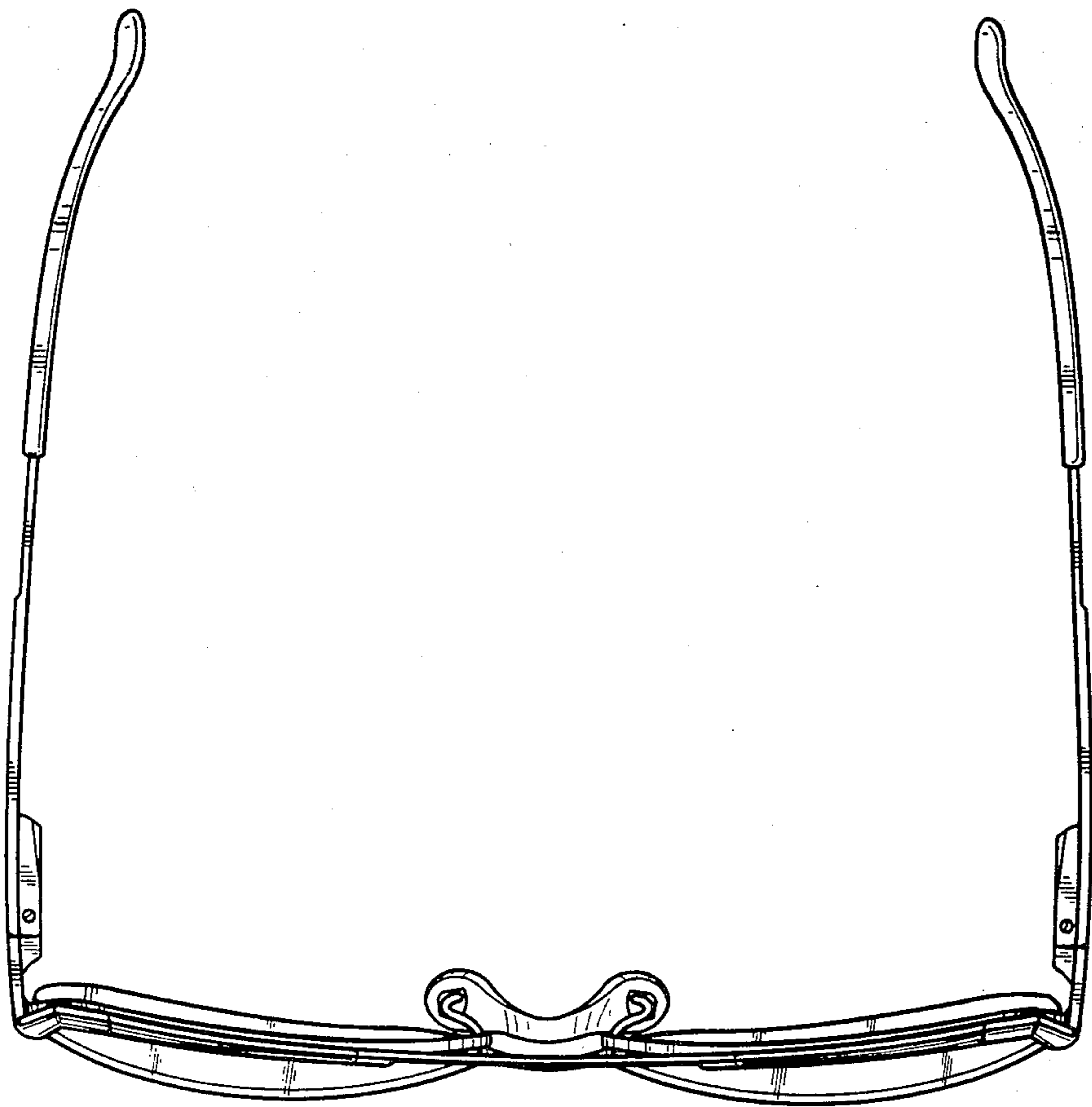

FIG. 1

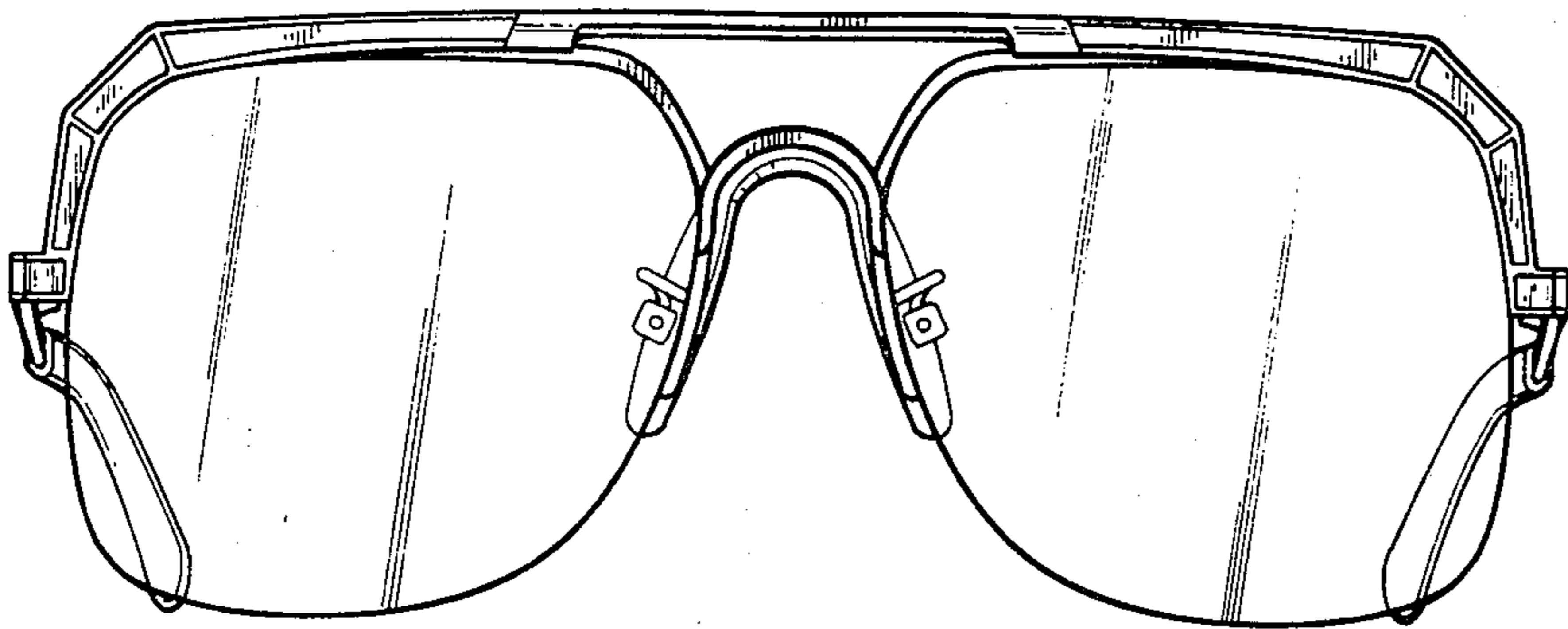

FIG. 2

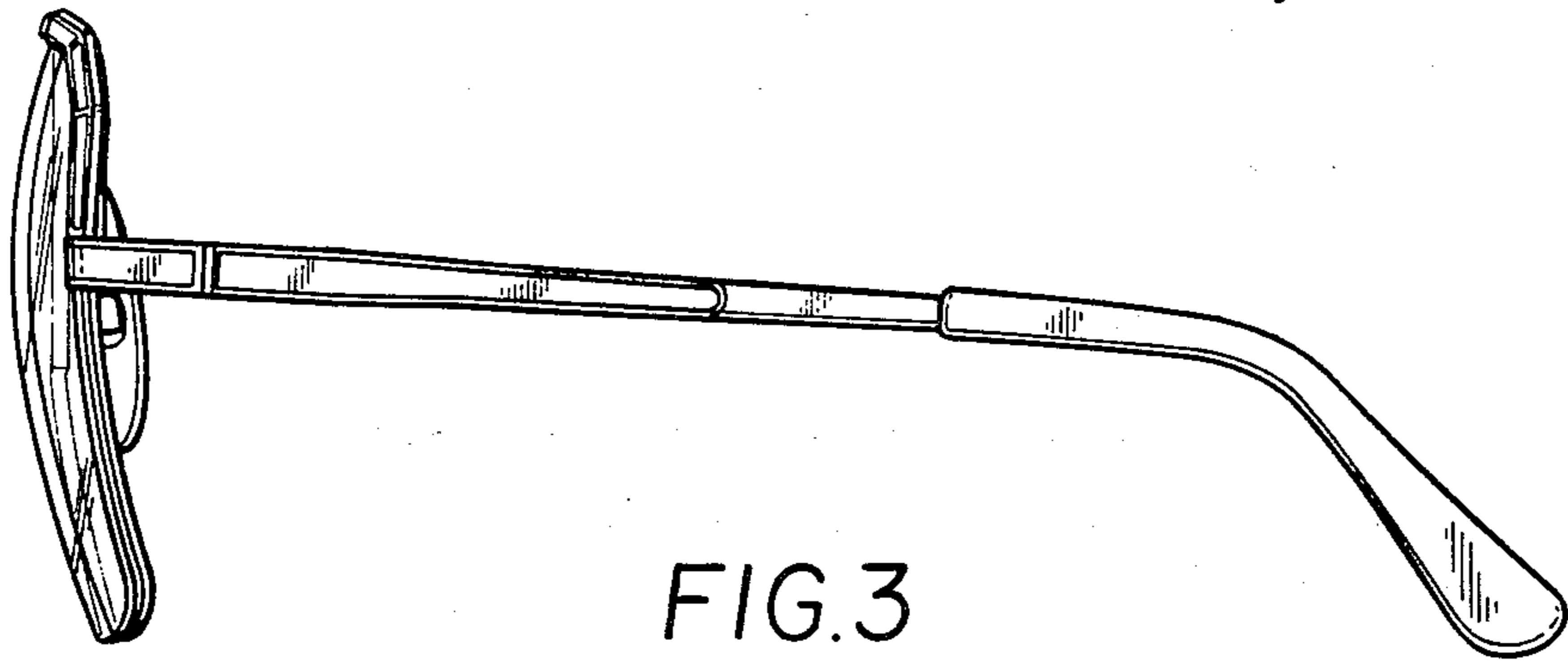

FIG. 3

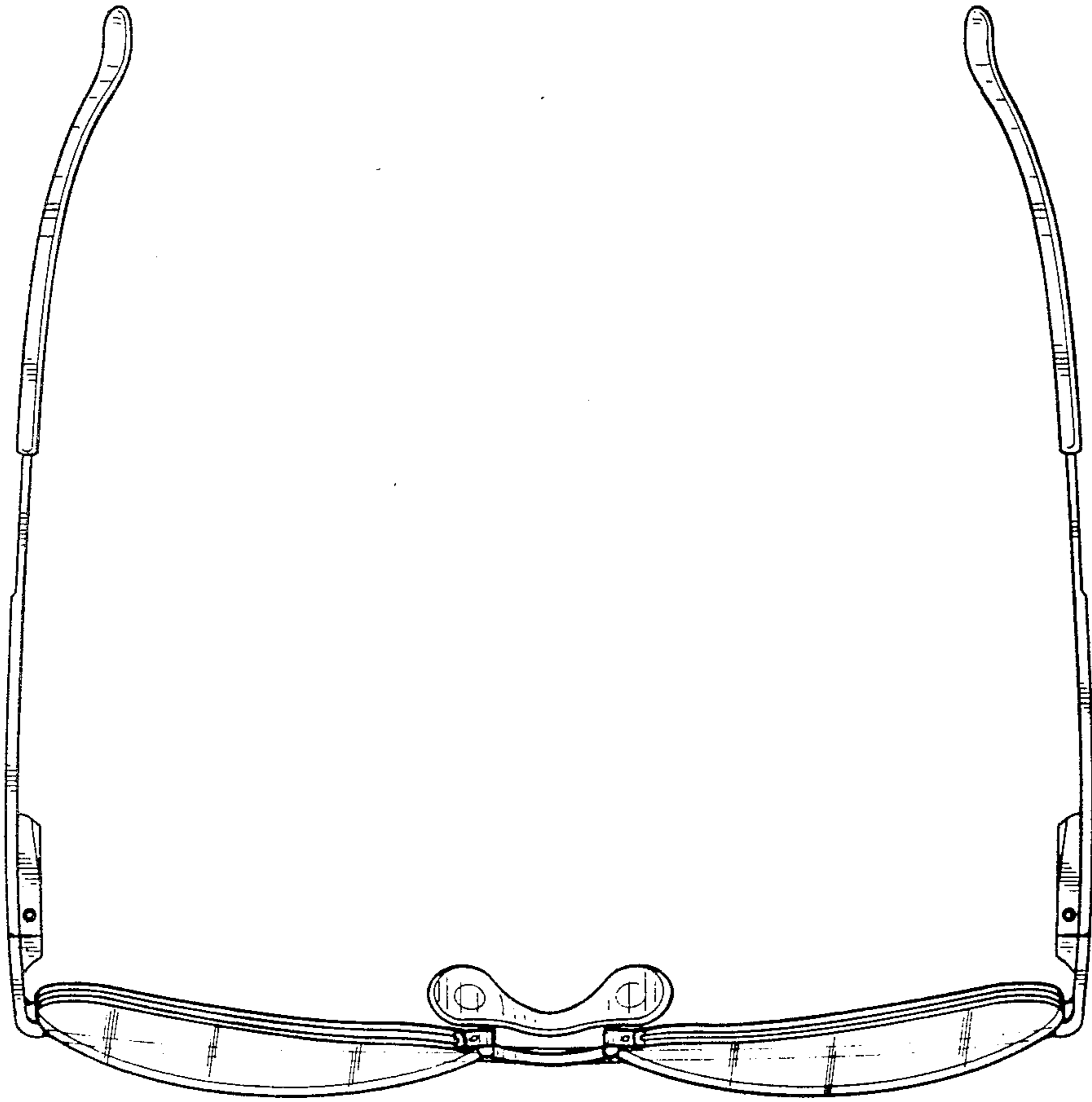

FIG. 4

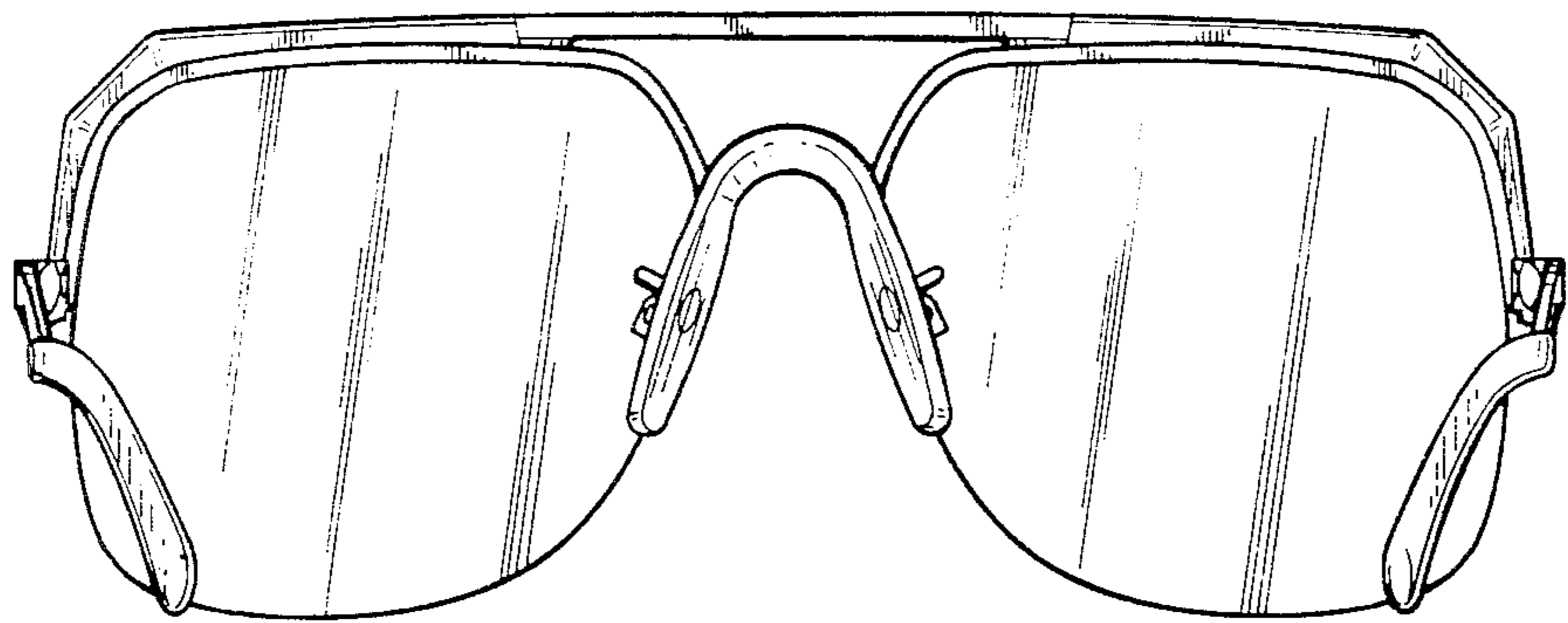

FIG. 5

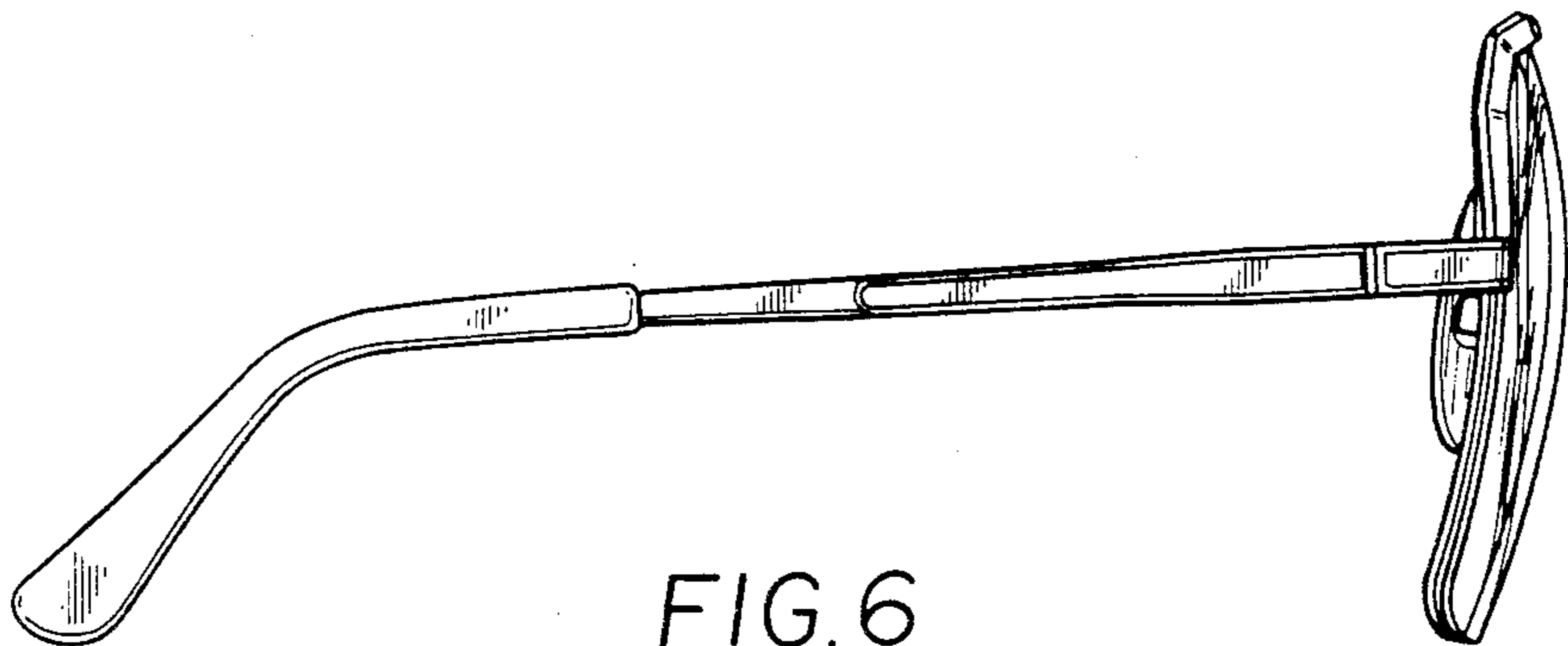

FIG. 6