

[54] GARDEN SPRAYER BODY OR A SIMILAR ARTICLE

[75] Inventor: Kazuharu Nakamura, Nagoya, Japan

[73] Assignee: Toyotomi Kogyo Co., Ltd., Aichi, Japan

[**] Term: 14 Years

[21] Appl. No.: 525,588

[22] Filed: Aug. 23, 1983

[30] Foreign Application Priority Data

Feb. 23, 1983 [JP] Japan 58-7453

[52] U.S. Cl. D23/18; D9/376

[58] Field of Search D23/17, 18; 239/152, 239/153, 302, 588; D9/376, 411

[56] References Cited

U.S. PATENT DOCUMENTS

- D. 195,280 5/1963 Bodenheimer D9/376
- D. 196,198 9/1963 Corning et al. D23/18
- D. 210,569 3/1968 Kelly D9/376
- D. 212,350 10/1968 Kelly D9/376
- D. 254,321 2/1980 Sidor et al. D23/18

- D. 272,380 1/1984 Poon D23/18
- 2,162,057 6/1939 Brandt et al. D23/18 X
- 3,168,984 2/1965 Corning et al. 239/333
- 3,199,739 8/1965 Corning et al. 239/333 X
- 3,901,449 8/1975 Bochmann 239/333
- 3,993,250 11/1976 Shure 239/333 X

FOREIGN PATENT DOCUMENTS

- 489202 11/1978 Japan .
- 517993 12/1979 Japan .

Primary Examiner—James R. Largent
Attorney, Agent, or Firm—Pollock, Vande Sande & Priddy

[57] CLAIM

The ornamental design for a garden sprayer body or a similar article, substantially as shown and described.

DESCRIPTION

FIG. 1 is a left side elevational view of a garden sprayer body showing my new design;
FIG. 2 is a front elevational view thereof;
FIG. 3 is a right side elevational view thereof;
FIG. 4 is a rear elevational view thereof;
FIG. 5 is a top plan view thereof; and,
FIG. 6 is a bottom plan view thereof.

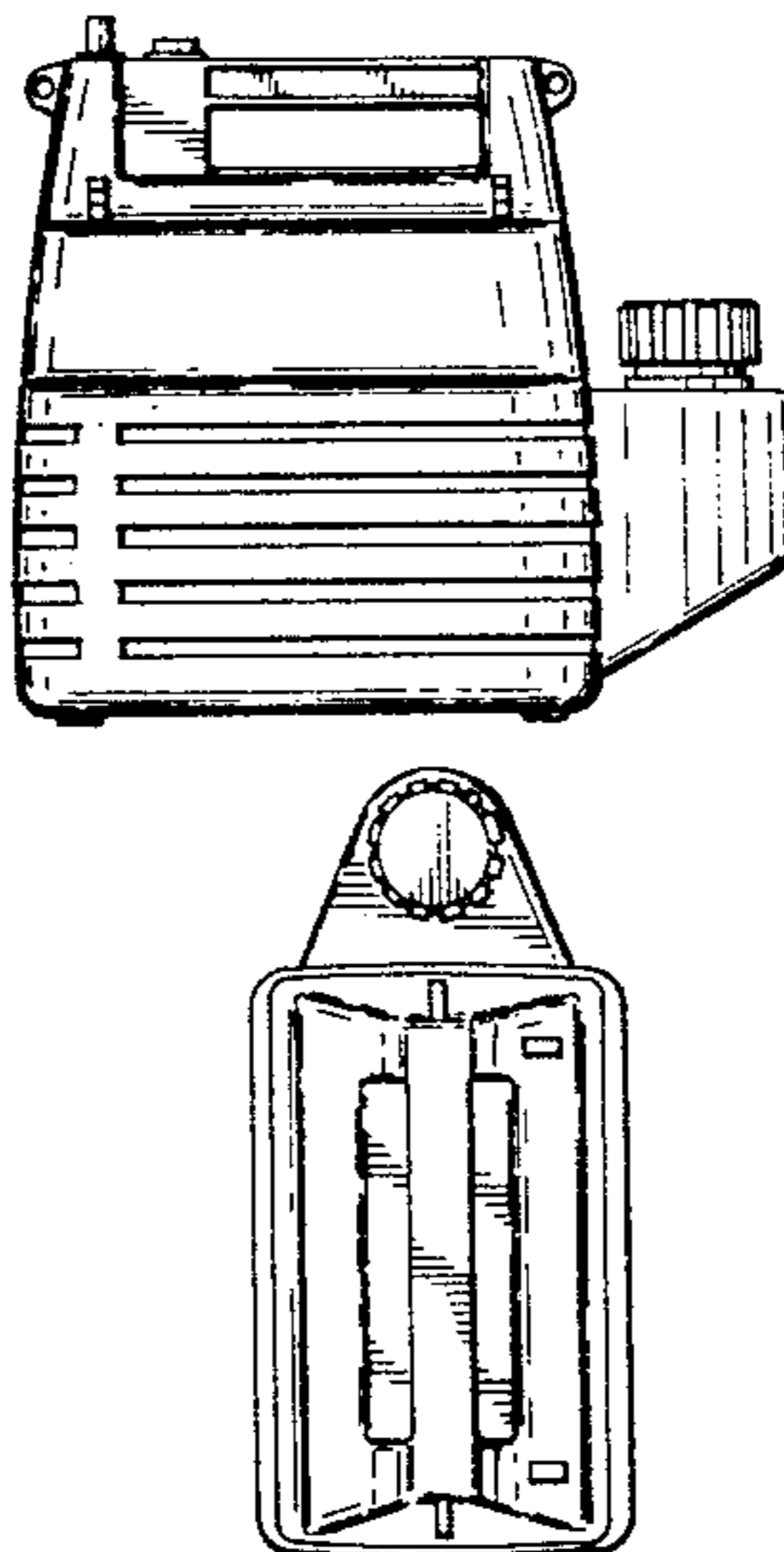

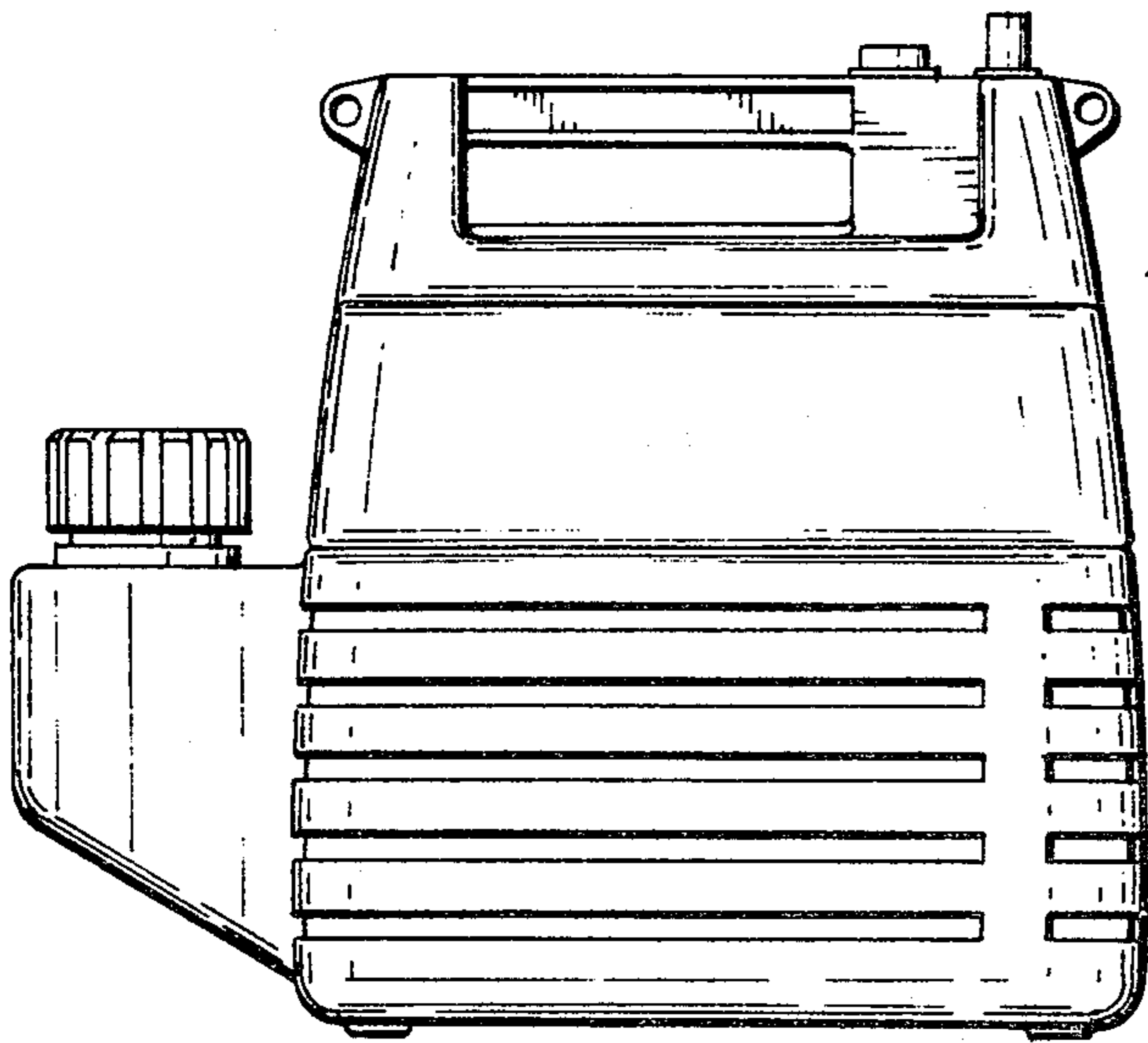

FIG 1

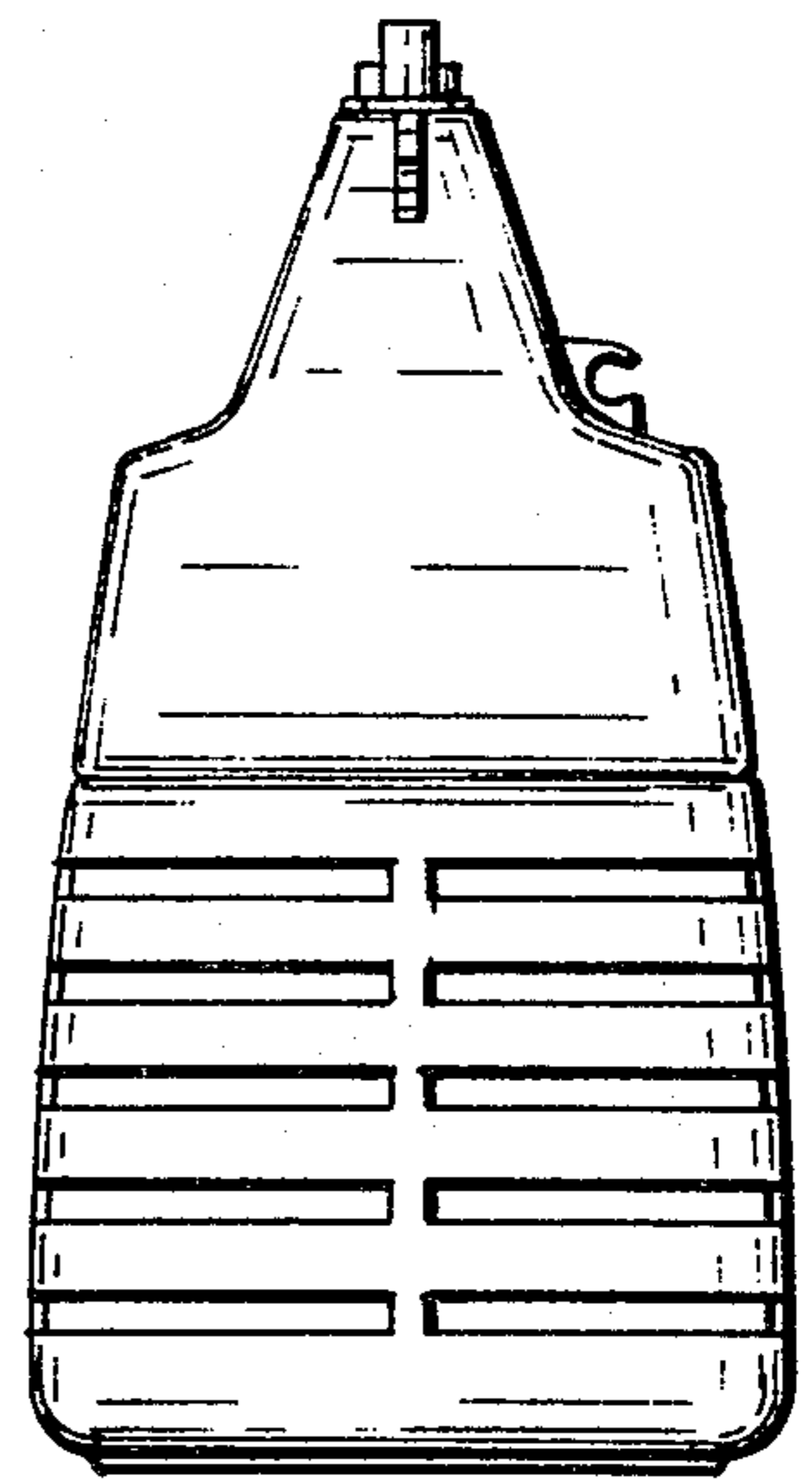

FIG 2

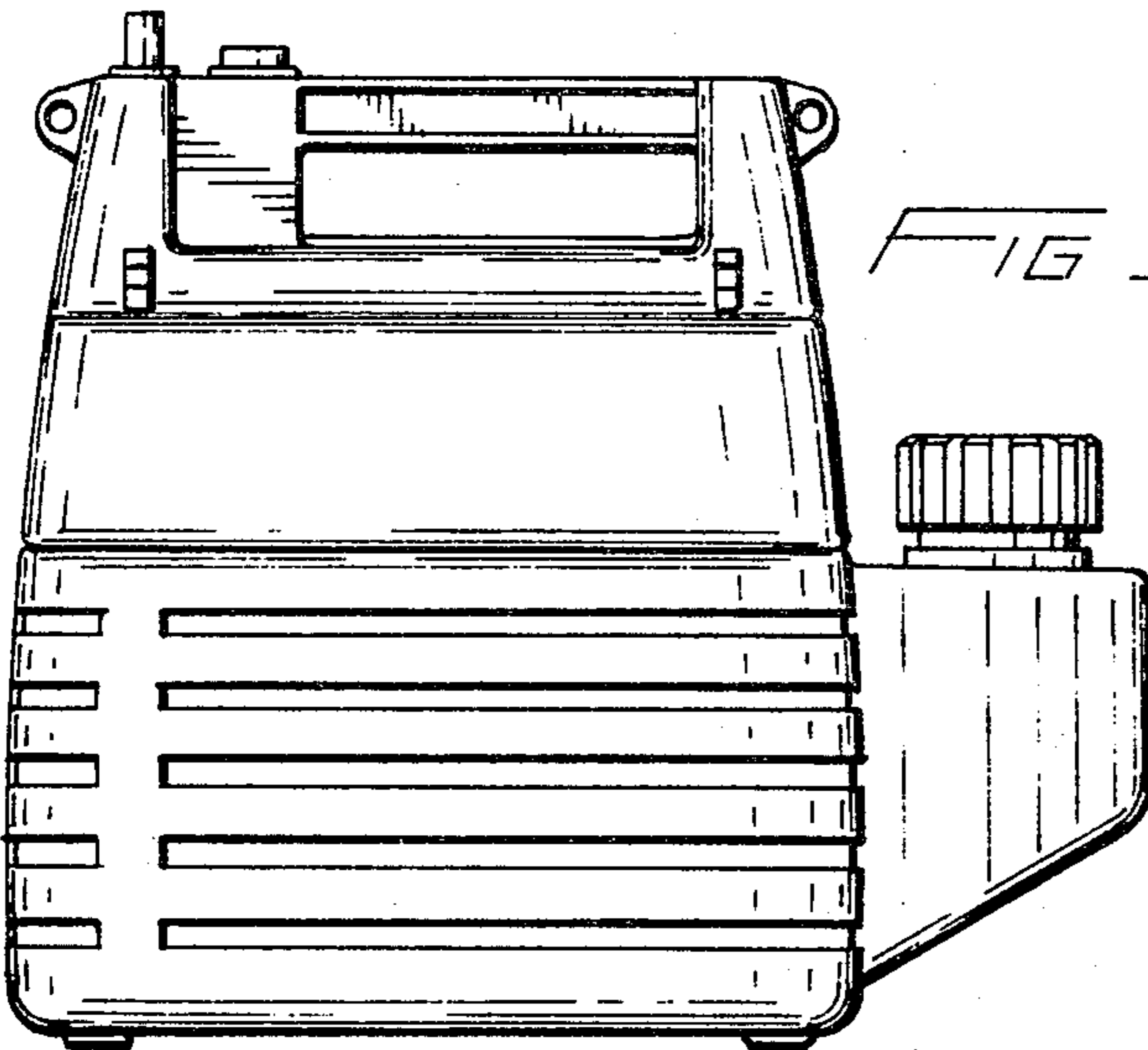

FIG 3

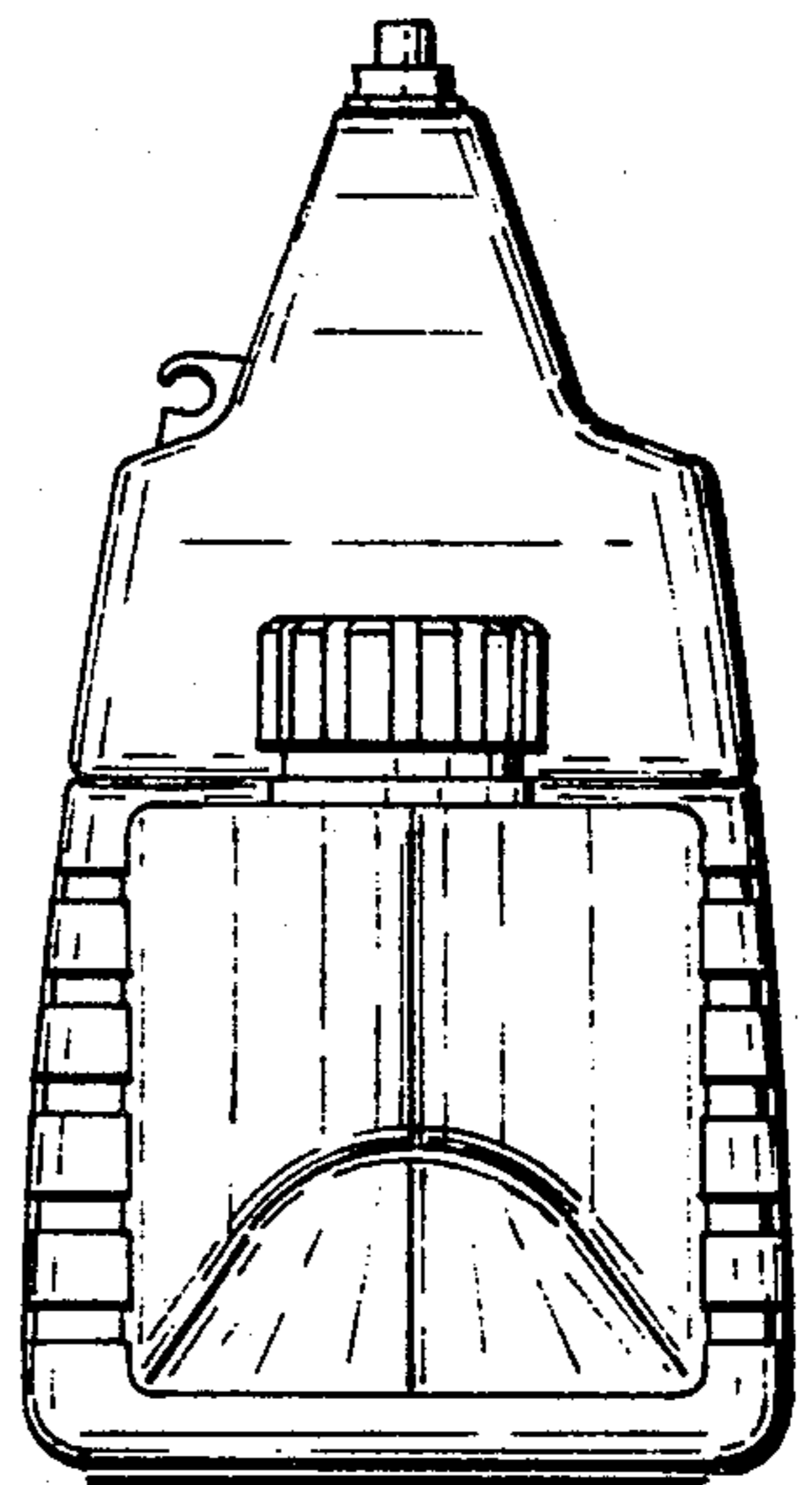

FIG 4

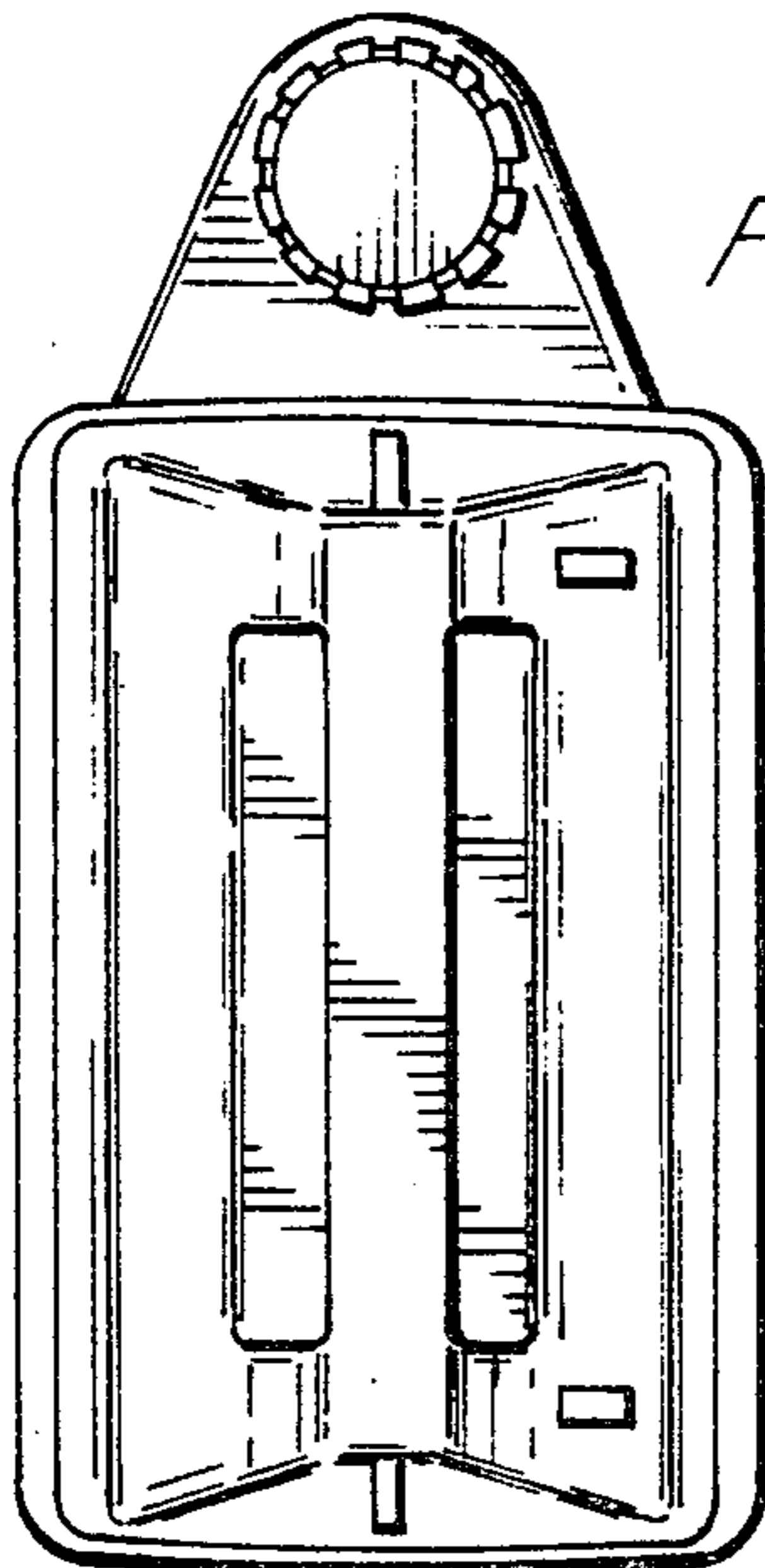

FIG 5

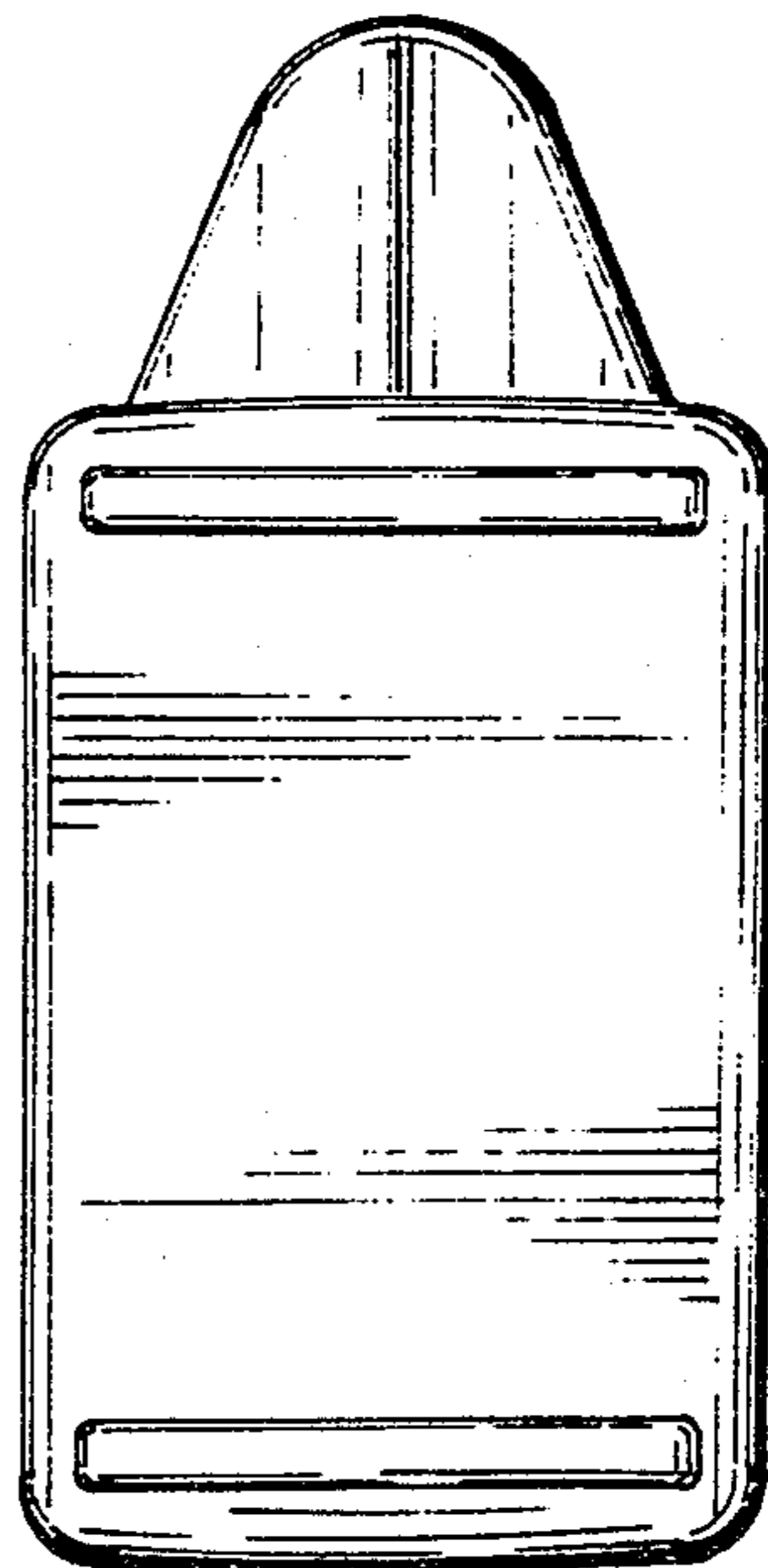

FIG 6

UNITED STATES PATENT AND TRADEMARK OFFICE
CERTIFICATE OF CORRECTION

PATENT NO. : Des. 284,885
DATED : Jul. 29, 1986
INVENTOR(S) : Kazuharu Nakamura

Page 1 of 2

It is certified that error appears in the above-identified patent and that said Letters Patent is hereby corrected as shown below:

Figs. 4 and 5 should appear as shown on the attached copy thereof.

**Signed and Sealed this
Third Day of March, 1987**

Attest:

Attesting Officer

DONALD J. QUIGG

Commissioner of Patents and Trademarks

Kazuharu Nakamura

FIG 4

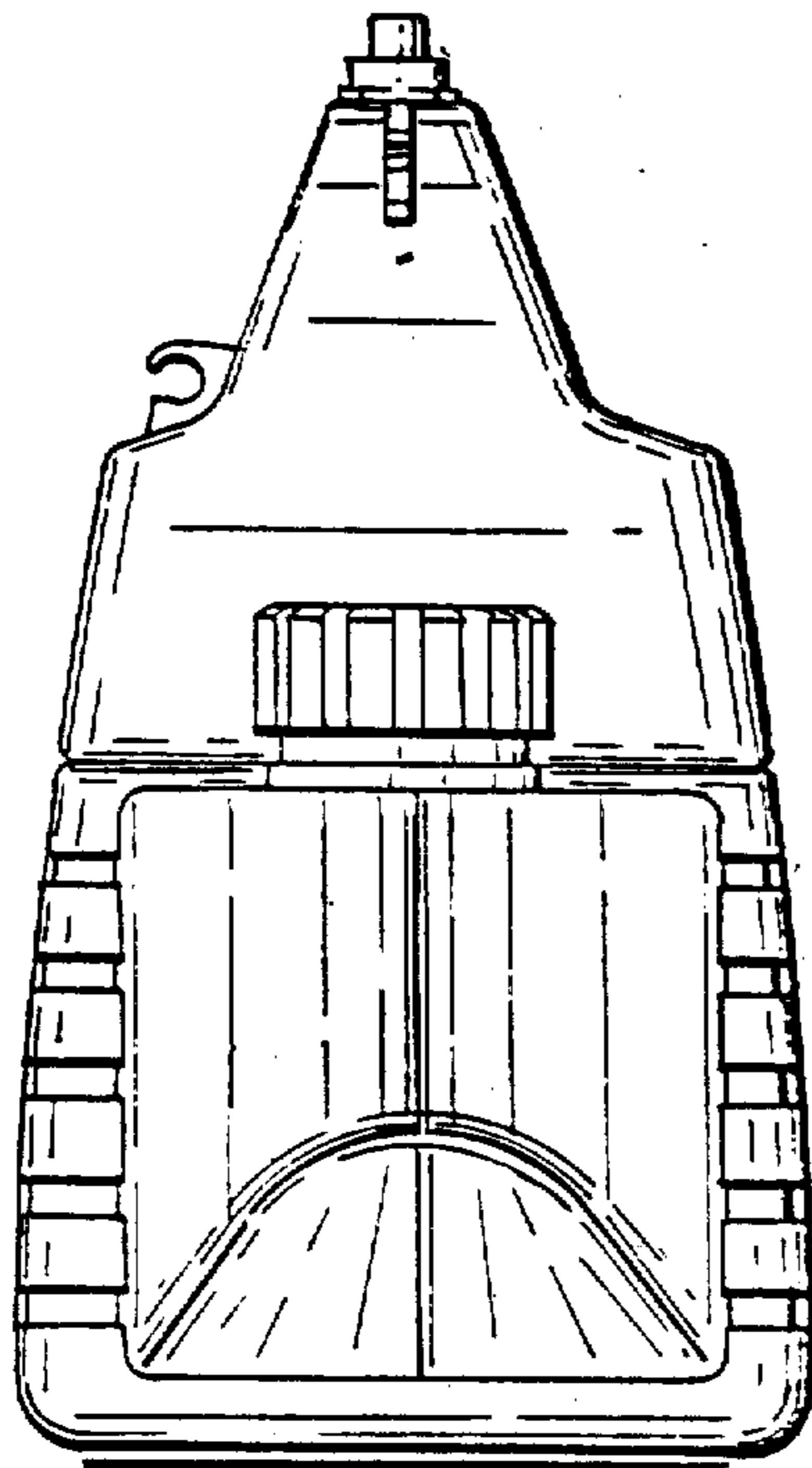

FIG 5

