

[54] **ROLLING TOY**

[76] **Inventor: Eugene R. Sengstacken, 31 Helena Ave., Bethpage, N.Y. 11714**

[**] **Term: 14 Years**

[21] **Appl. No.: 631,478**

[22] **Filed: Jul. 16, 1984**

[52] **U.S. Cl. D21/59; D21/124**

[58] **Field of Search D8/383; D21/227, 128, D21/124, 132, 134, 135, 137, 59; 446/439, 448, 450, 451, 452, 454, 456, 465, 469, 470**

[56] **References Cited**

U.S. PATENT DOCUMENTS

2,651,882 9/1953 Core 446/451
2,773,709 12/1956 Smith D8/383

OTHER PUBLICATIONS

Lionel Train Christmas Catalog, 1938, p. 26, Toy Train Wheels With Axle.

Primary Examiner—Charles A. Rademaker
Attorney, Agent, or Firm—Michael I. Kroll

[57] **CLAIM**

The ornamental design for a rolling toy, as shown.

DESCRIPTION

FIG. 1 is a top plan view of a rolling toy showing my new design;
FIG. 2 is a side elevational view thereof;
FIG. 3 is a front elevational view thereof;
FIG. 4 is a side elevational view thereof;
FIG. 5 is a bottom plan view thereof; and,
FIG. 6 is a rear elevational view thereof.

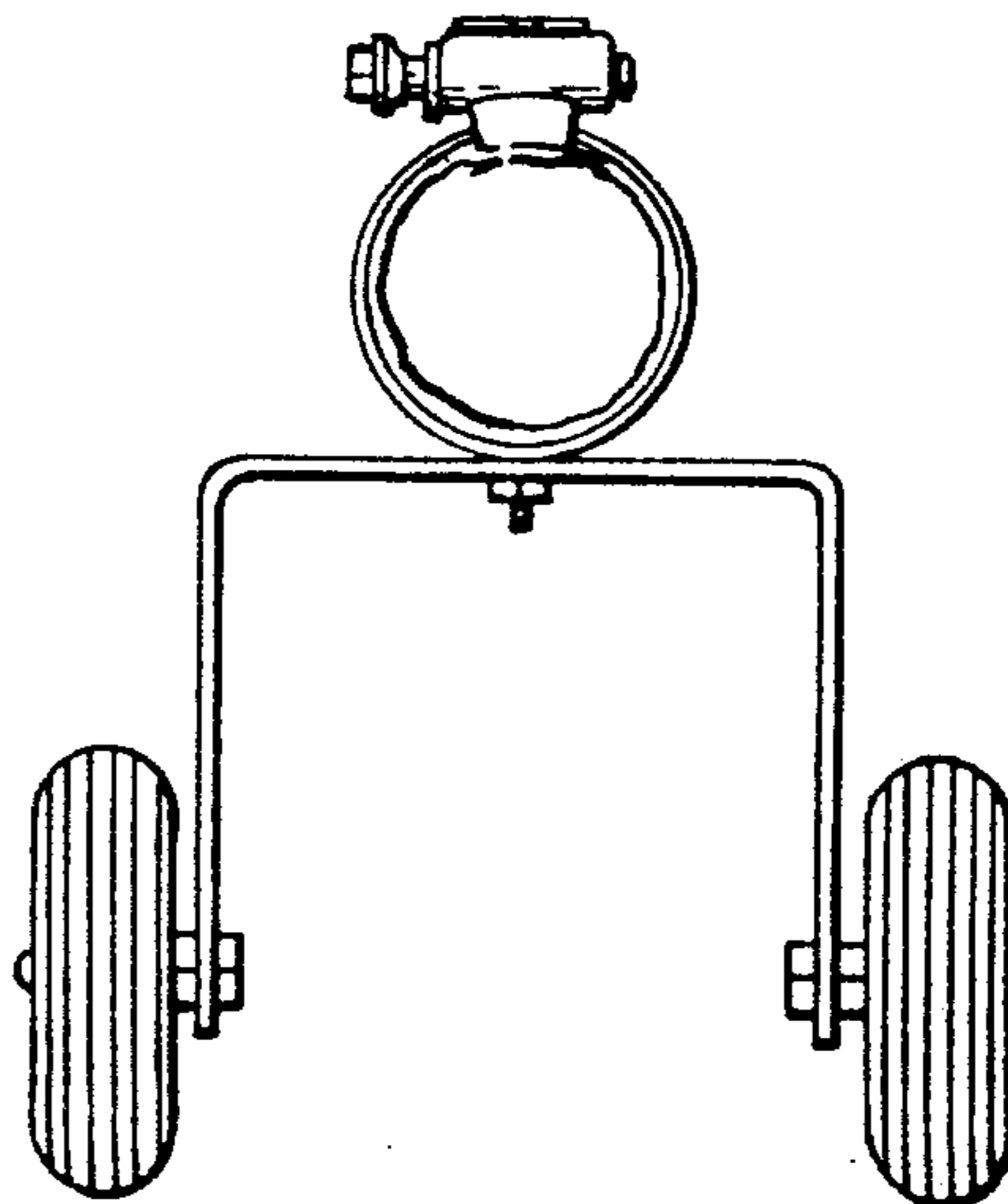

Figure 1

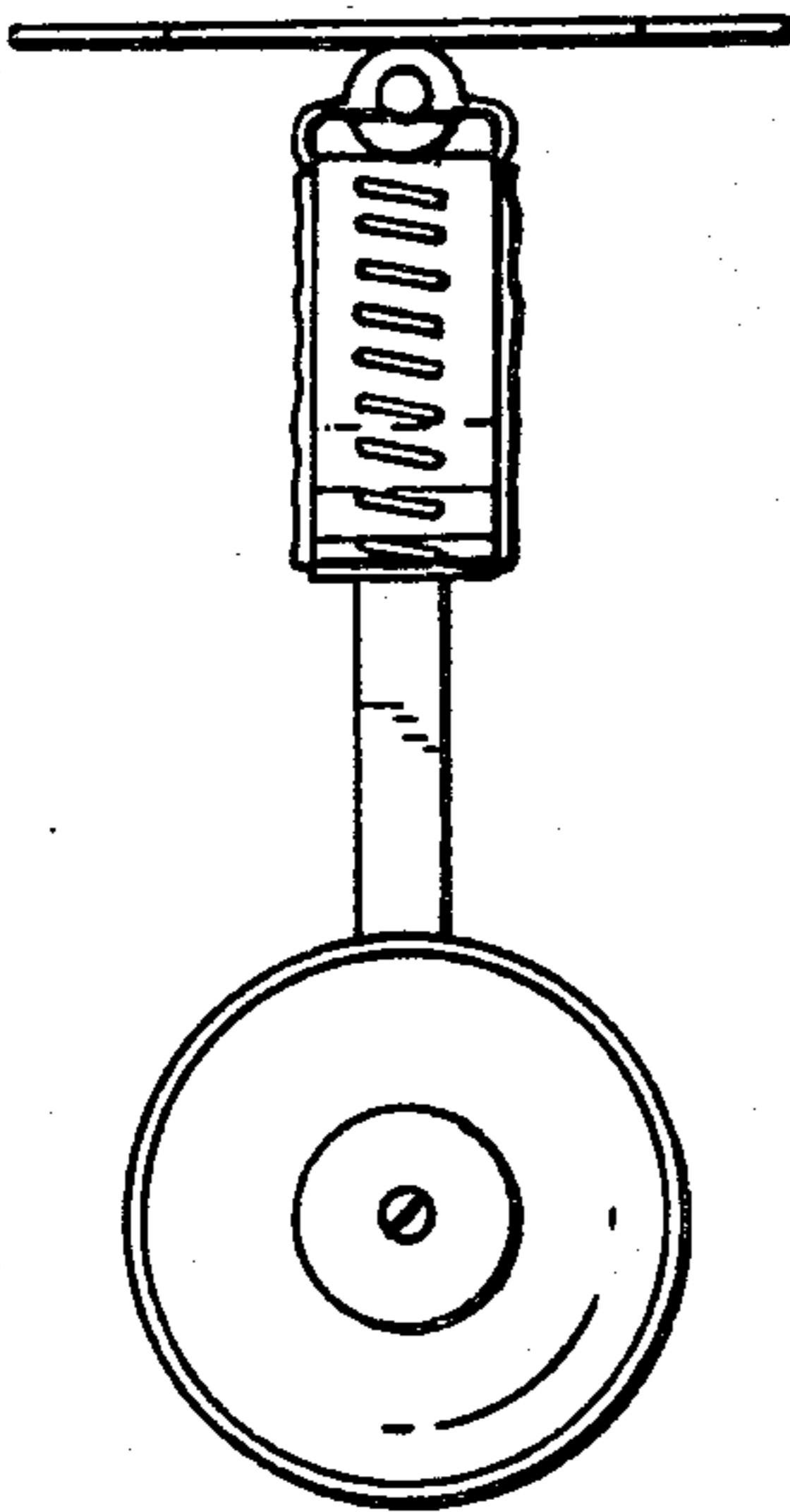
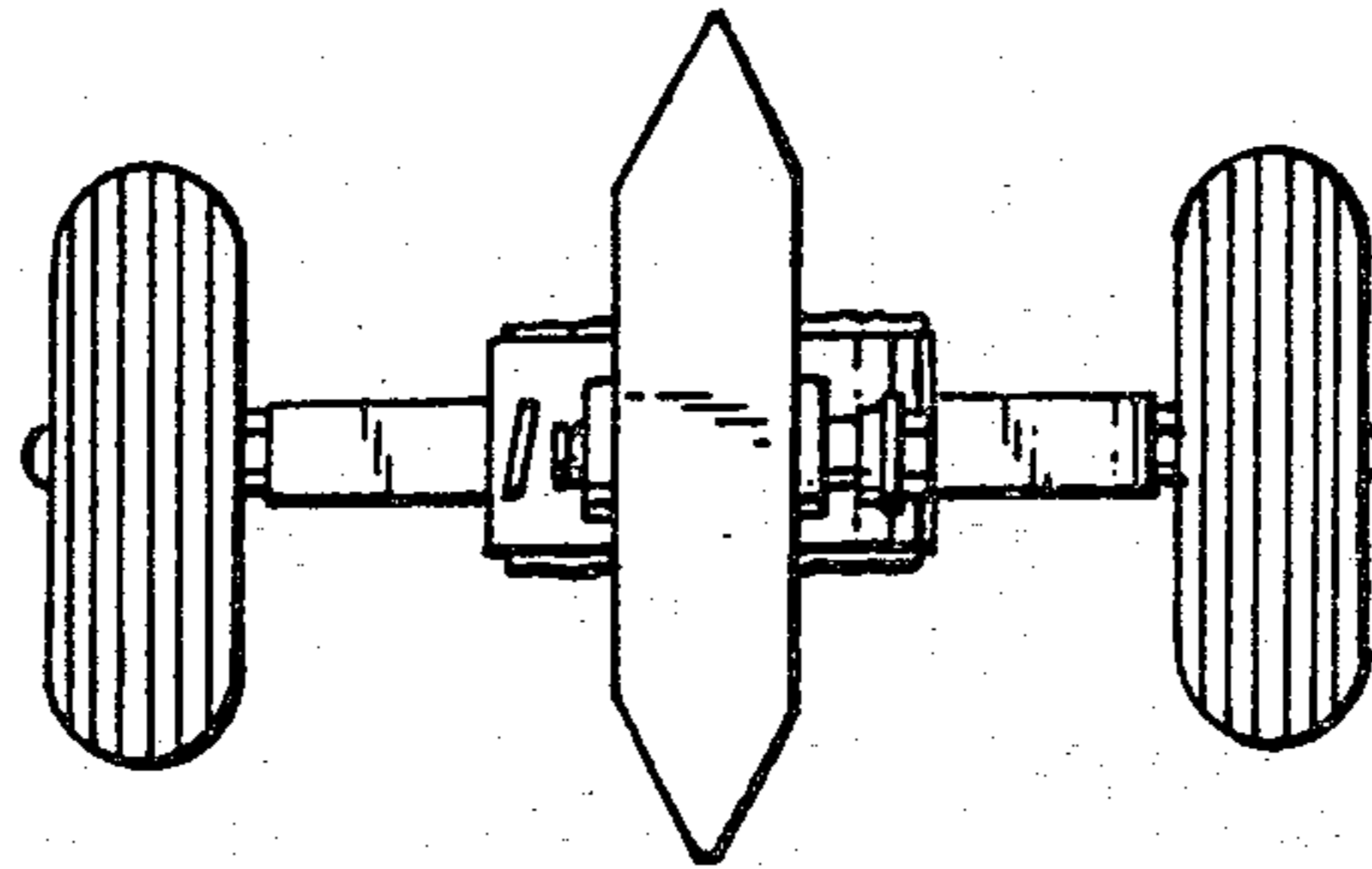

Figure 2

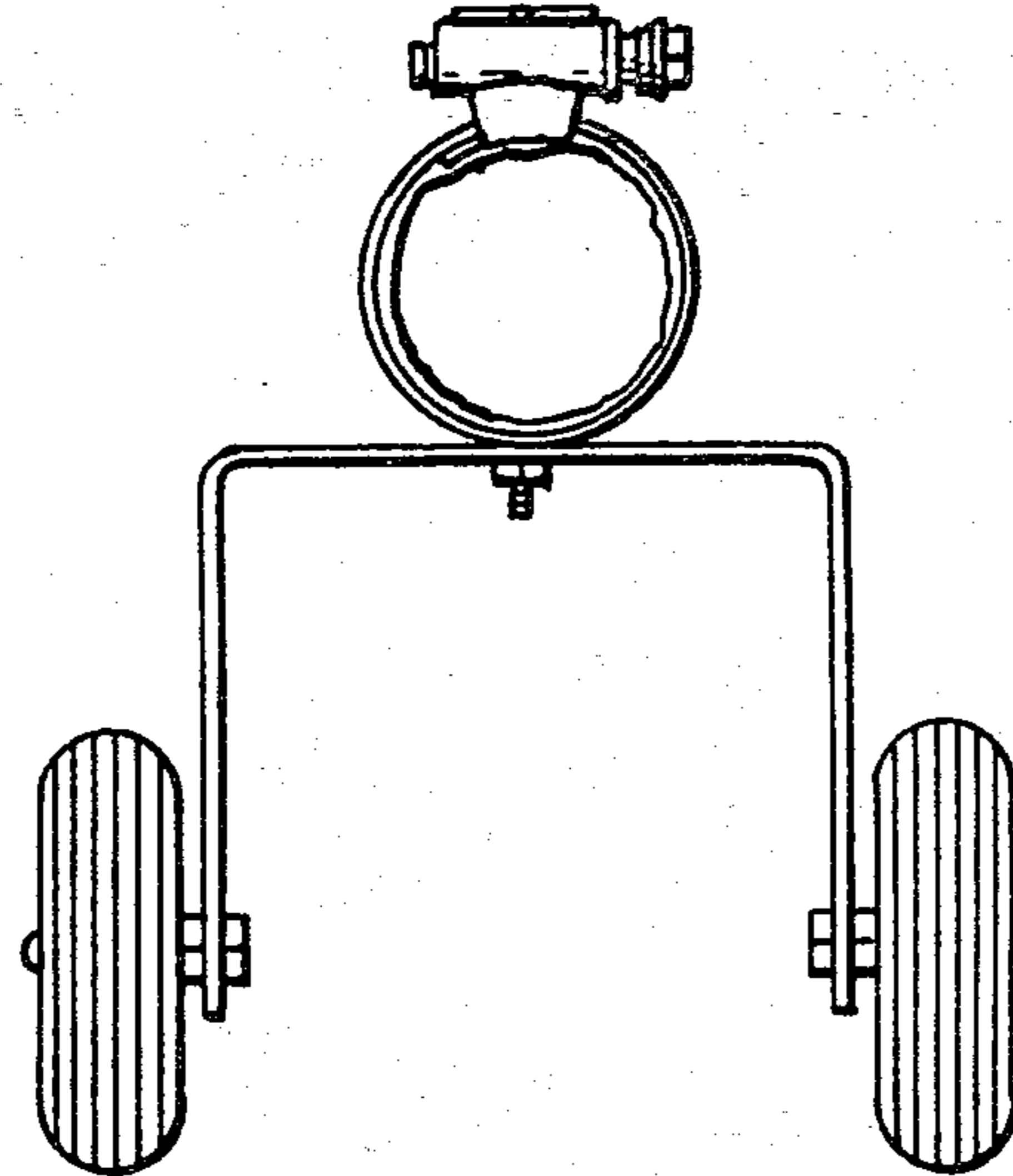

Figure 3

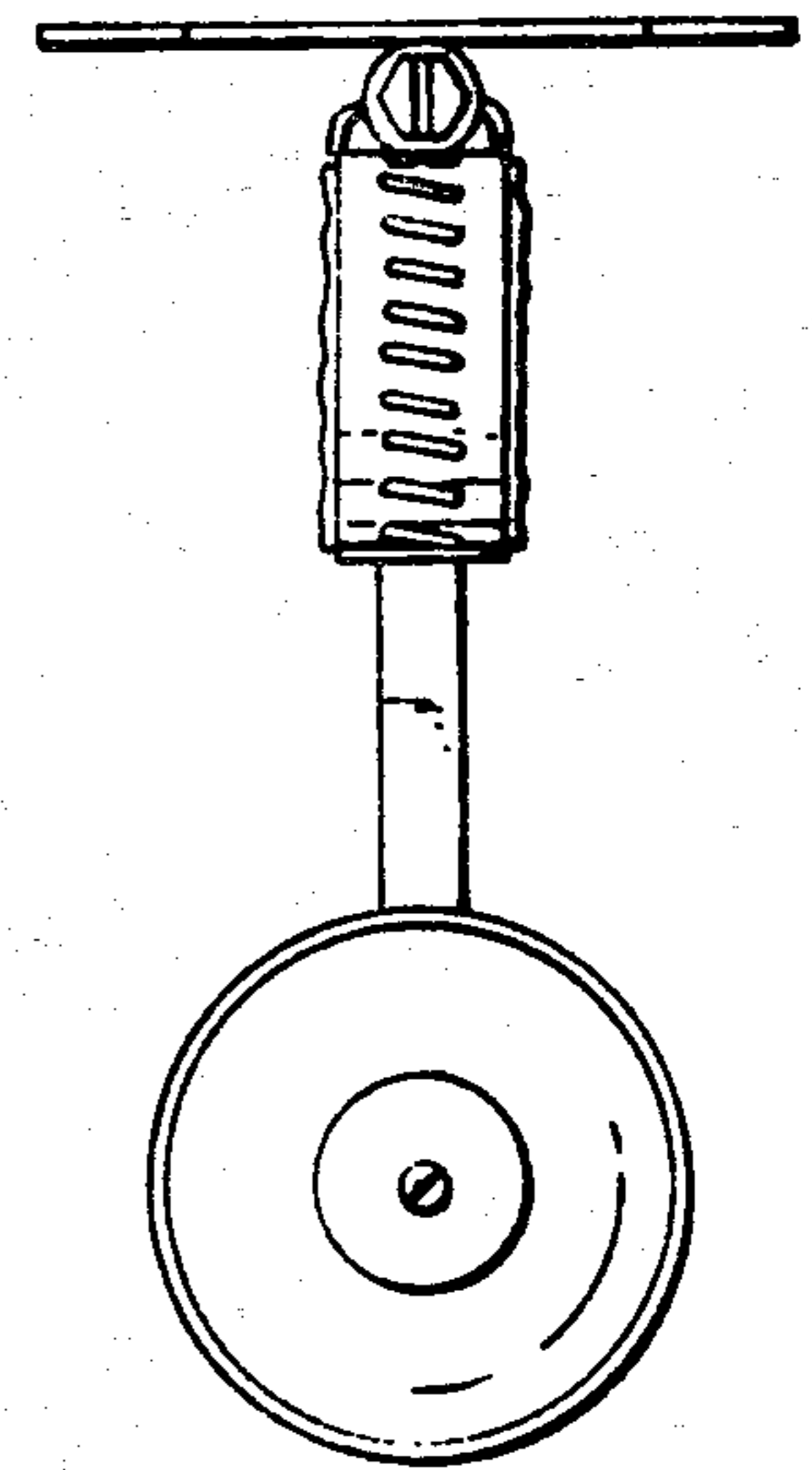

Figure 4

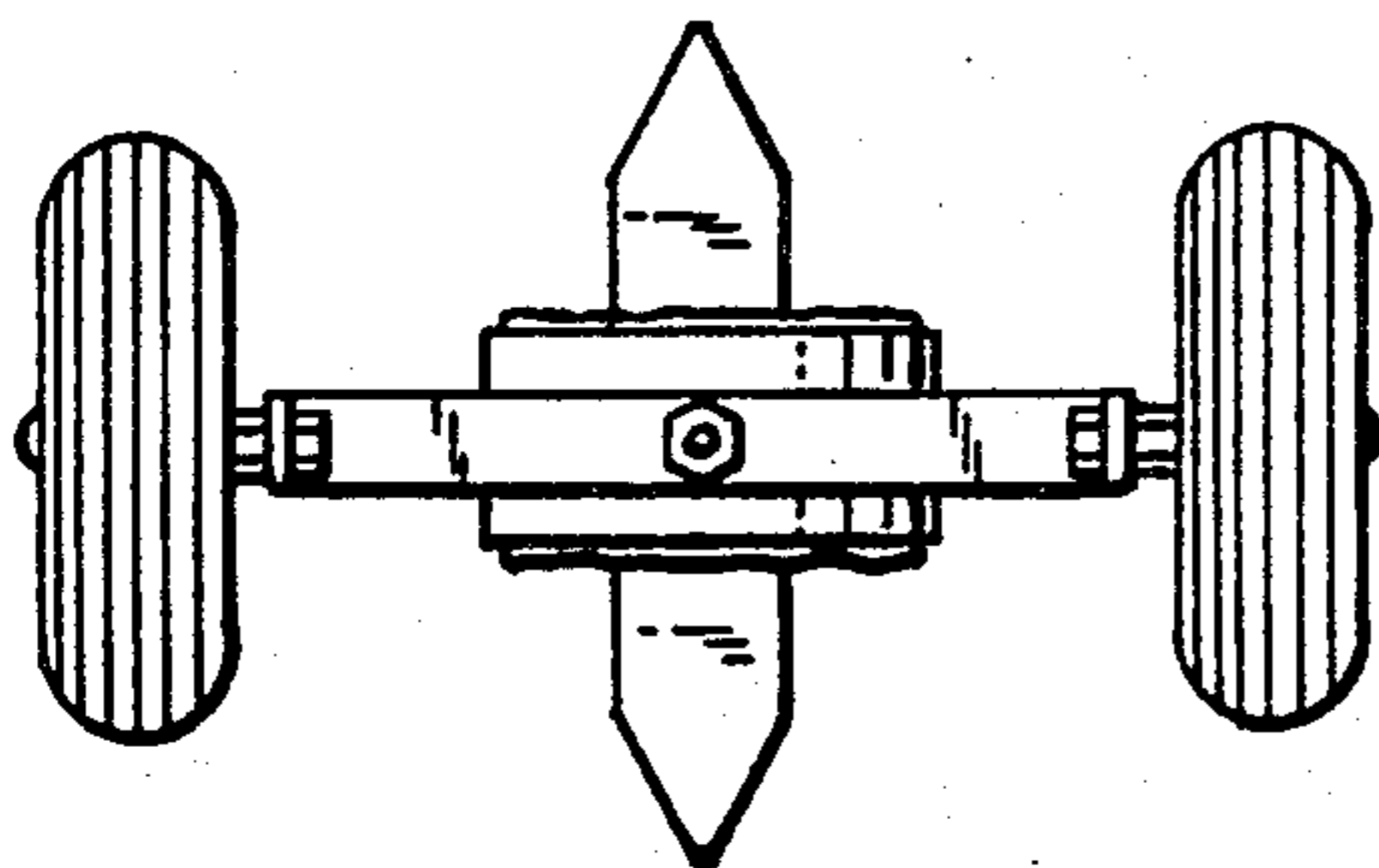

Figure 5

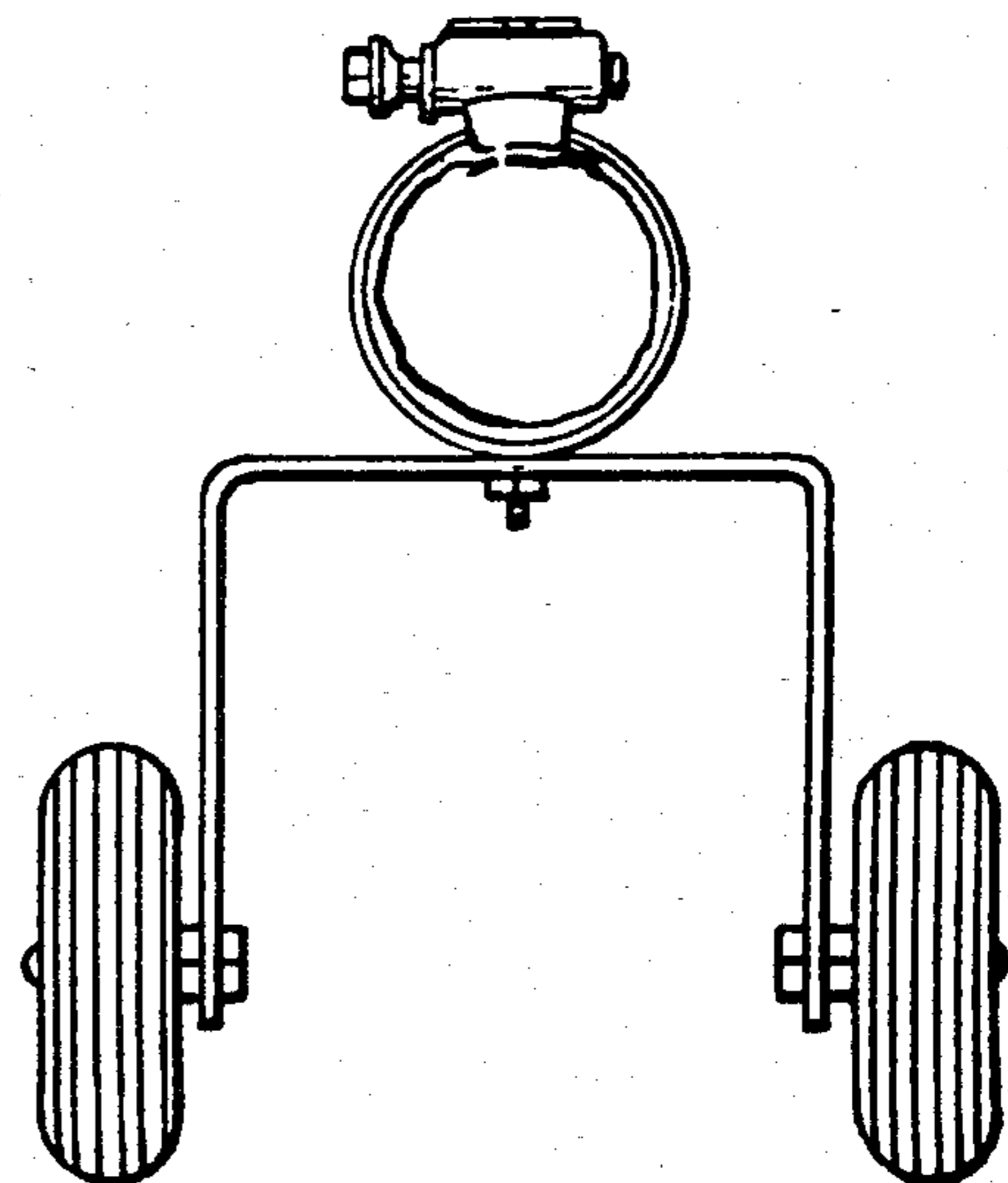

Figure 6