

[54] GOBLET OR SIMILAR ARTICLE

[75] Inventor: David H. Inns, Retford, England
[73] Assignee: Glass Bulbs Limited, Chesterfield, England
[**] Term: 14 Years
[21] Appl. No.: 535,782
[22] Filed: Sep. 26, 1983

[30] Foreign Application Priority Data

May 12, 1983 [GB] United Kingdom 1012992
[52] U.S. Cl. D7/13
[58] Field of Search D7/11, 12, 13, 6, 14, D7/15, 22; D9/429

[56] References Cited

U.S. PATENT DOCUMENTS

D. 98,909	3/1936	Bell	D7/13
D. 104,703	5/1937	Sakier	D7/13
D. 107,739	1/1938	Bell	D7/13
D. 108,003	1/1938	Kelly	D7/13
D. 109,675	5/1938	Saunders	D7/14
D. 122,766	10/1940	Carlson	D7/13
D. 236,405	8/1975	Thrush	D7/13

OTHER PUBLICATIONS

Libbey Glassware for the Food Service Industry, Catalog, pp. 8, 9, "Embassy Stemware", All Rounded Goblet Bowls.

Primary Examiner—Winifred E. Herrmann
Attorney, Agent, or Firm—Fleit, Jacobson, Cohn & Price

[57] CLAIM

The ornamental design for a goblet or similar article, as shown and described.

DESCRIPTION

FIG. 1 is a side elevational view of a goblet or similar article showing my new design in the size and proportions of an old-fashioned goblet;
FIG. 2 is a top view thereof;
FIG. 3 is a sectional view on an enlarged scale taken along line 3—3 of FIG. 1;
FIG. 4 is a side elevational view of a goblet or similar article showing my new design in the size and proportions of a champagne goblet;
FIG. 5 is a top view thereof;
FIG. 6 is a sectional view on an enlarged scale taken along line 6—6 of FIG. 4;
FIG. 7 is a side elevational view of a goblet or similar article showing my new design in the size and proportions of a wine goblet;
FIG. 8 is a top view thereof;
FIG. 9 is a sectional view on an enlarged scale taken along line 9—9 of FIG. 6;
FIG. 10 is a side elevational view of a goblet or similar article showing my new design in the size and proportions of a snifter;
FIG. 11 is a top view thereof;
FIG. 12 is a sectional view on an enlarged scale taken along line 12—12 of FIG. 10;
FIG. 13 is a side elevational view of a goblet or similar article showing my new design in the size and proportions of a water goblet;
FIG. 14 is a top view thereof; and
FIG. 15 is a sectional view on an enlarged scale taken along line 15—15 of FIG. 13.

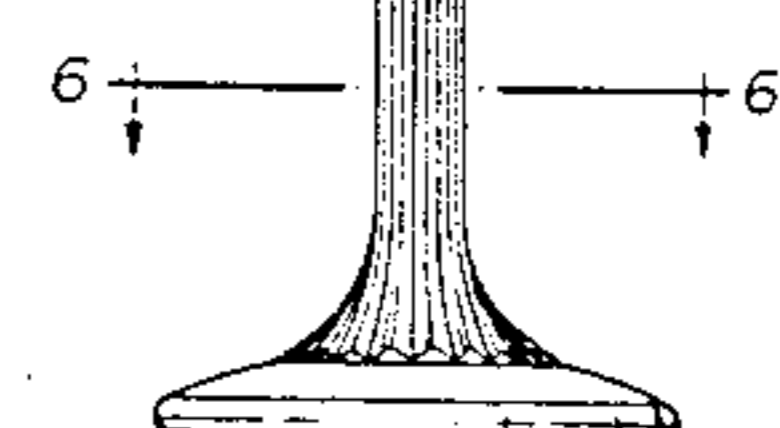
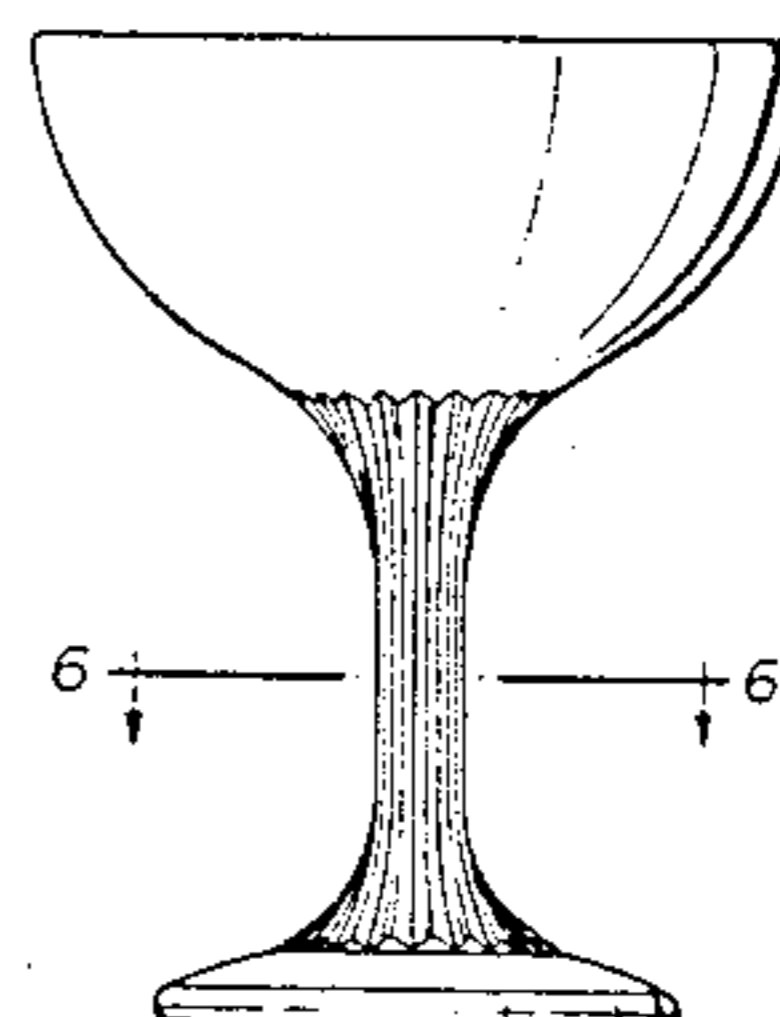
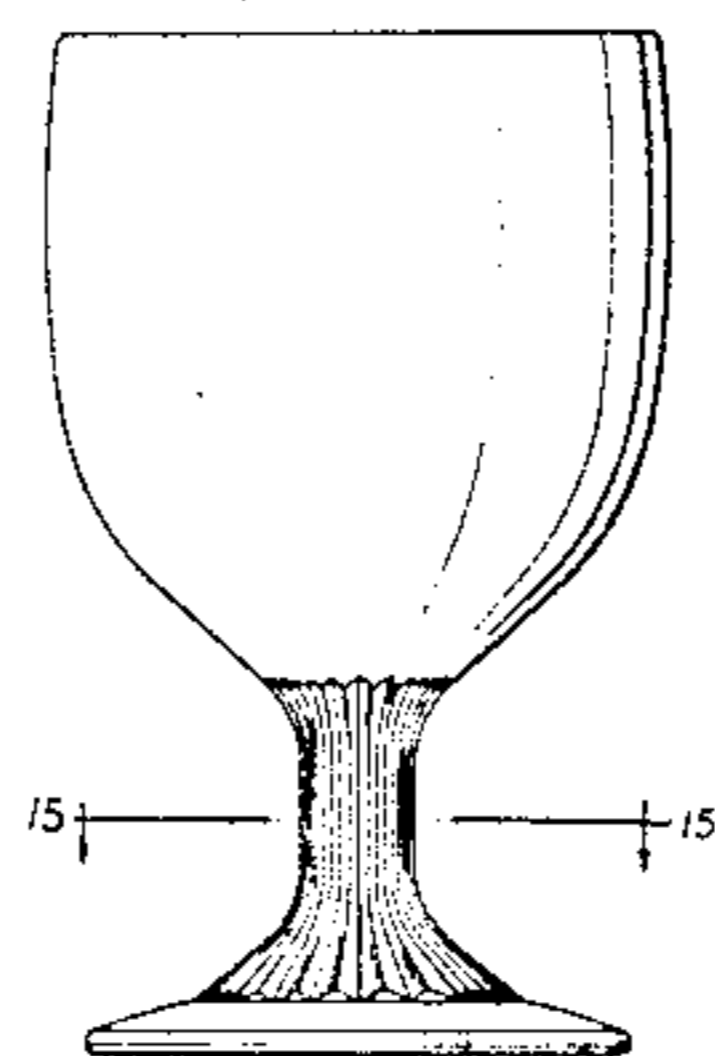
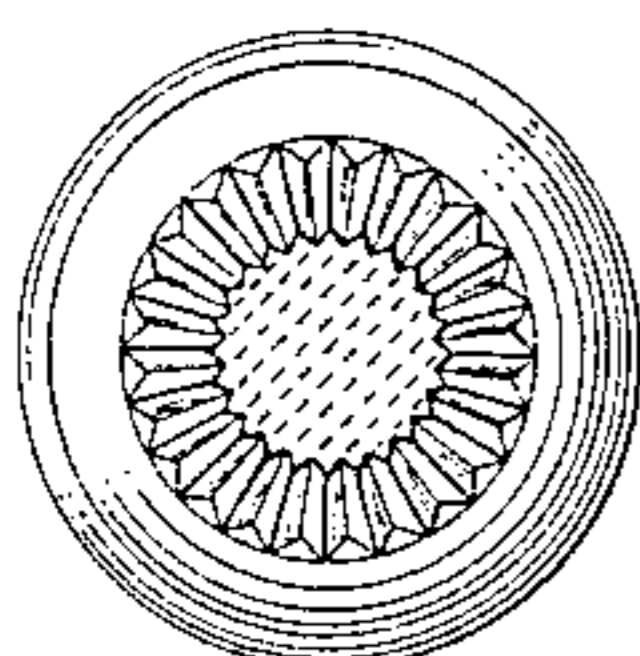
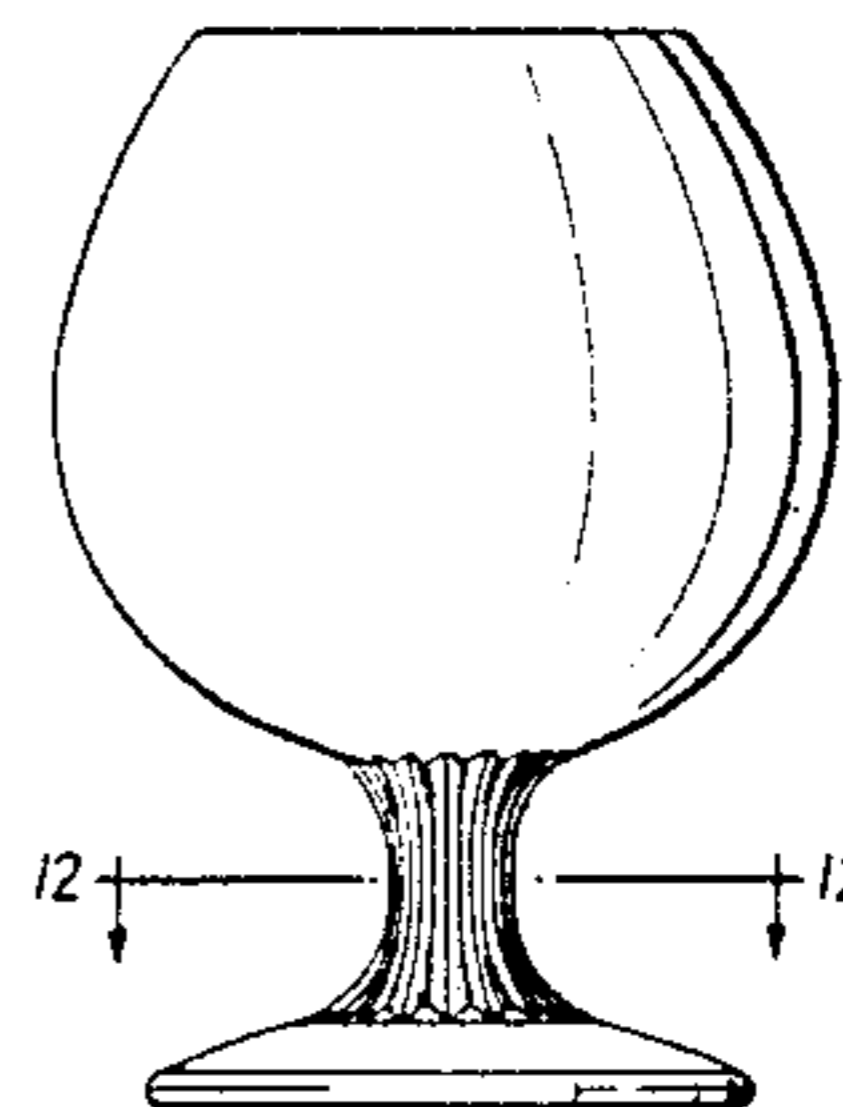
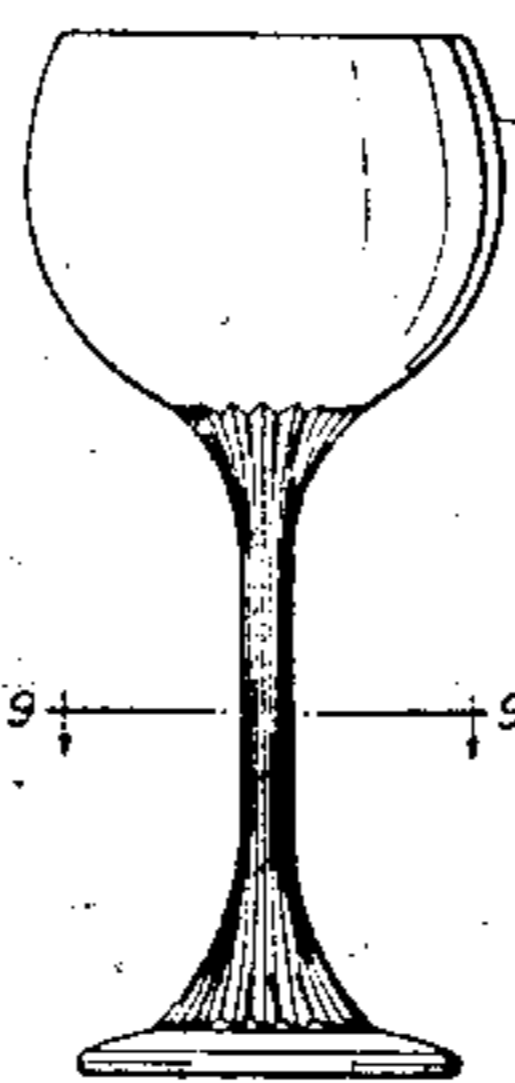
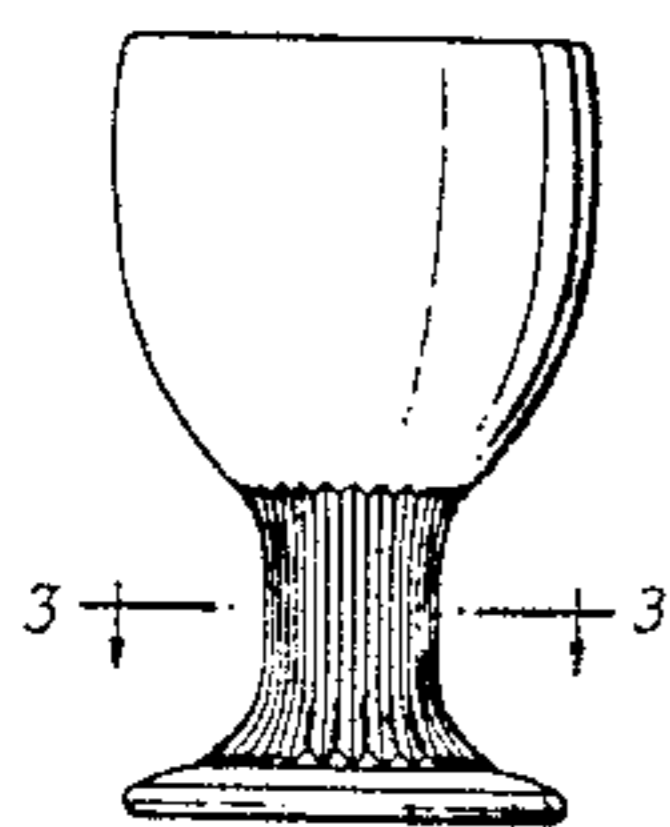

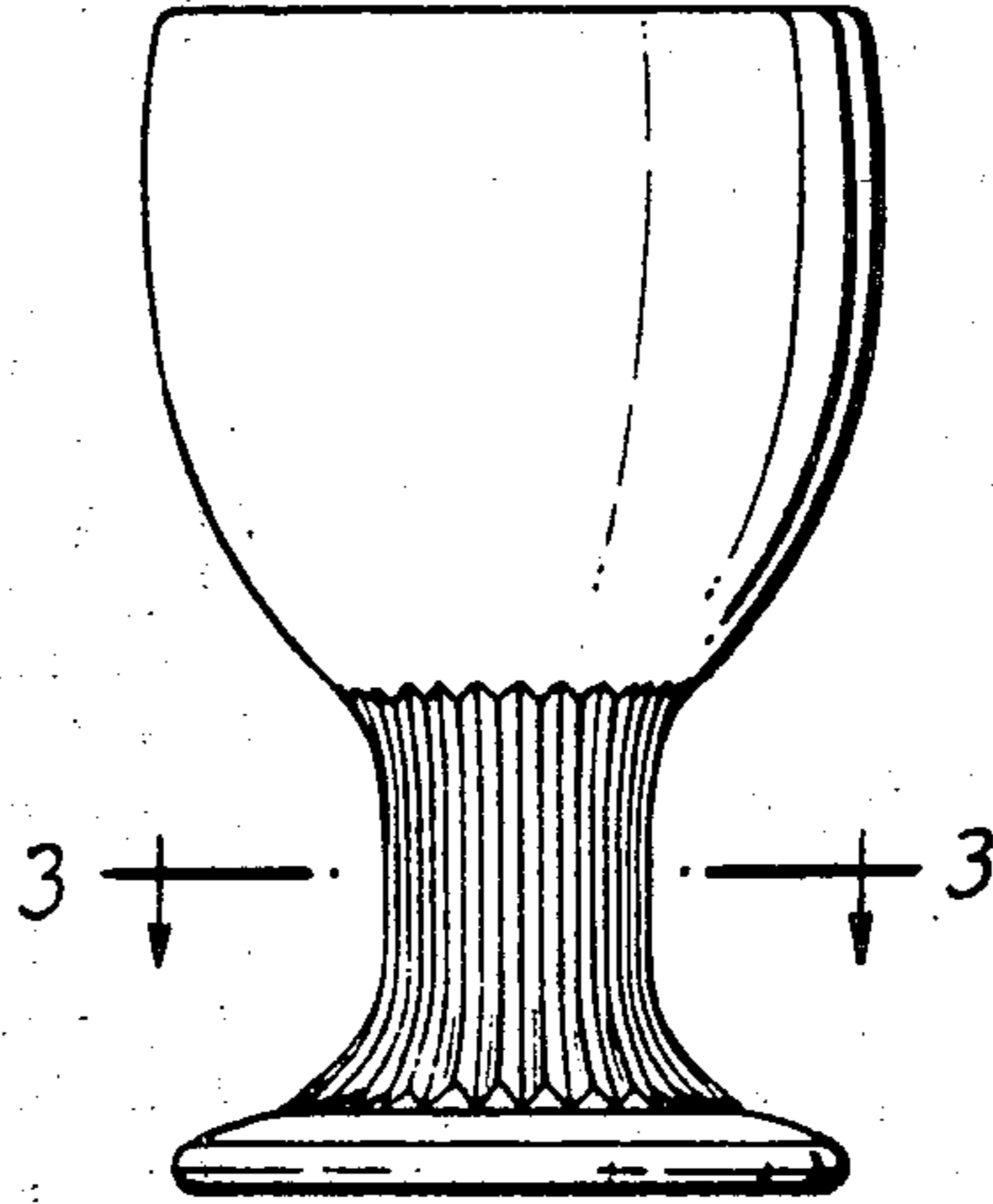

FIG. 1

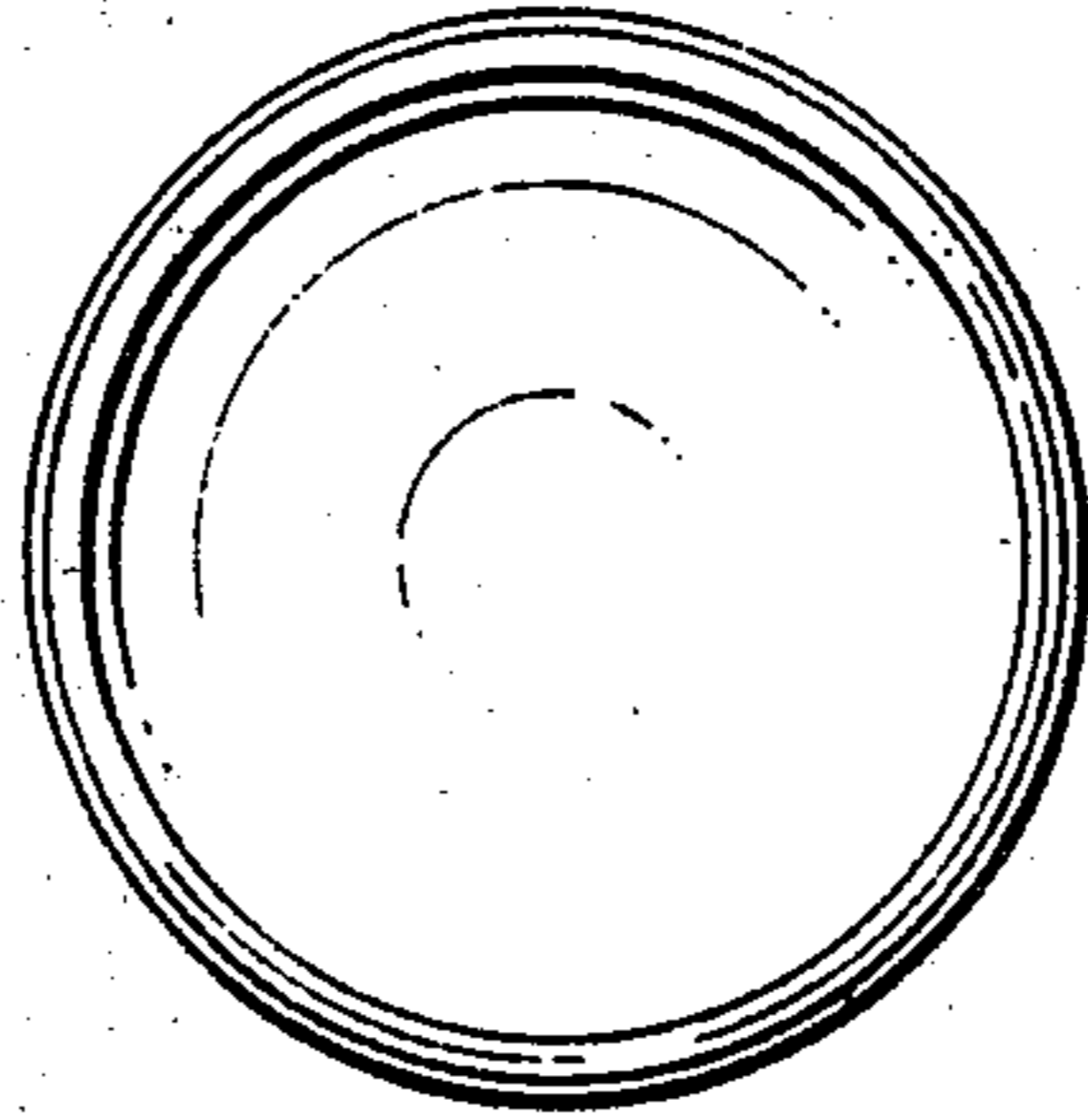

FIG. 2

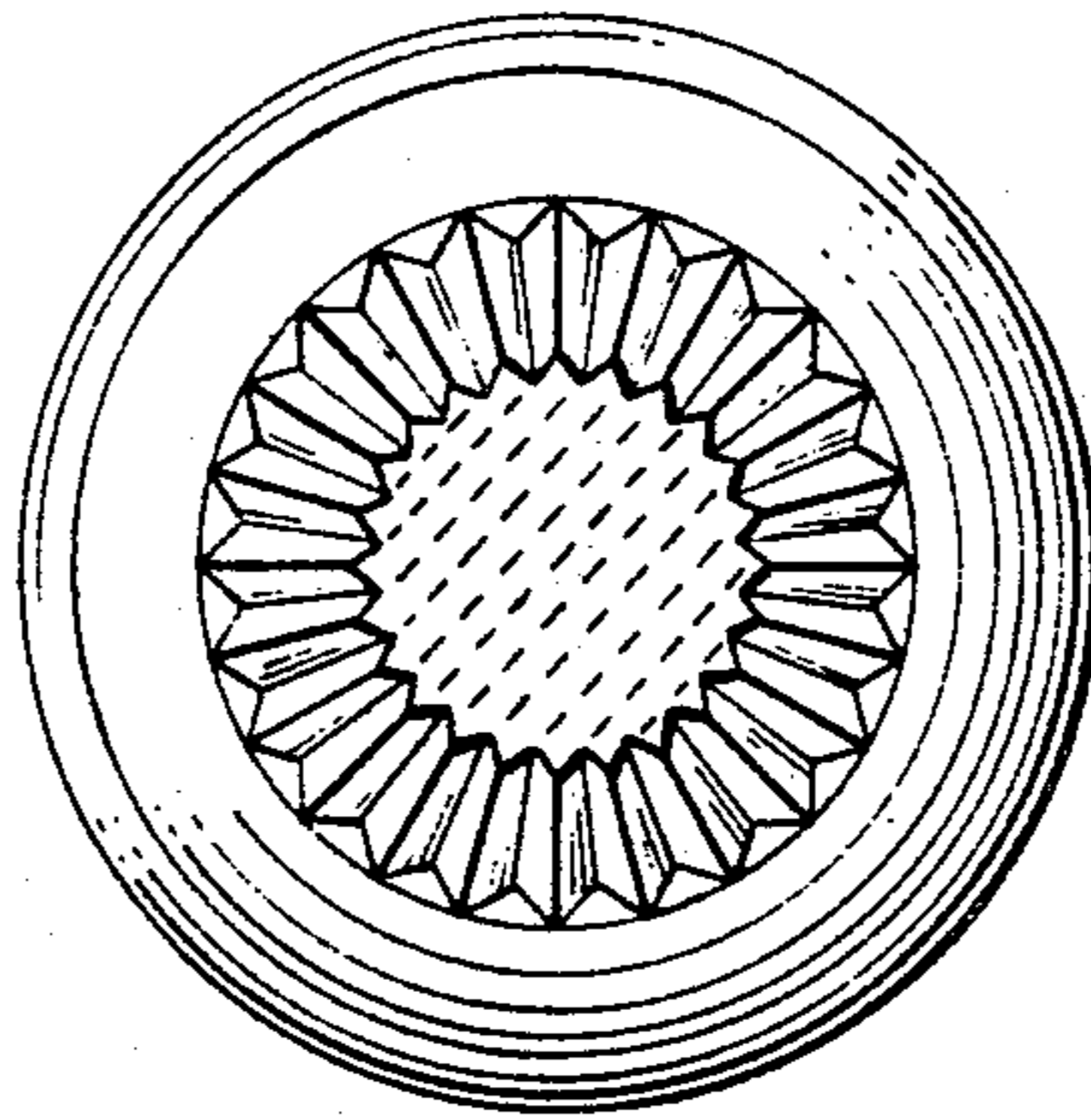

FIG. 3

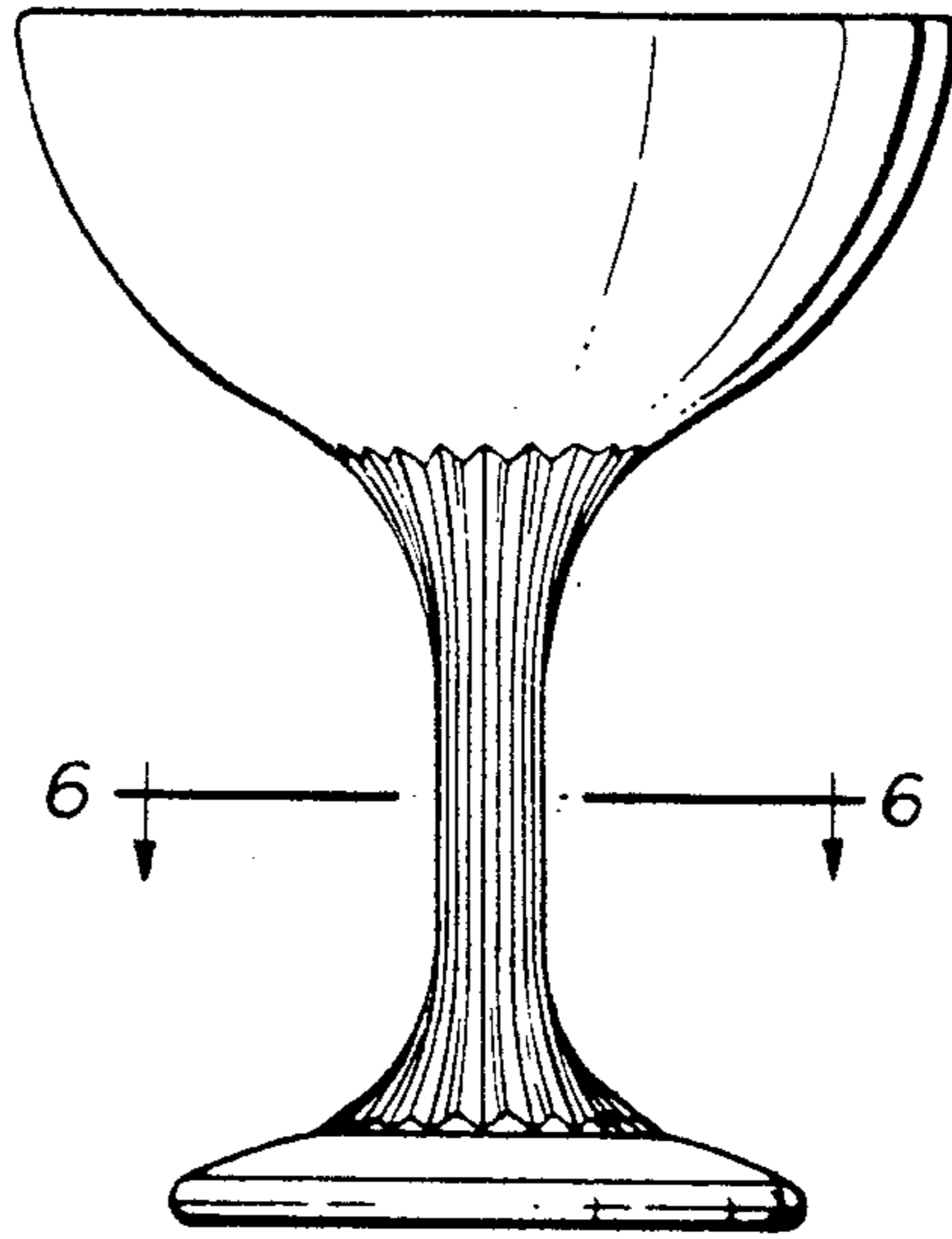

FIG. 4

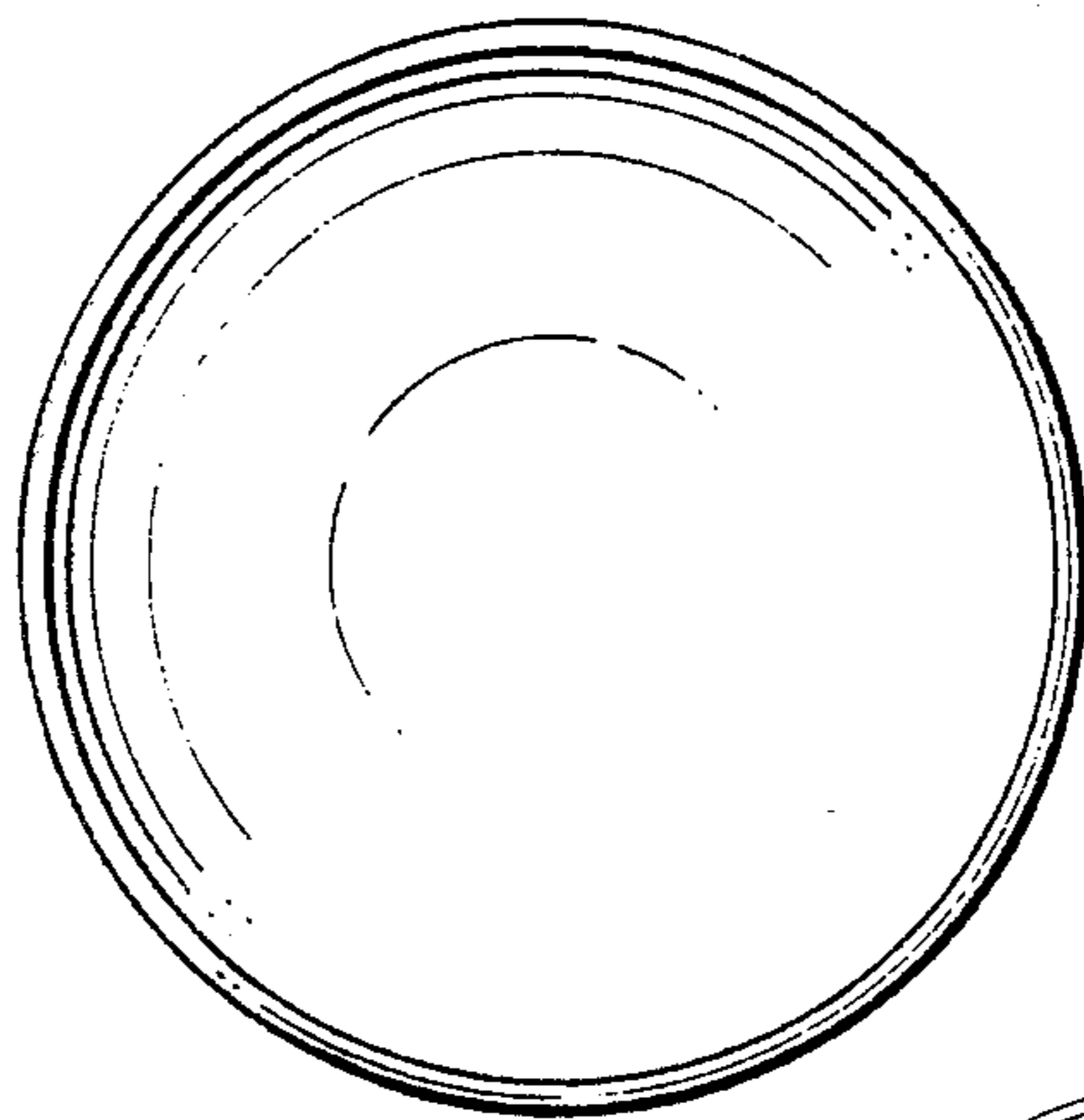

FIG. 5

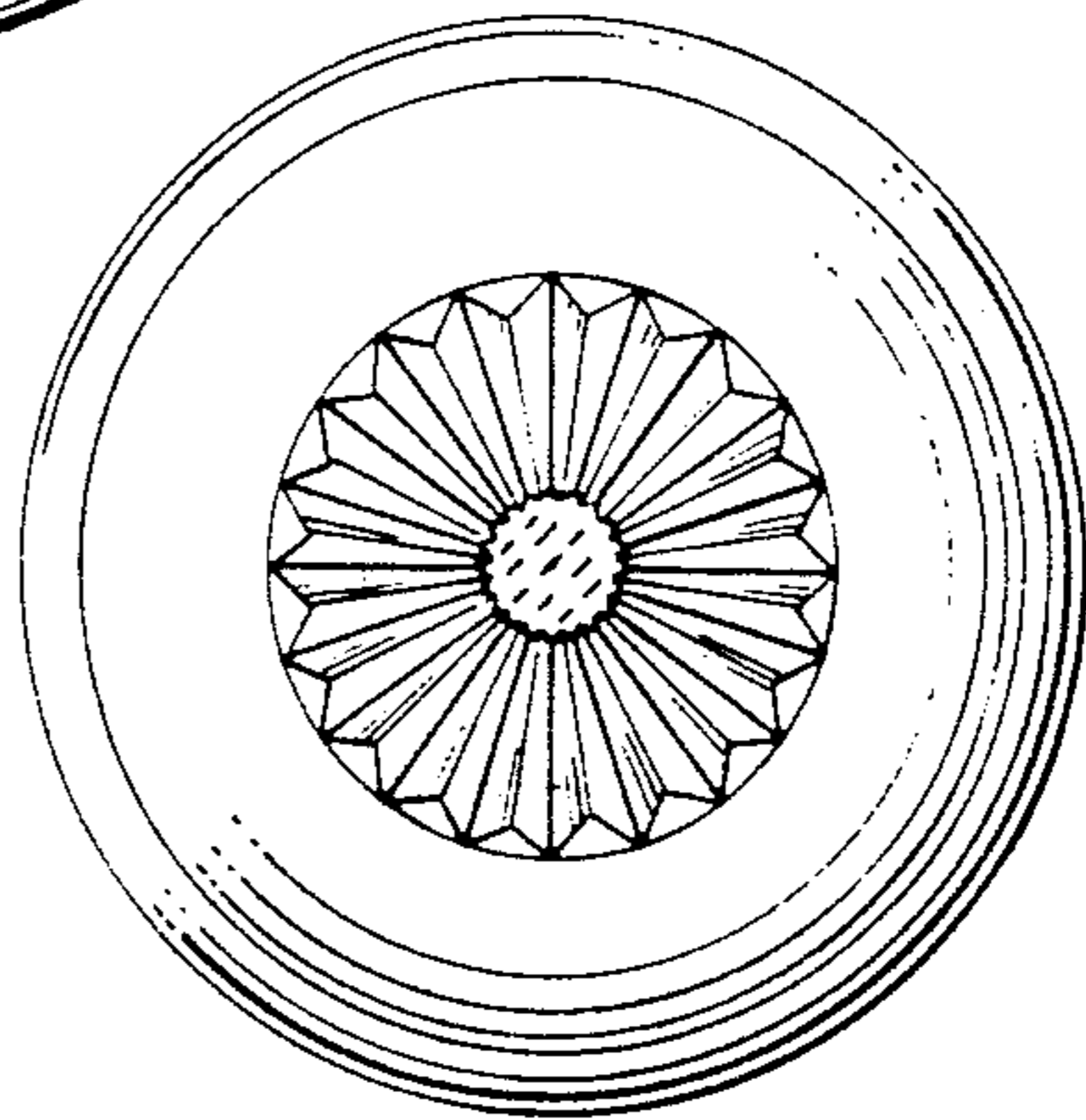

FIG. 6

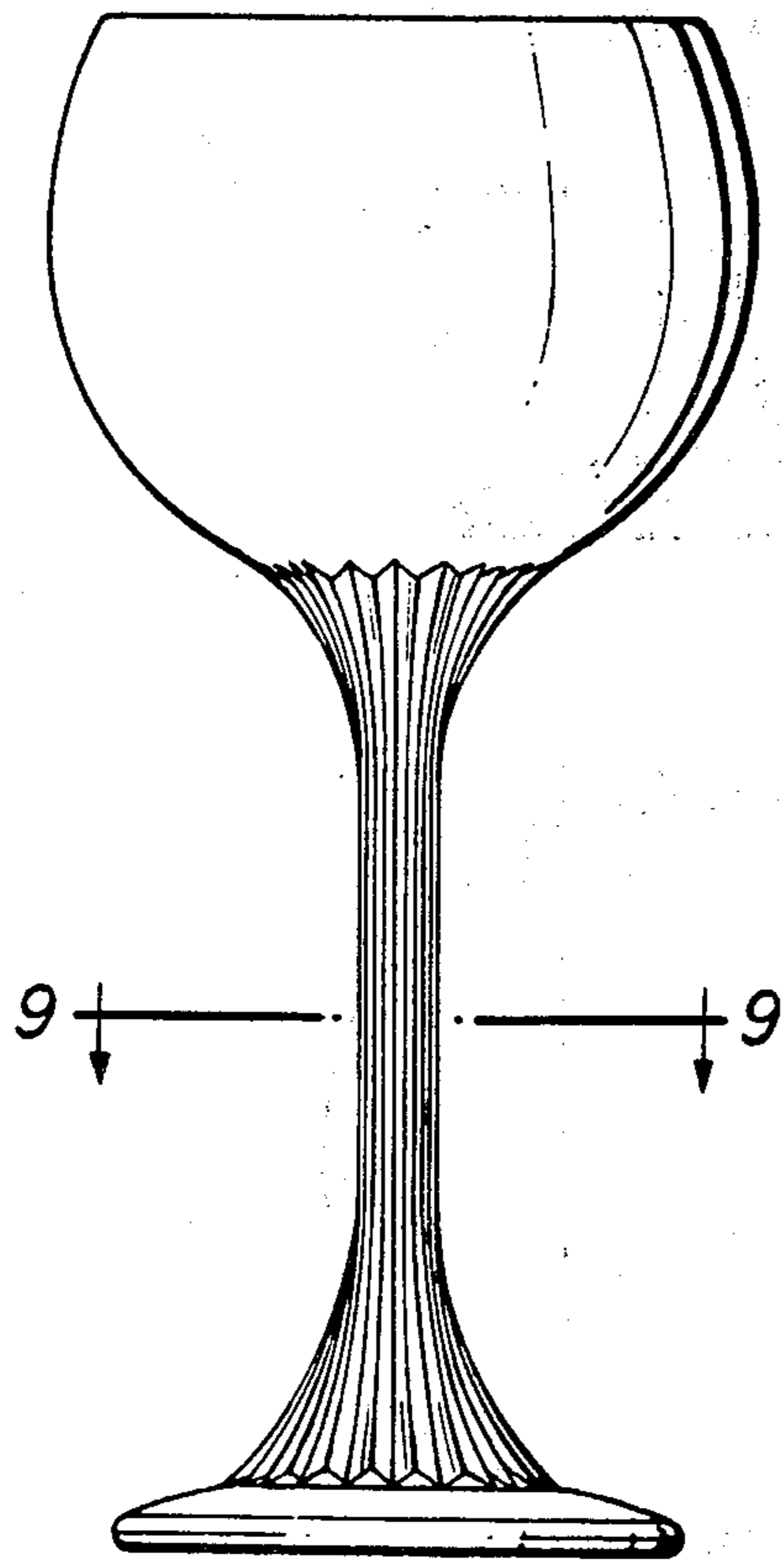

FIG. 7

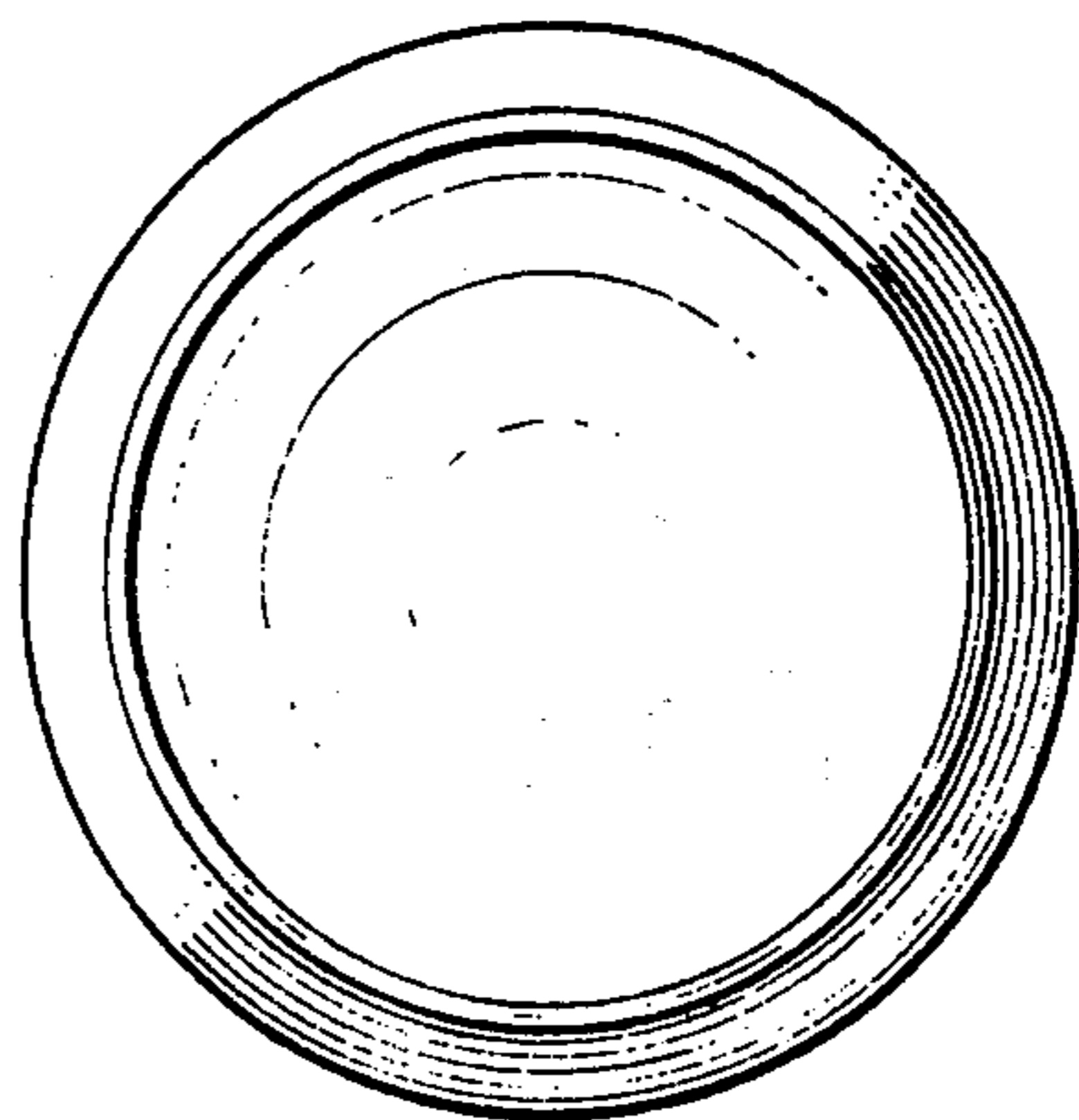

FIG. 8

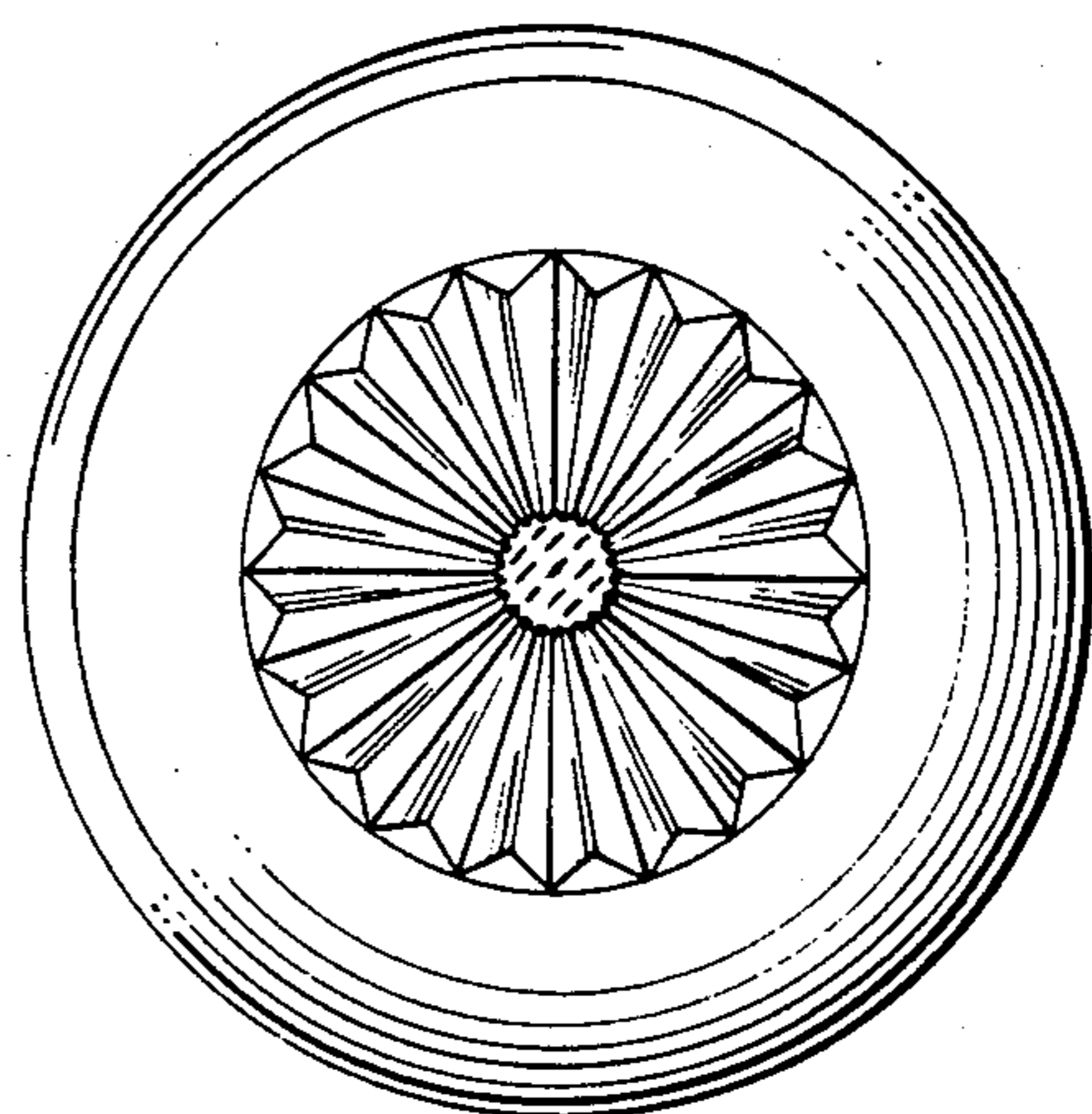

FIG. 9

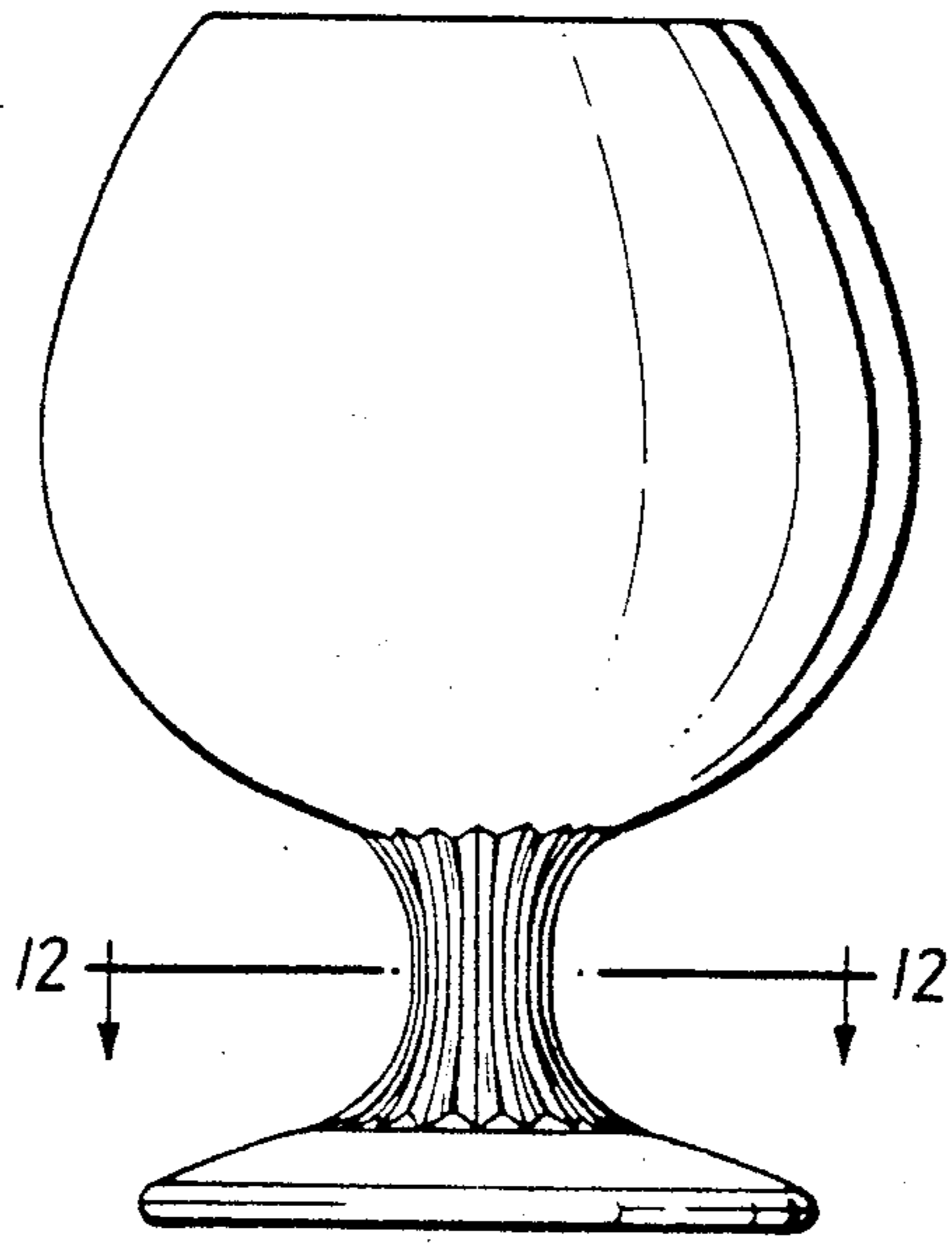

FIG. 10

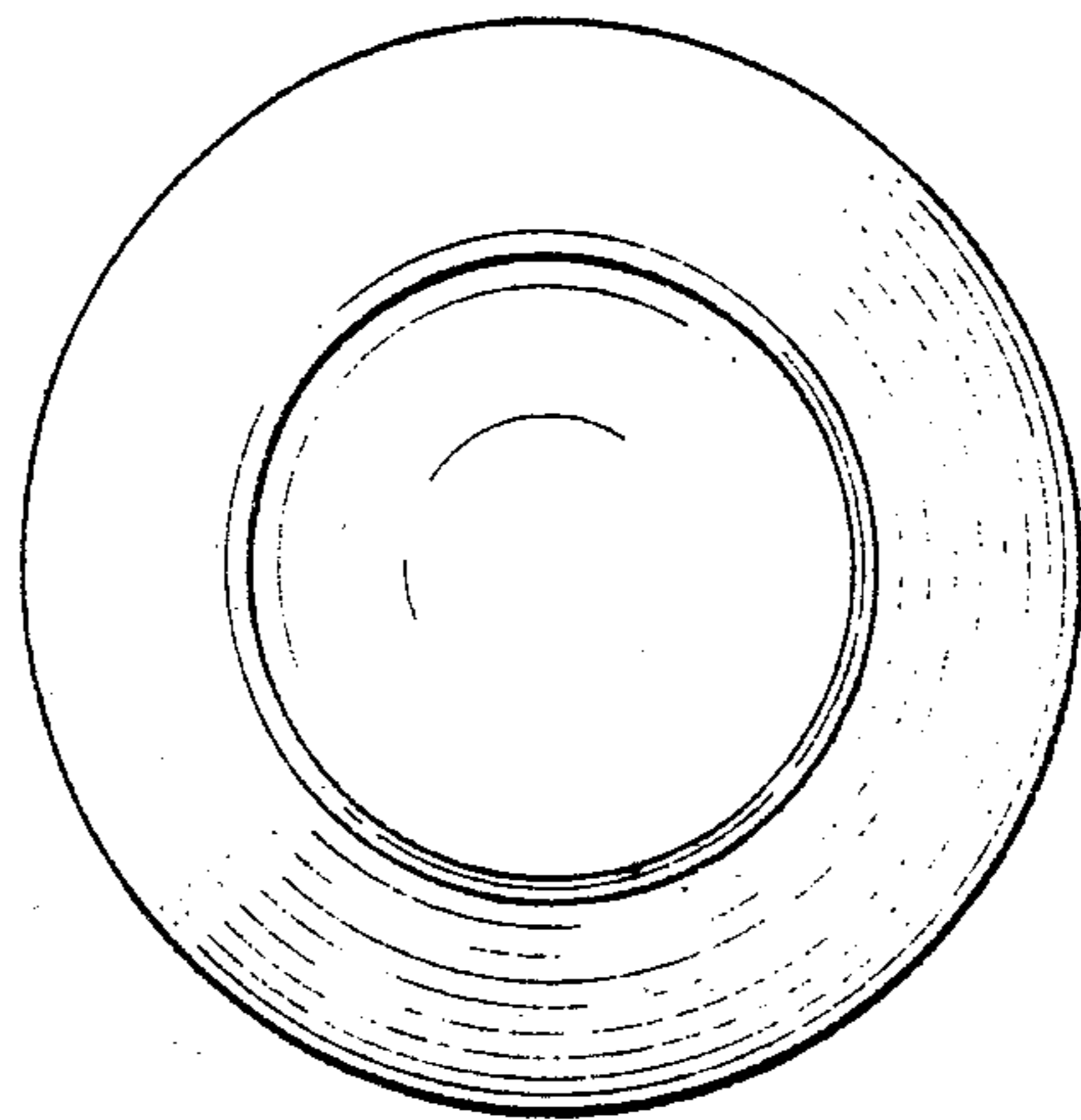

FIG. 11

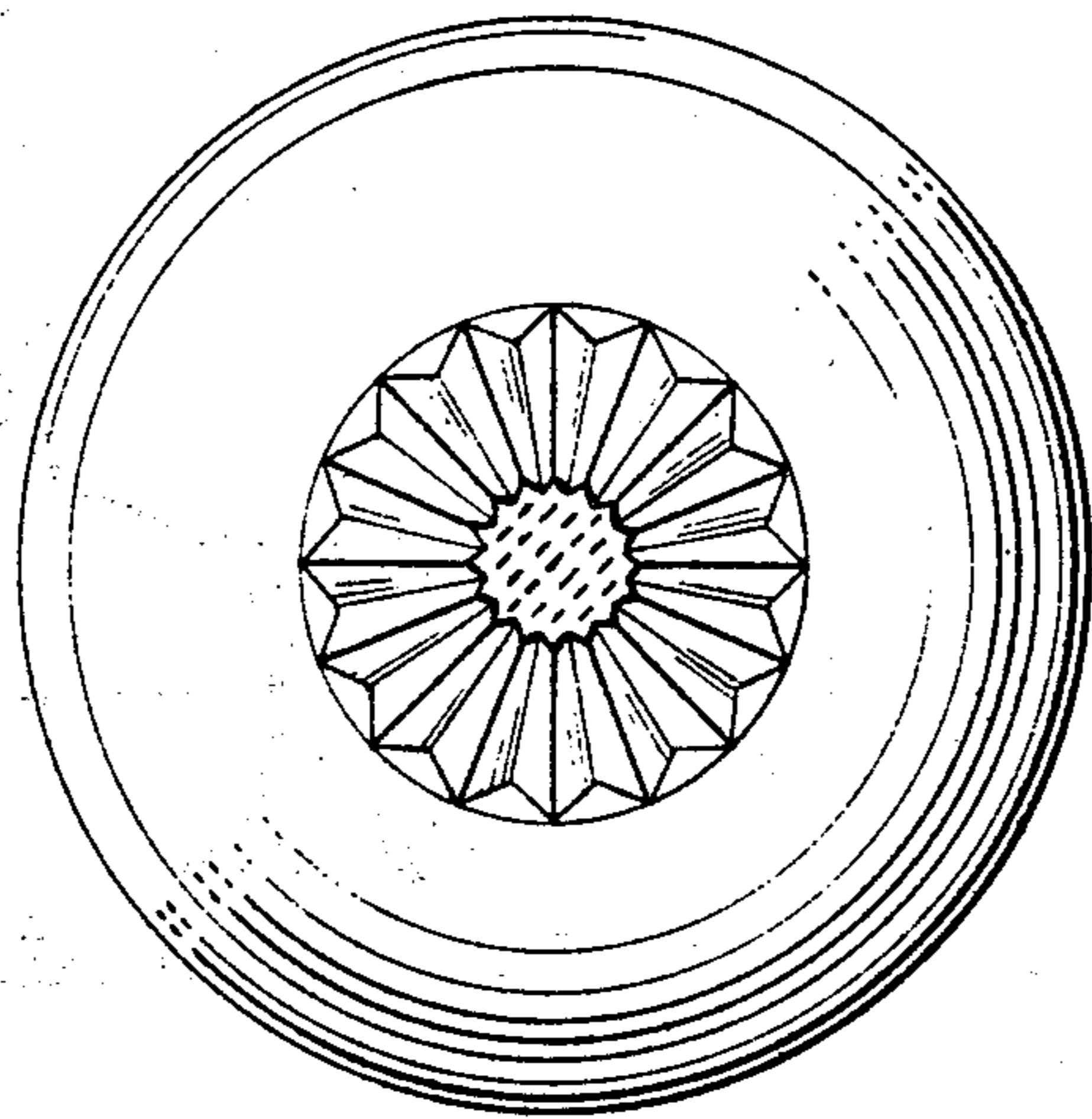

FIG. 12

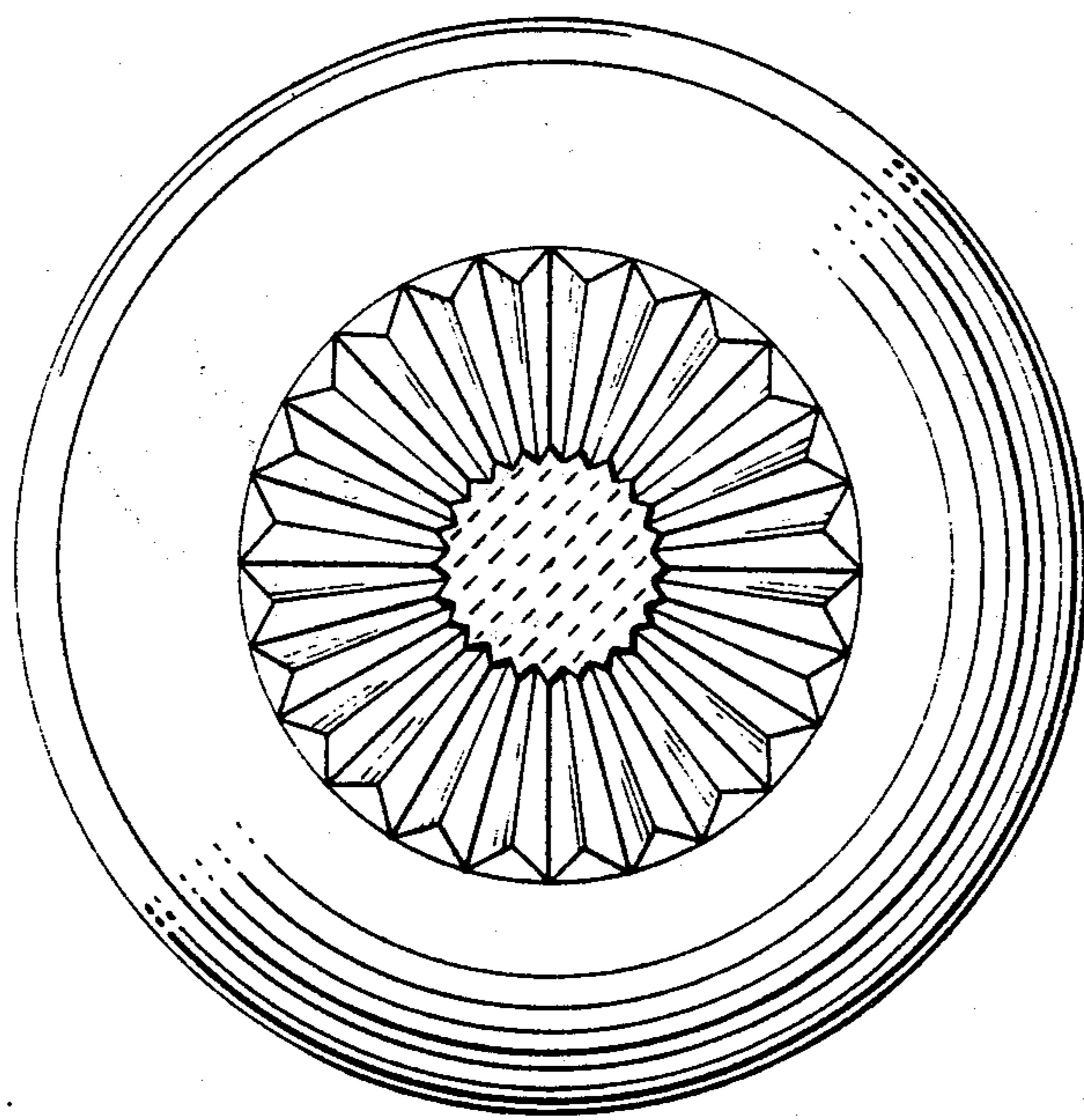

FIG. 15

