

[54] CUP DISPENSING BRACKET

3,389,883 6/1968 Johnson 248/311.2
3,549,226 12/1970 Samson 312/42

[76] Inventor: Erik Blom, Förradsgatan 32, S-542 00 Mariestad, Sweden

Primary Examiner—B. J. Bullock
Assistant Examiner—Suzanne N. Gitlin
Attorney, Agent, or Firm—Browdy and Neimark

[**] Term: 14 Years

[21] Appl. No.: 522,722

[57] CLAIM

[22] Filed: Aug. 12, 1983

The ornamental design for a cup dispensing bracket, as shown.

[30] Foreign Application Priority Data

Feb. 18, 1983 [AU] Australia 528.682

[52] U.S. Cl. D6/516

[58] Field of Search D6/515, 516, 512;
211/49.1; 312/42, 43; 221/193, 194, 282, 283

DESCRIPTION

[56] References Cited

U.S. PATENT DOCUMENTS

D. 274,584 7/1984 Crouse D6/535
1,130,882 3/1915 Bohlman 248/315
3,211,329 10/1965 Boyd 221/283

FIG. 1 is a bottom, rear perspective view of a cup dispensing bracket showing my new design;
FIG. 2 is a front elevational view thereof;
FIG. 3 is a rear elevational view thereof;
FIG. 4 is a side elevational view taken from the right of FIG. 2;
FIG. 5 is a side elevational view taken from the left of FIG. 2;
FIG. 6 is a top plan view thereof;
FIG. 7 is a bottom plan view thereof.

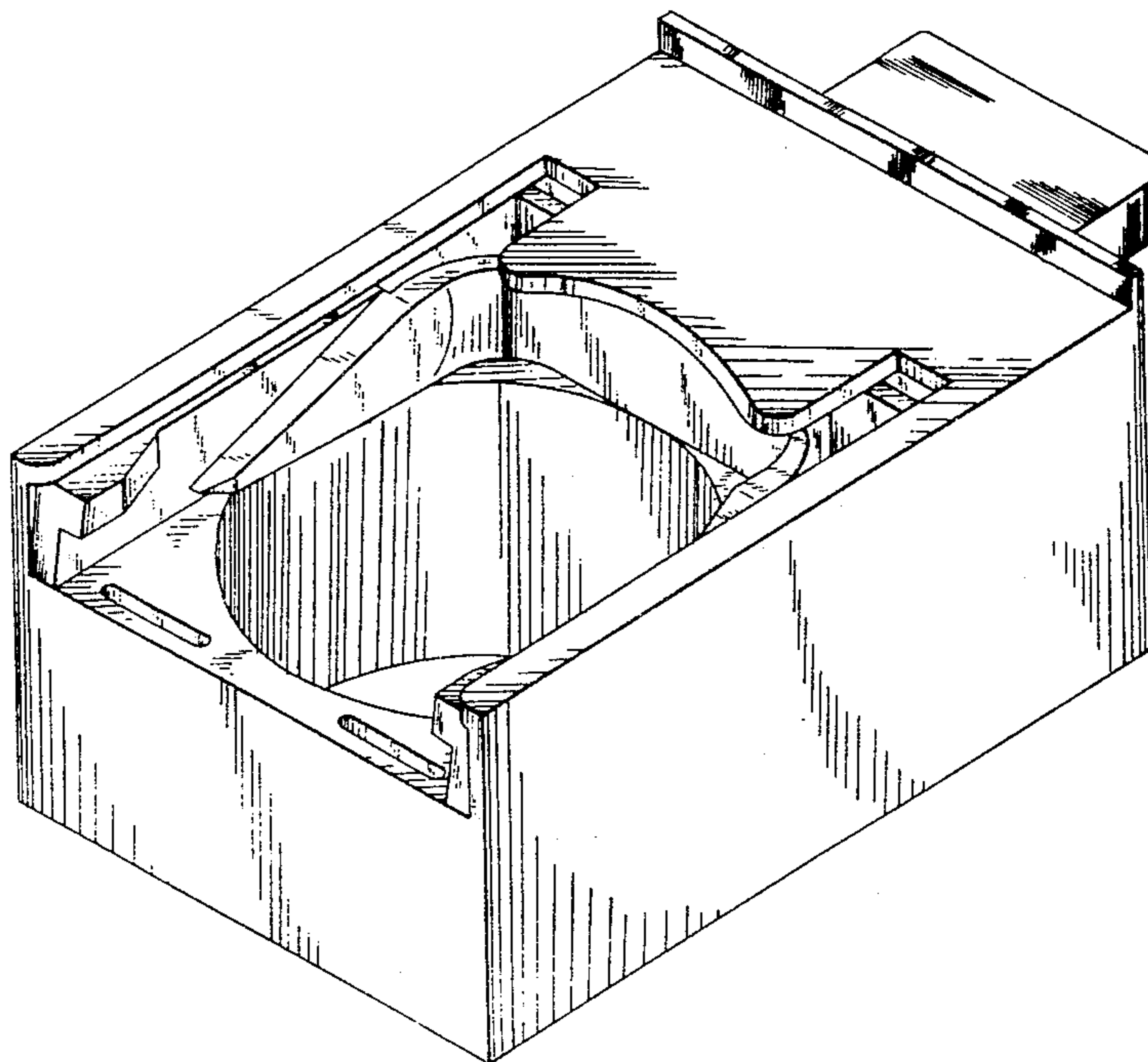

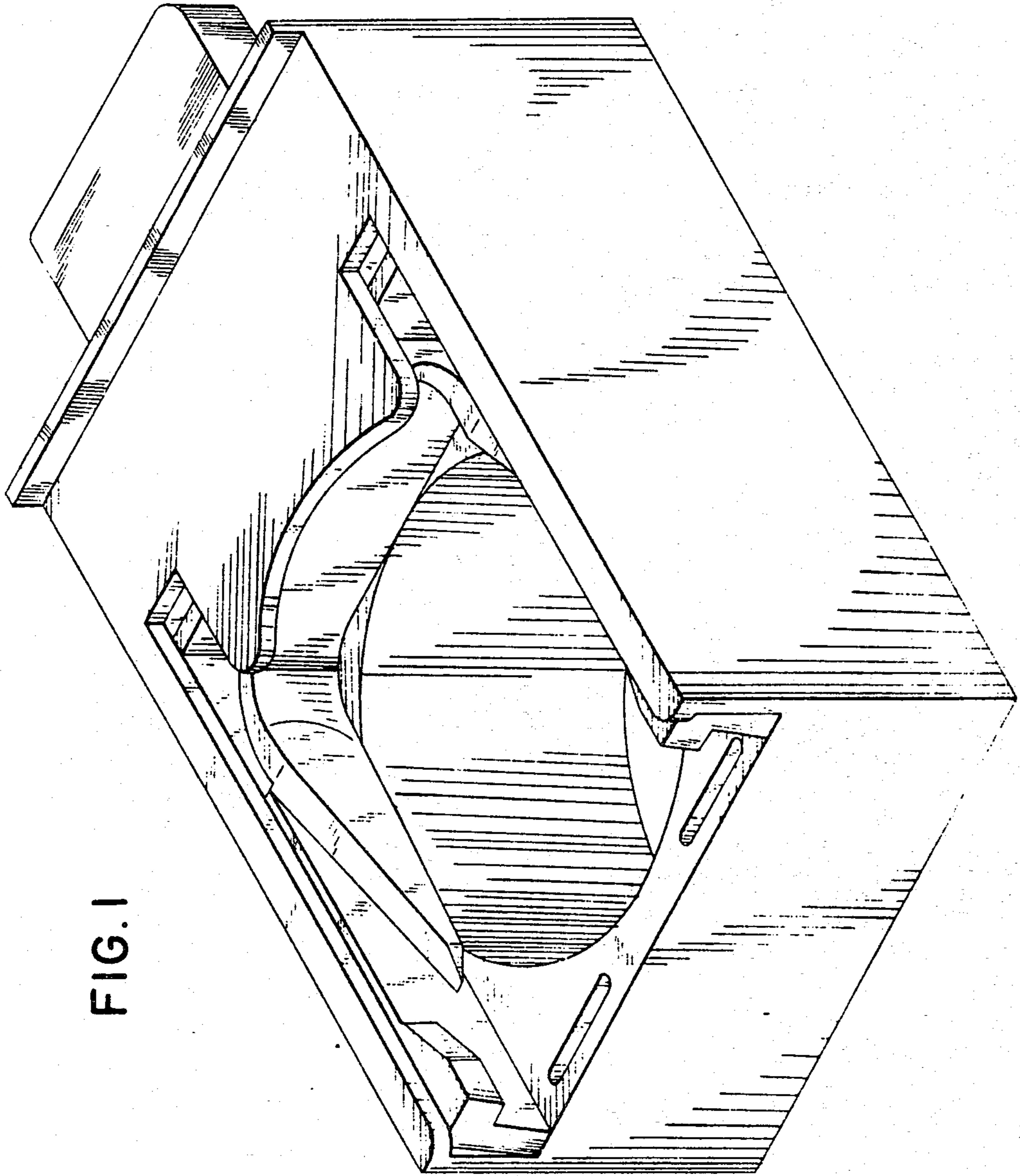

FIG. 1

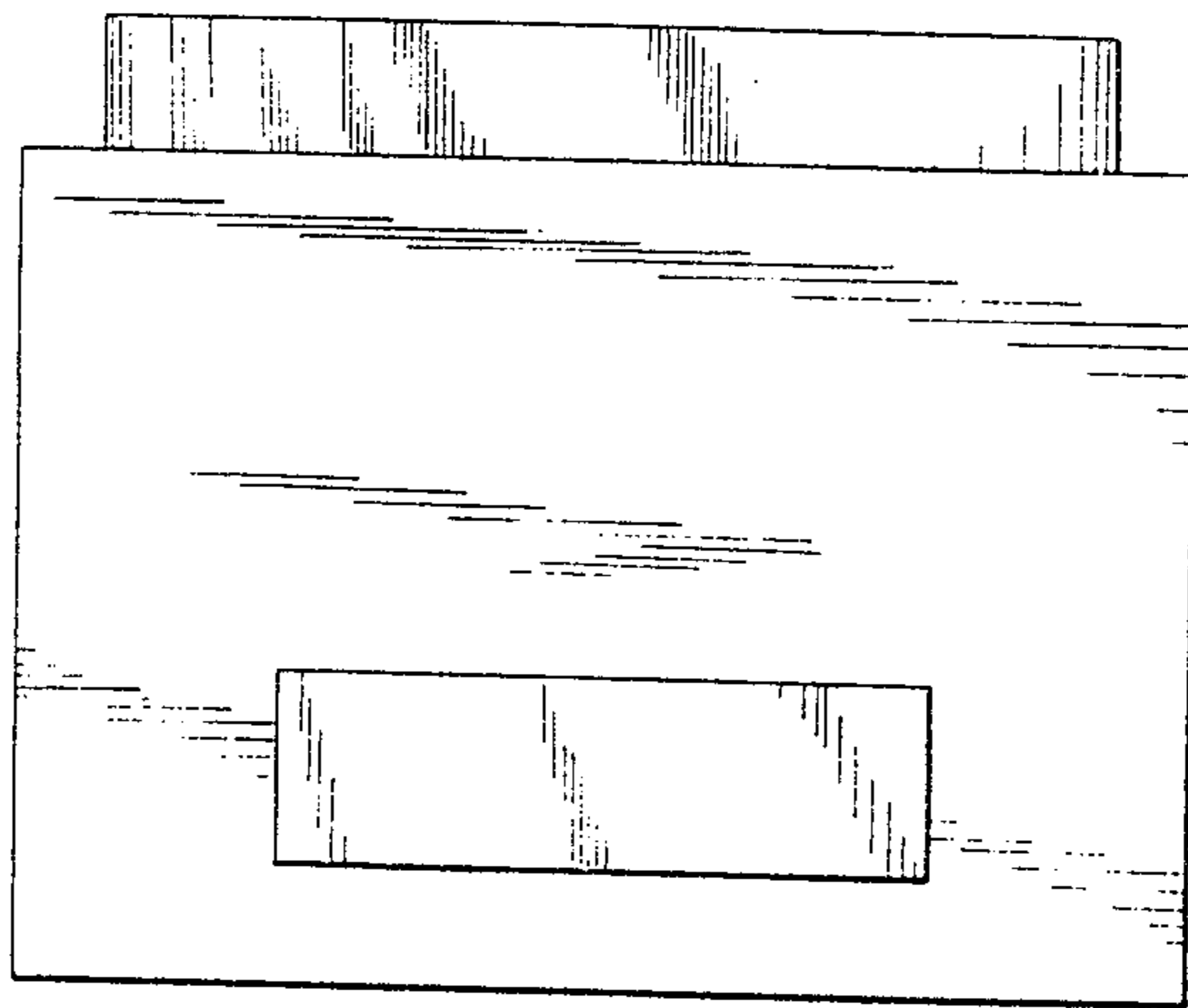

FIG. 2

FIG. 3

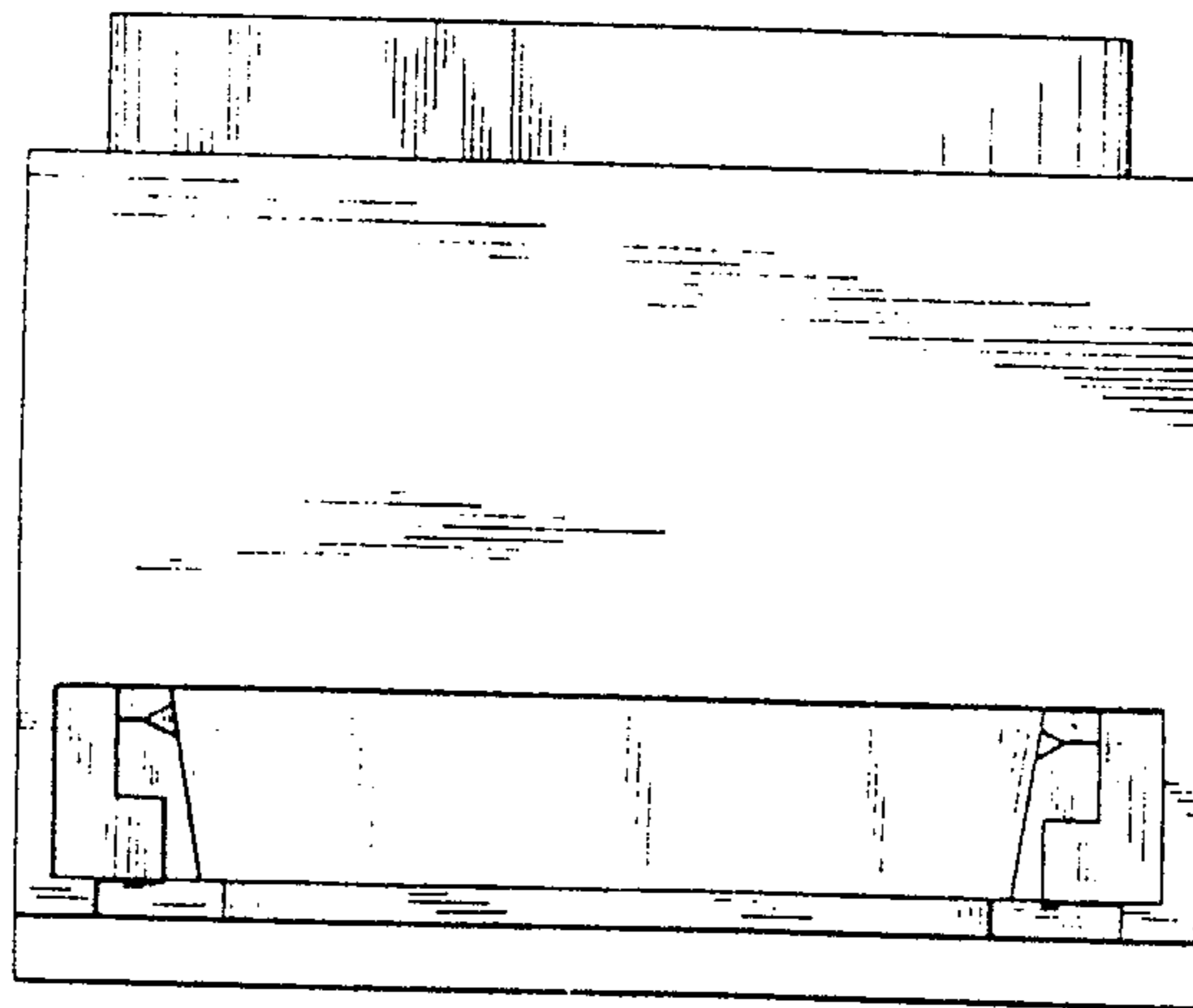

FIG. 4

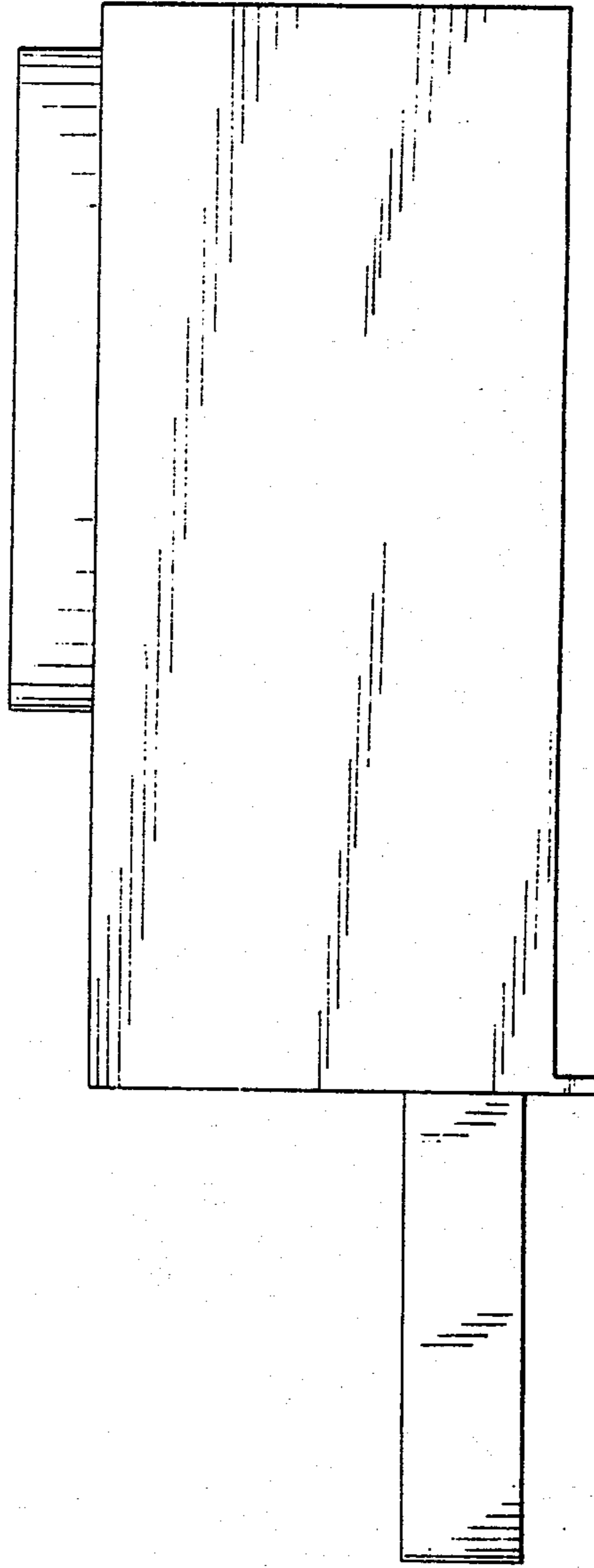

FIG. 5

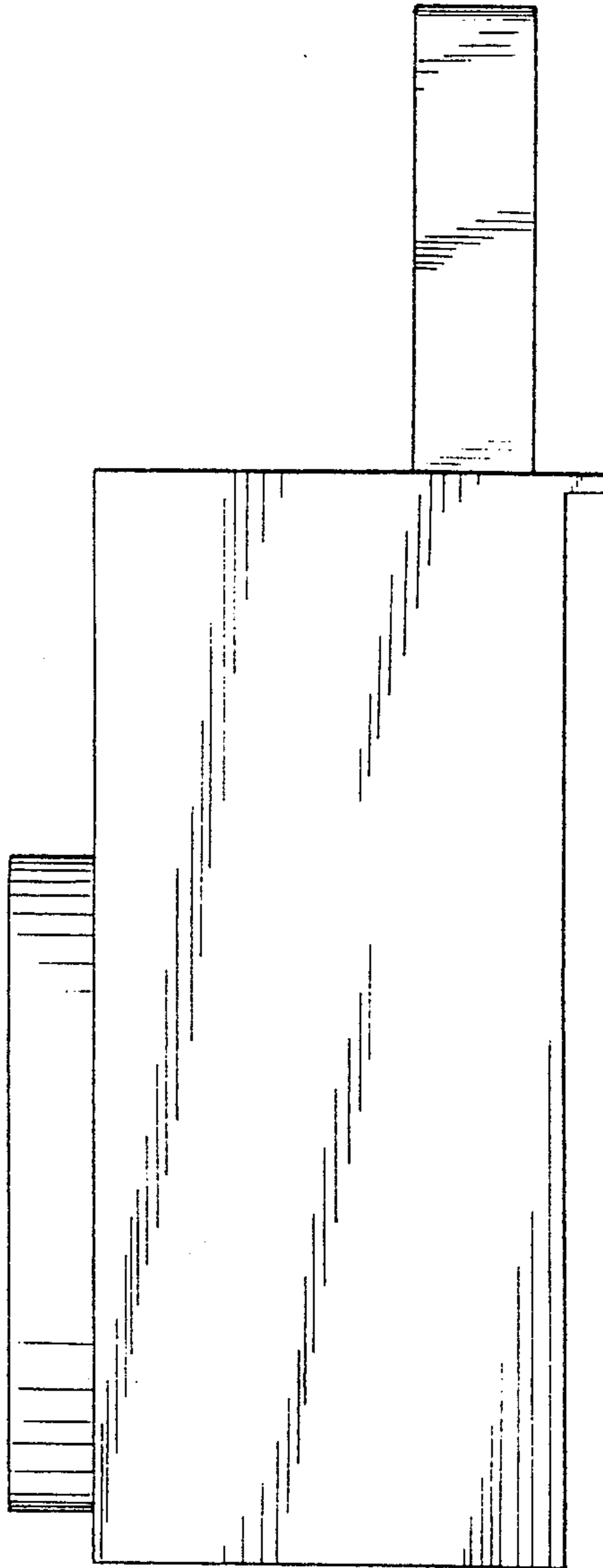

FIG. 6

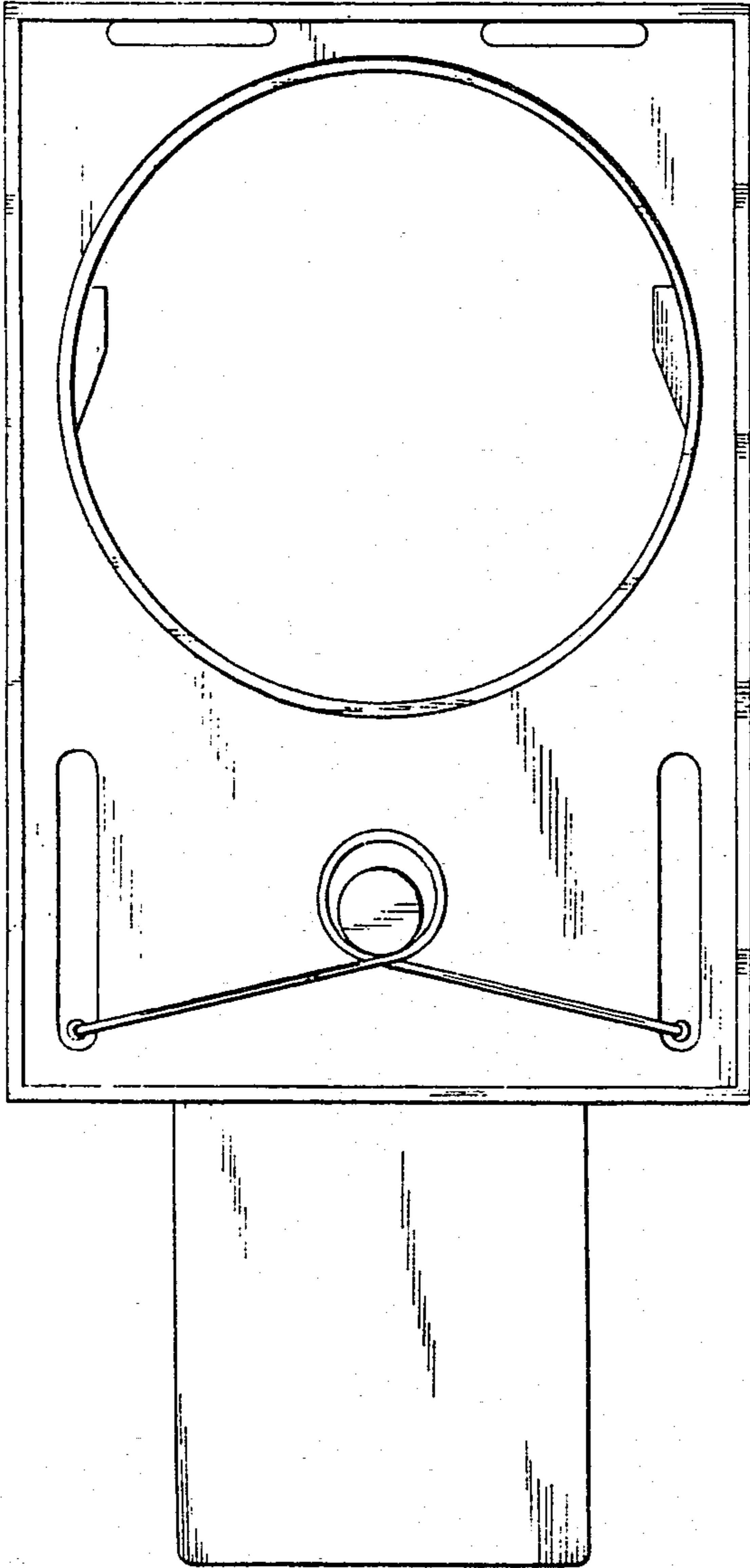

FIG. 7

