

[54] **STEAM IRON**

[76] **Inventor: John S. Doyel, 404 W. 20th St., New York, N.Y. 10011**

[\*\*] **Term: 14 Years**

[21] **Appl. No.: 653,517**

[22] **Filed: Sep. 21, 1984**

[52] **U.S. Cl. .... D32/69**

[58] **Field of Search .... D32/68-73;  
38/69, 74, 75, 77.1-77.9, 88, 94, 96, 142;  
219/245-259, 271-276**

[56] **References Cited**

**U.S. PATENT DOCUMENTS**

3,949,499	4/1976	Schaeffer et al. ....	38/77.3
4,206,340	6/1980	Osrow et al. ....	38/69 X
4,233,763	11/1980	McMullen ....	38/77.83
4,496,826	1/1985	Osrow ....	38/69 X

**FOREIGN PATENT DOCUMENTS**

2445824	1/1976	Fed. Rep. of Germany .....	38/69
---------	--------	----------------------------	-------

*Primary Examiner*—Catherine E. Kemper

*Attorney, Agent, or Firm*—Cooper, Dumham, Clark, Griffin & Moran

[57] **CLAIM**

The ornamental design for a steam iron, as shown and described.

**DESCRIPTION**

FIG. 1 is a perspective view of a steam iron showing my new design, in position for storage and with a cup mounted on the back end thereof.

FIG. 2 is a top plan view thereof, without the cup.

FIG. 3 is a side elevational view thereof, without the cup, the other side being a mirror image.

FIG. 4 is a front elevational view thereof.

FIG. 5 is a back elevational view thereof, without the cup.

FIG. 6 is a bottom plan view thereof, without the cup.

FIG. 7 is a sectional view thereof along line 7—7 of FIG. 3.

FIG. 8 is a perspective view of the cup.

FIG. 9 is a top plan view of the cup.

FIG. 10 is a front elevational view of the cup.

FIG. 11 is a side elevational view of the cup, the other side being a mirror image.

FIG. 12 is a back elevational view of the cup.

FIG. 13 is a bottom plan view of the cup.

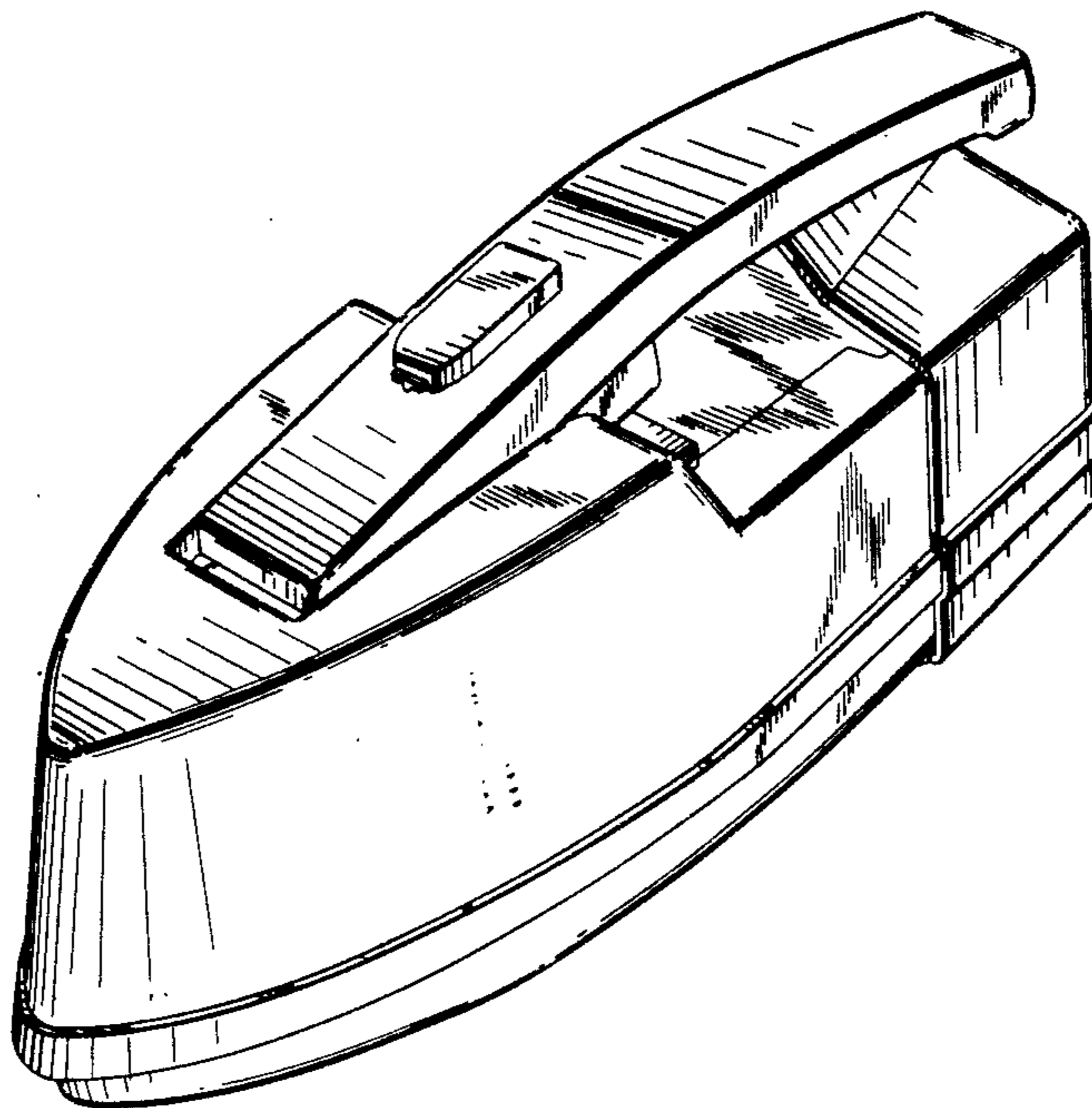

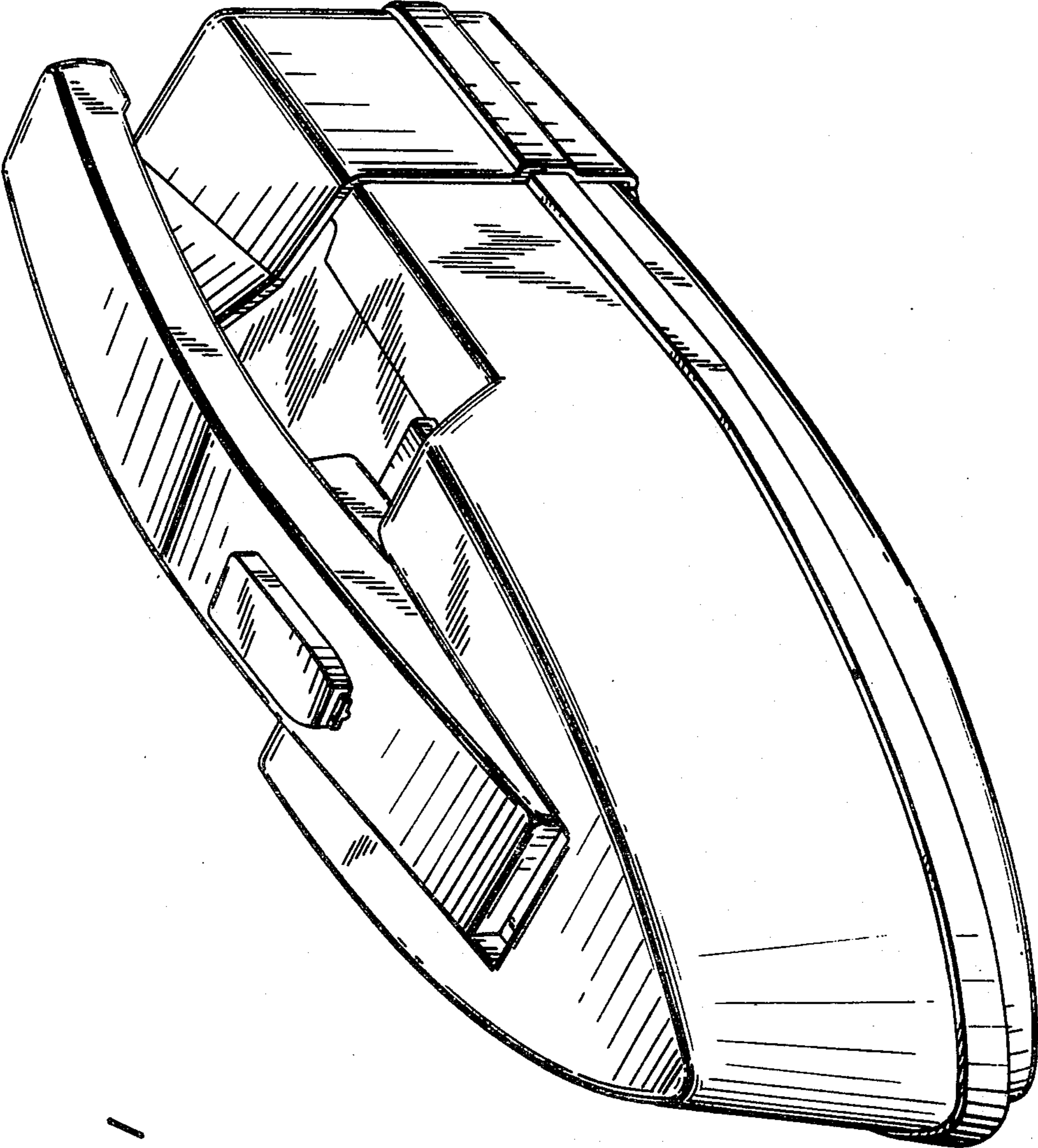

FIG. 1

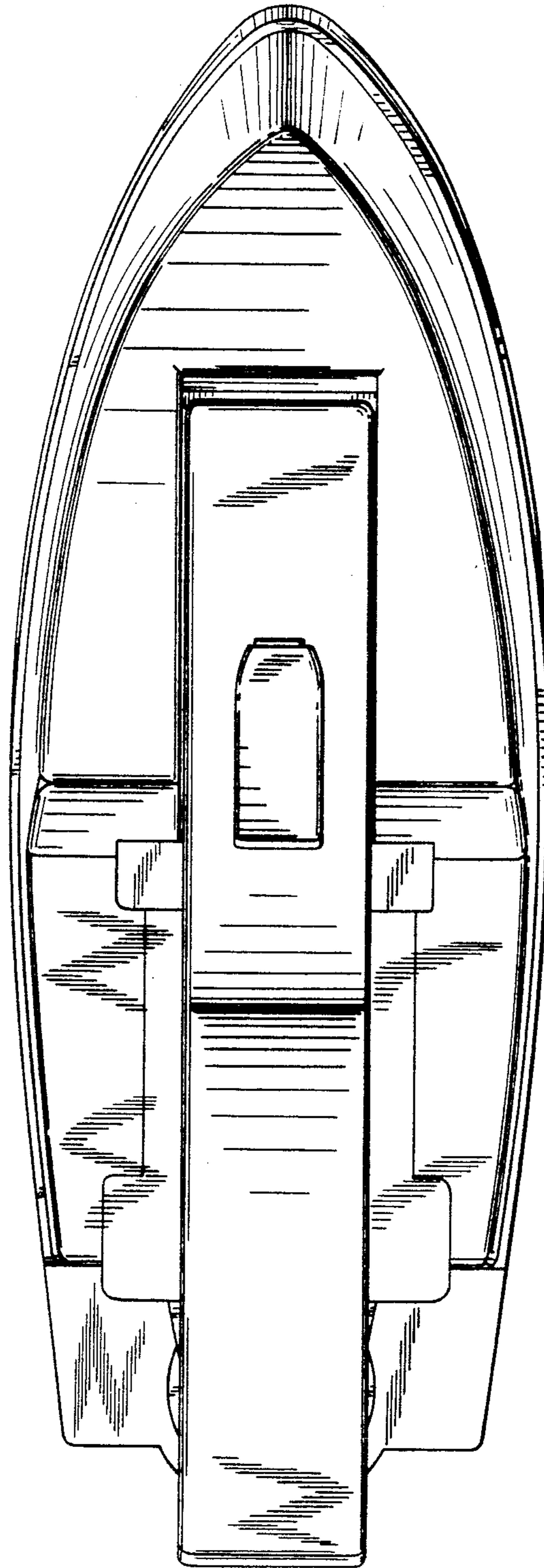

FIG. 2

FIG. 3

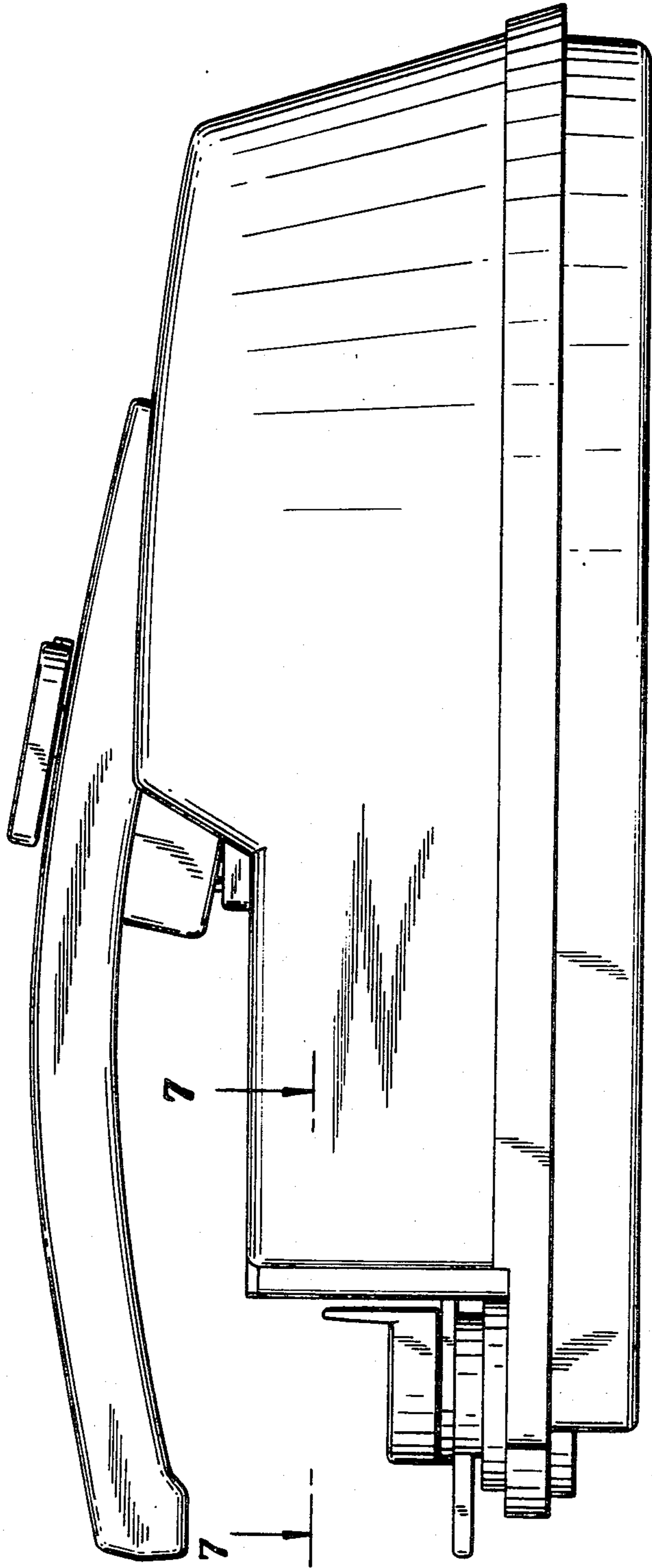



FIG. 5

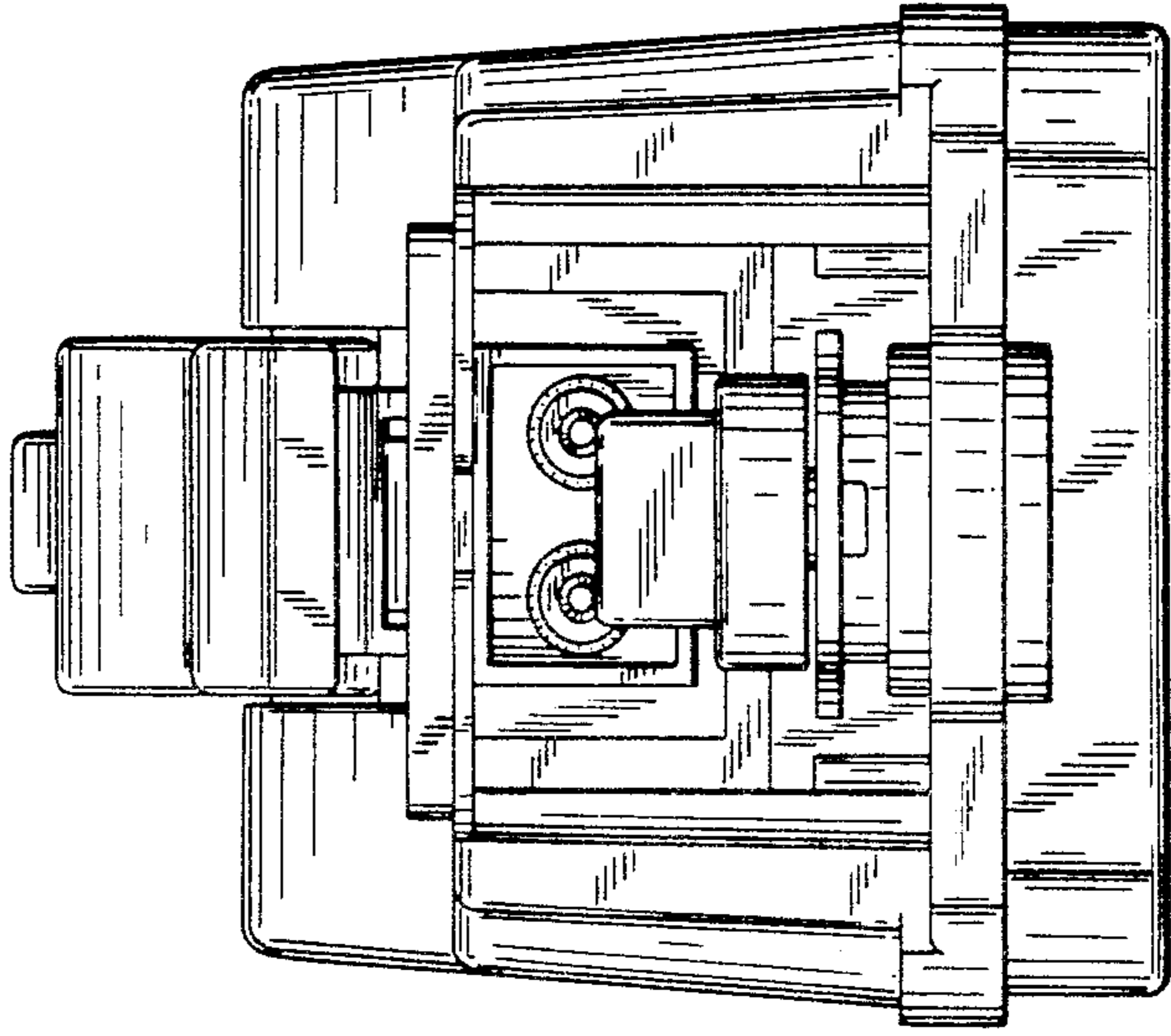
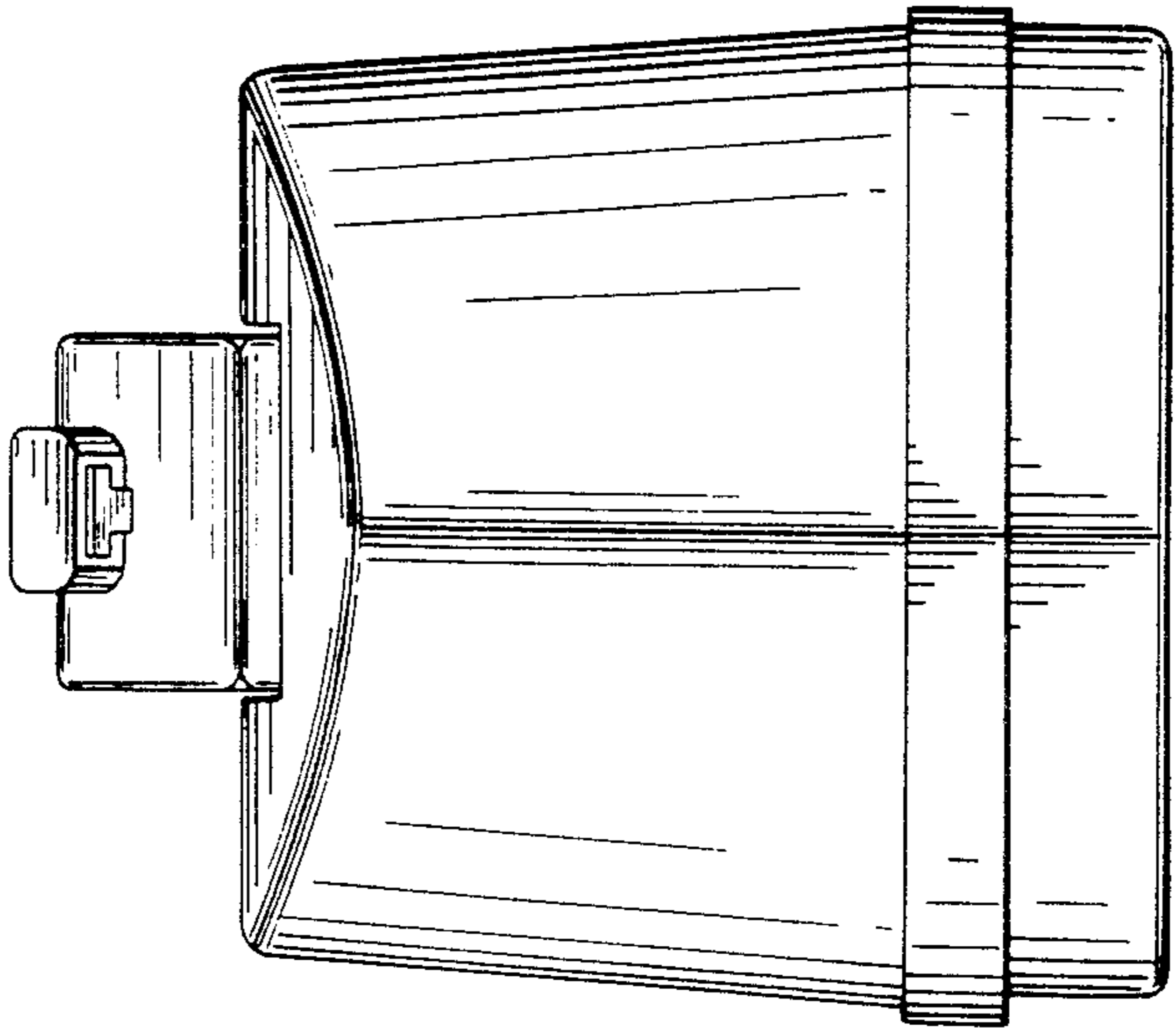

FIG. 4



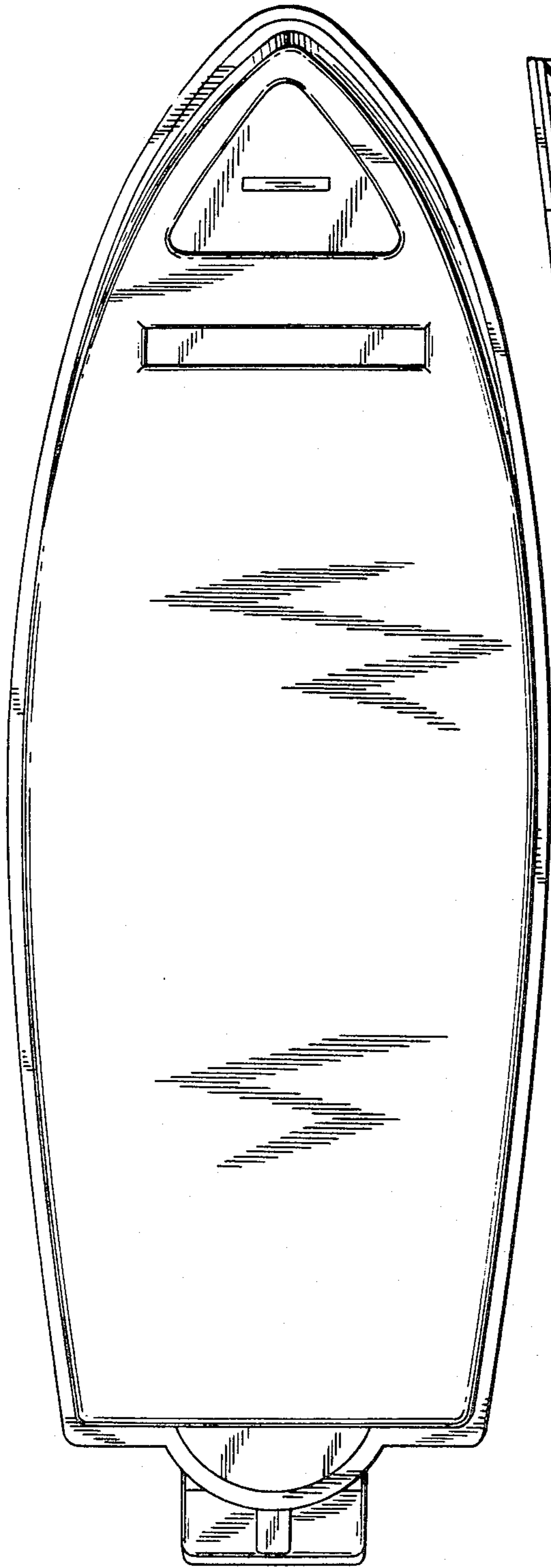

FIG. 6

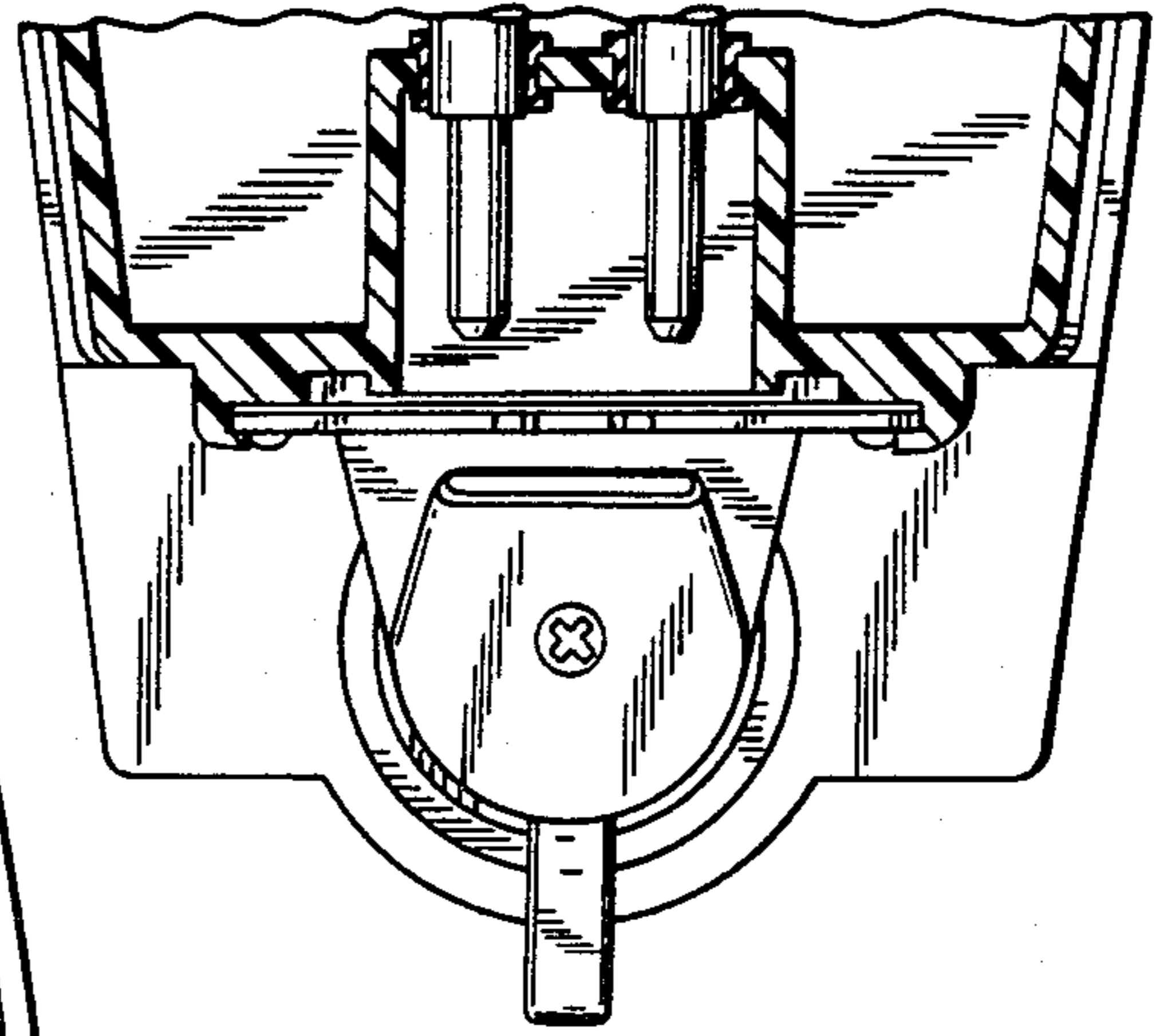
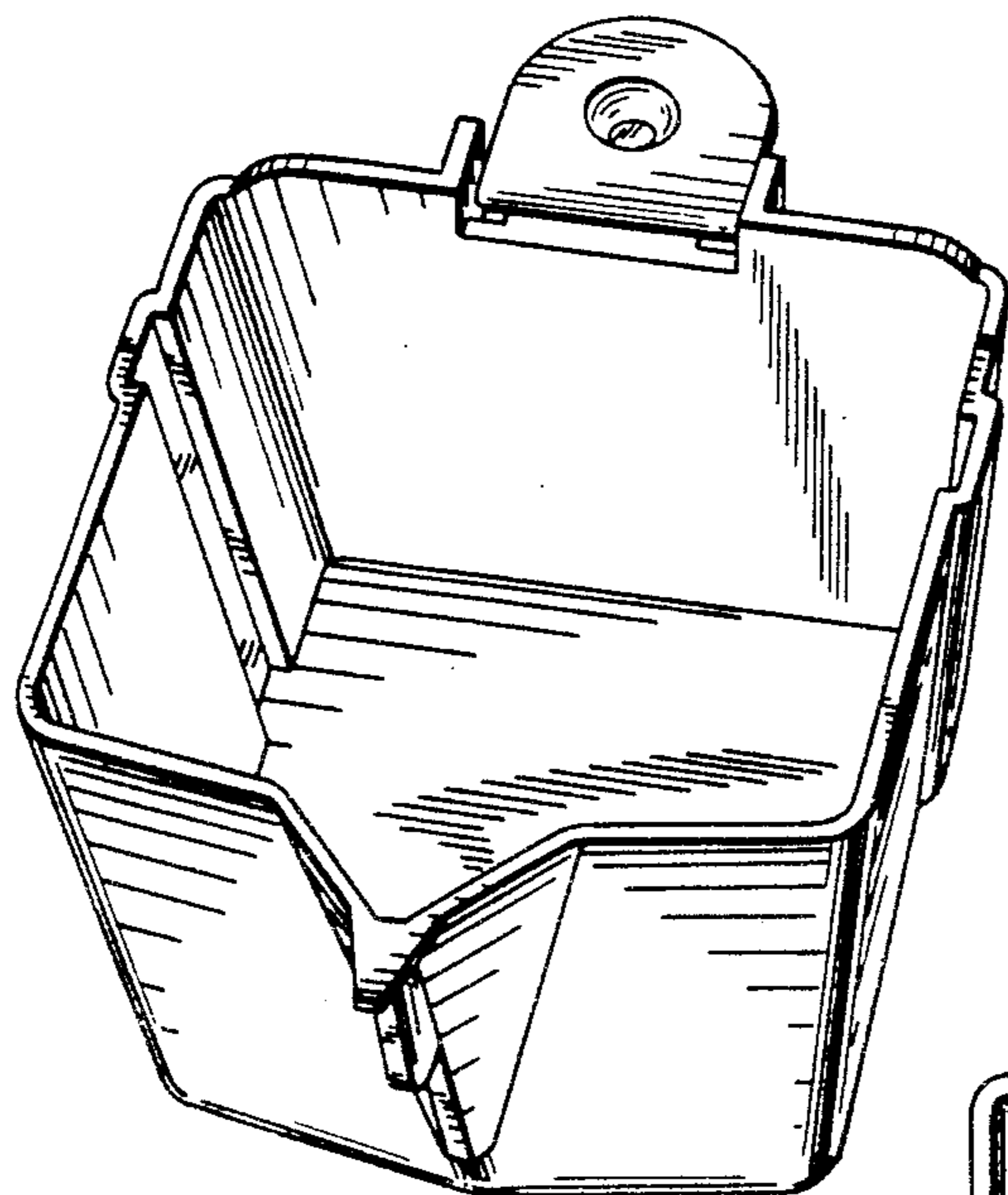
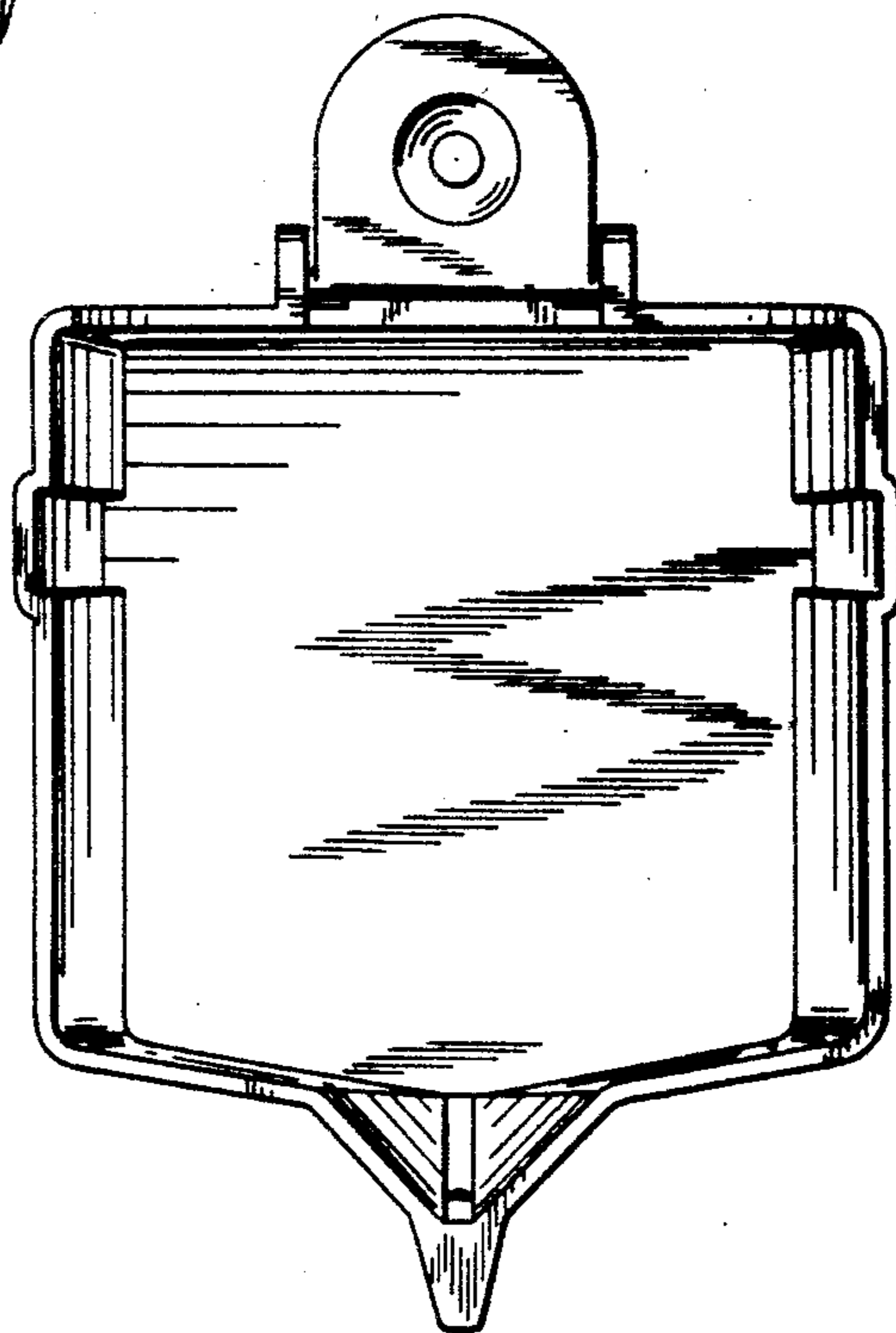

FIG. 7



*FIG. 8*



*FIG. 9*

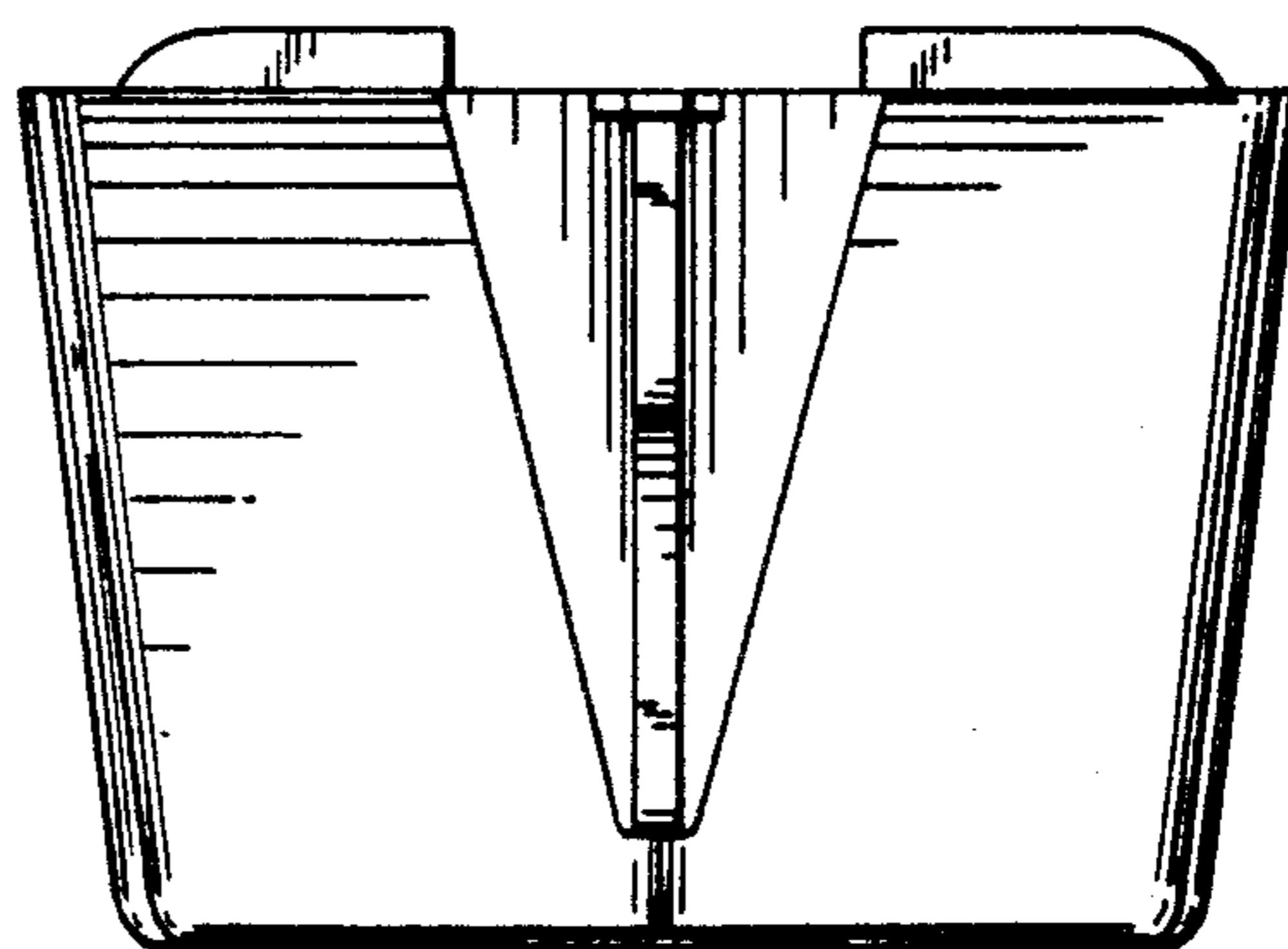

*FIG. 10*

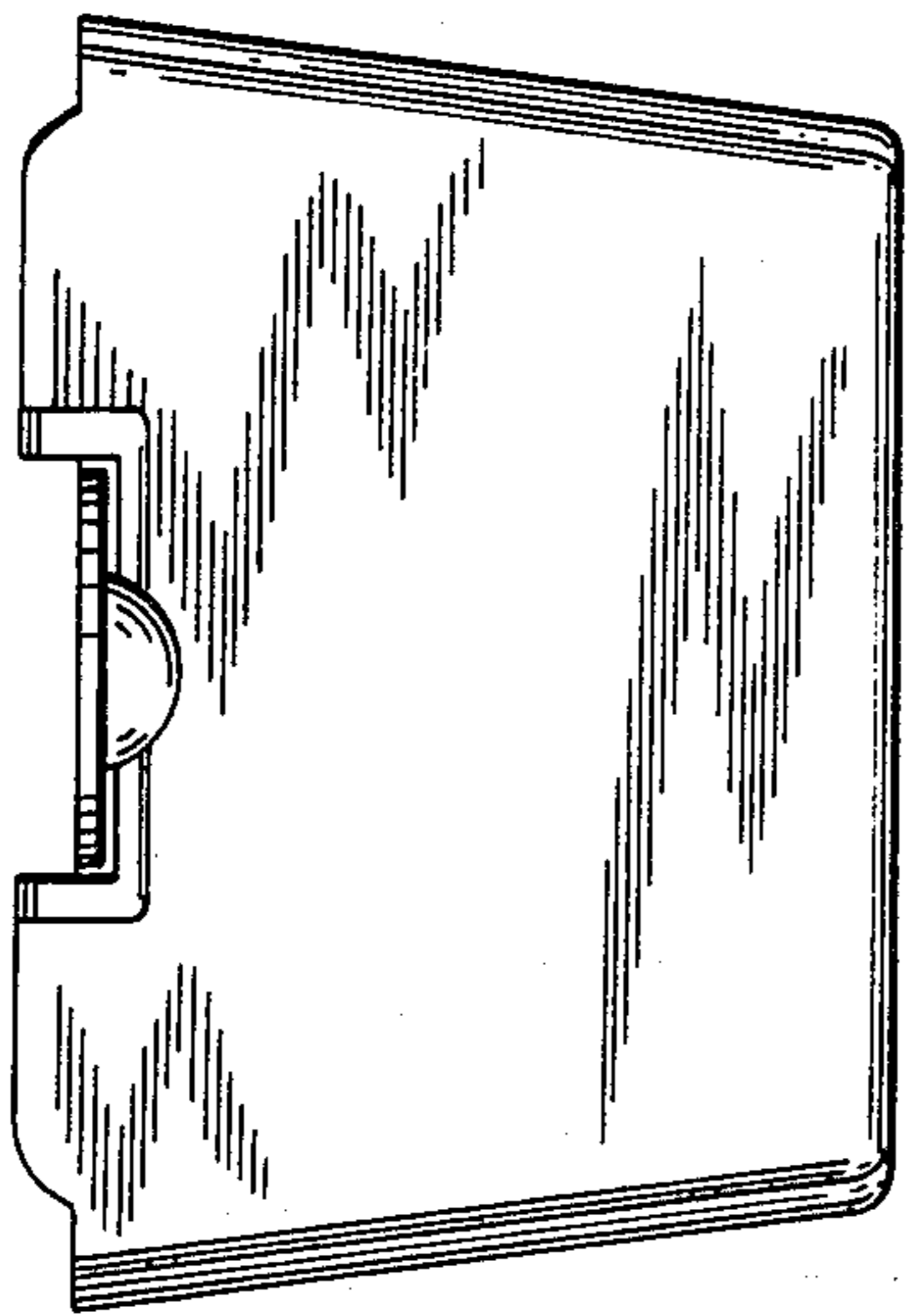
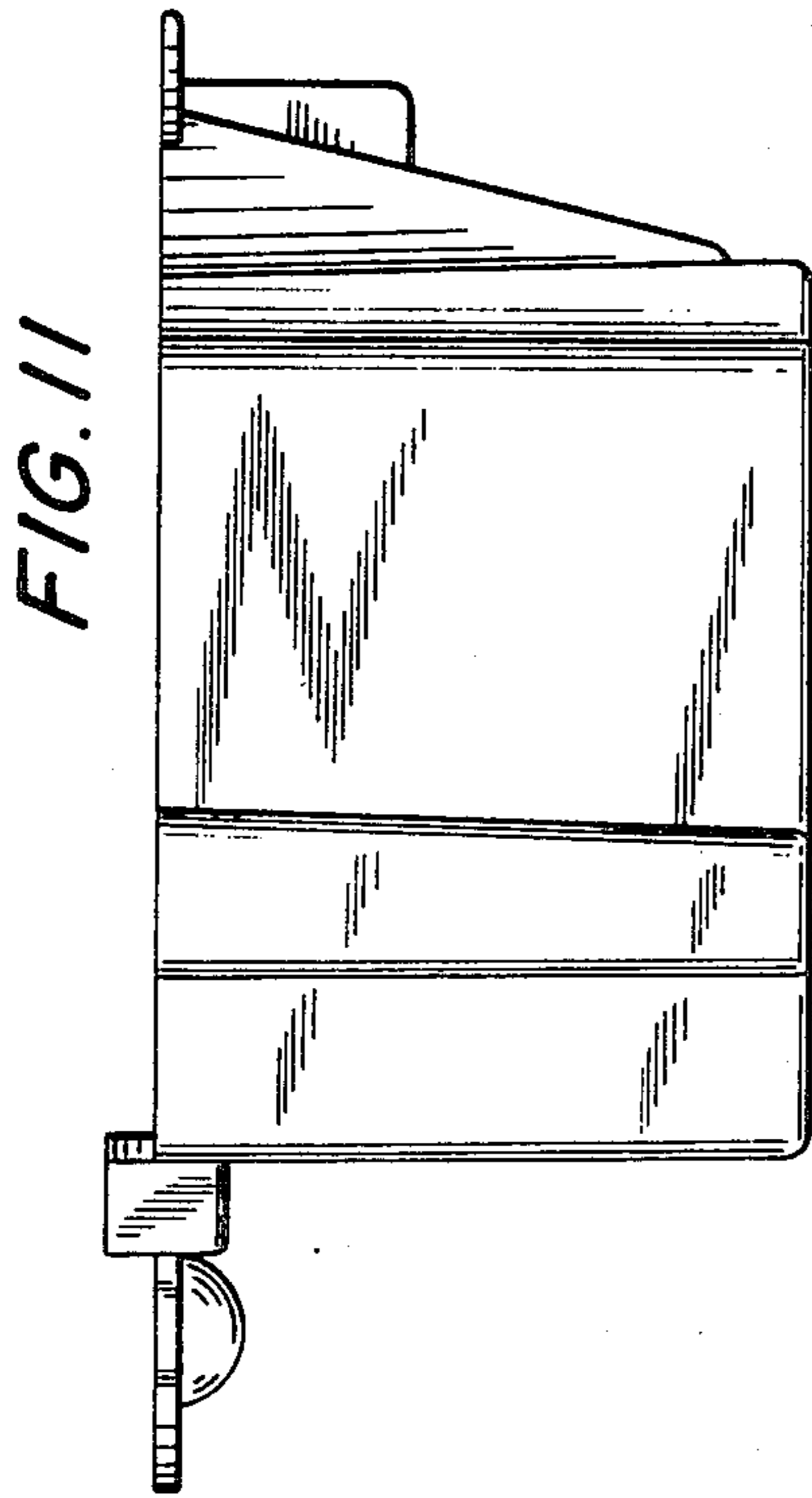

FIG. 12

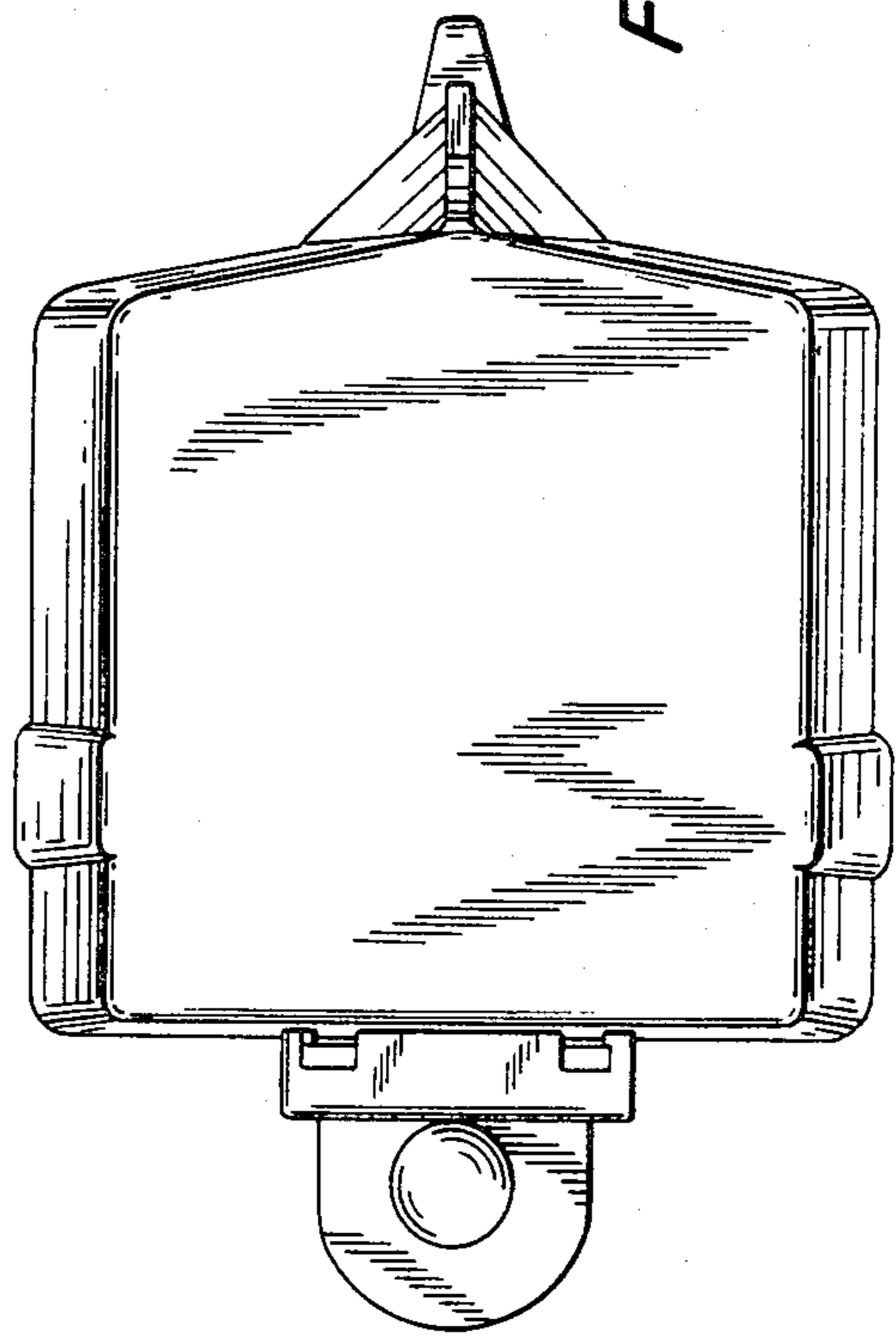

FIG. 13