

[54] PERSONAL COMPUTER

[75] Inventors: Myron F. Davis; Willis Y. Jordan, III, both of Boca Raton, Fla.; Walter F. Kraus, LaGrangeville, N.Y.; Harold D. Yeaw, North Palm Beach, Fla.

[73] Assignee: International Business Machines Corporation, Armonk, N.Y.

[**] Term: 14 Years

[21] Appl. No.: 529,901

[22] Filed: Sep. 7, 1983

[52] U.S. Cl. D14/100

[58] Field of Search D14/100, 105, 106, 107, D14/108, 109, 114, 115; 364/708; D13/40, 41

[56] References Cited

U.S. PATENT DOCUMENTS

D. 259,041 4/1981 Ault et al. D14/100

OTHER PUBLICATIONS

Computer Products, 10-1981, p. 29, IBM Personal Computer.

Primary Examiner—Susan J. Lucas

[57] CLAIM

The ornamental design for a personal computer, as shown.

DESCRIPTION

FIG. 1 is a right, top, front perspective view of the personal computer showing our new design; FIG. 2 is a left, rear, bottom perspective view thereof; FIG. 3 is a front elevational view thereof; FIG. 4 is a rear elevational view thereof; FIG. 5 is a left side elevational view thereof; FIG. 6 is a right side elevational view thereof; FIG. 7 is a top plan view thereof; FIG. 8 is a bottom plan view thereof.

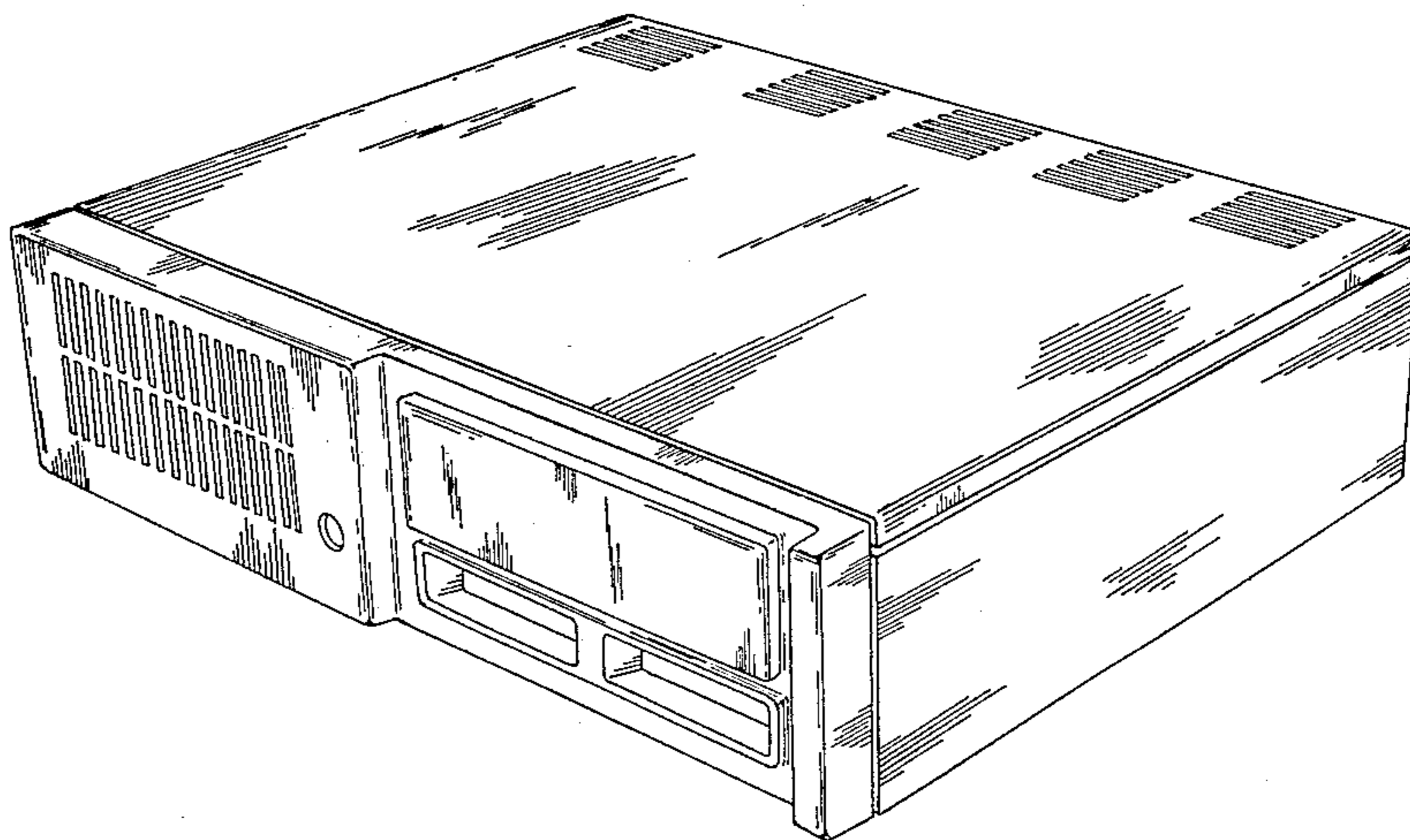

FIG. 1

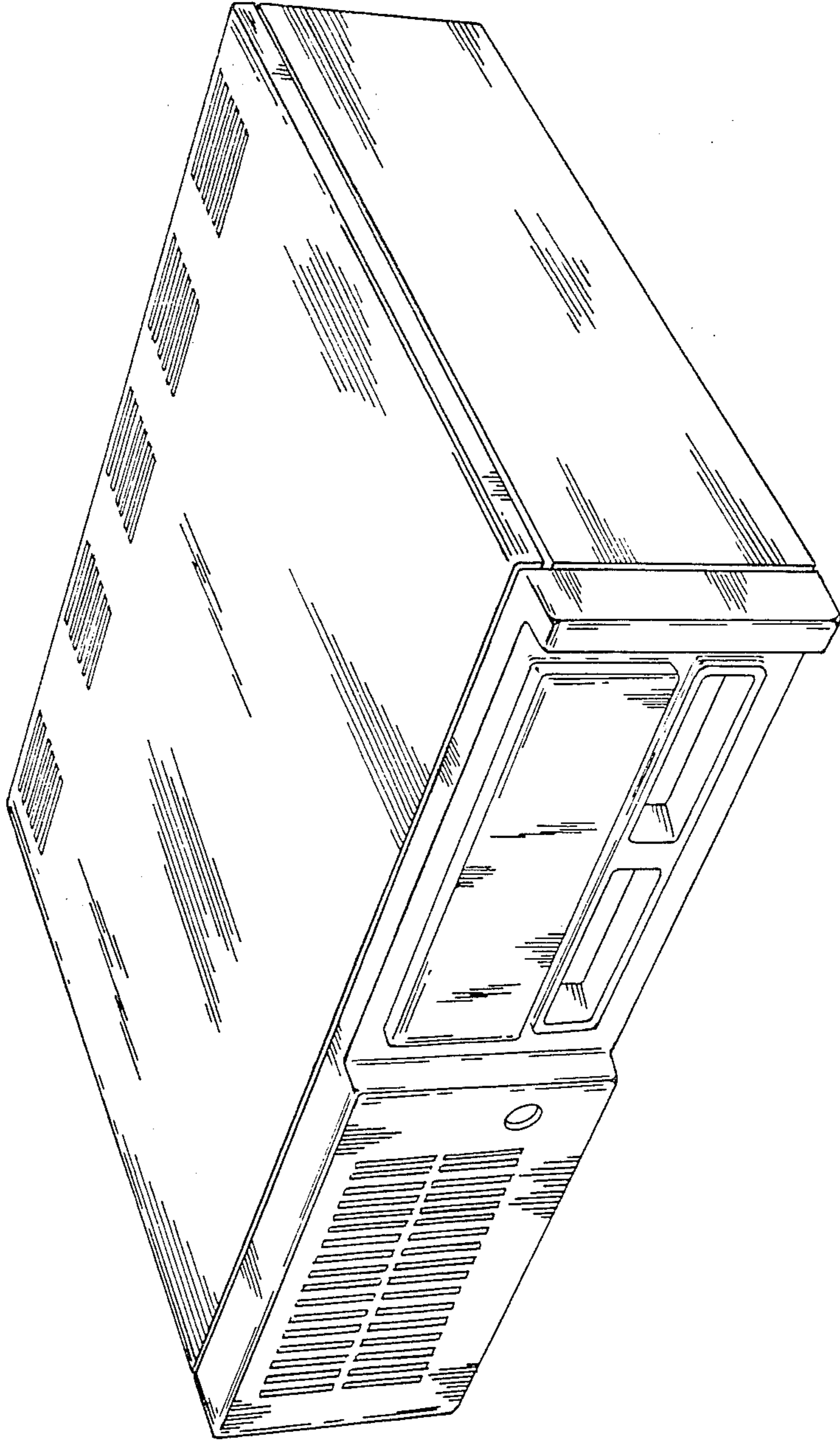

FIG. 2

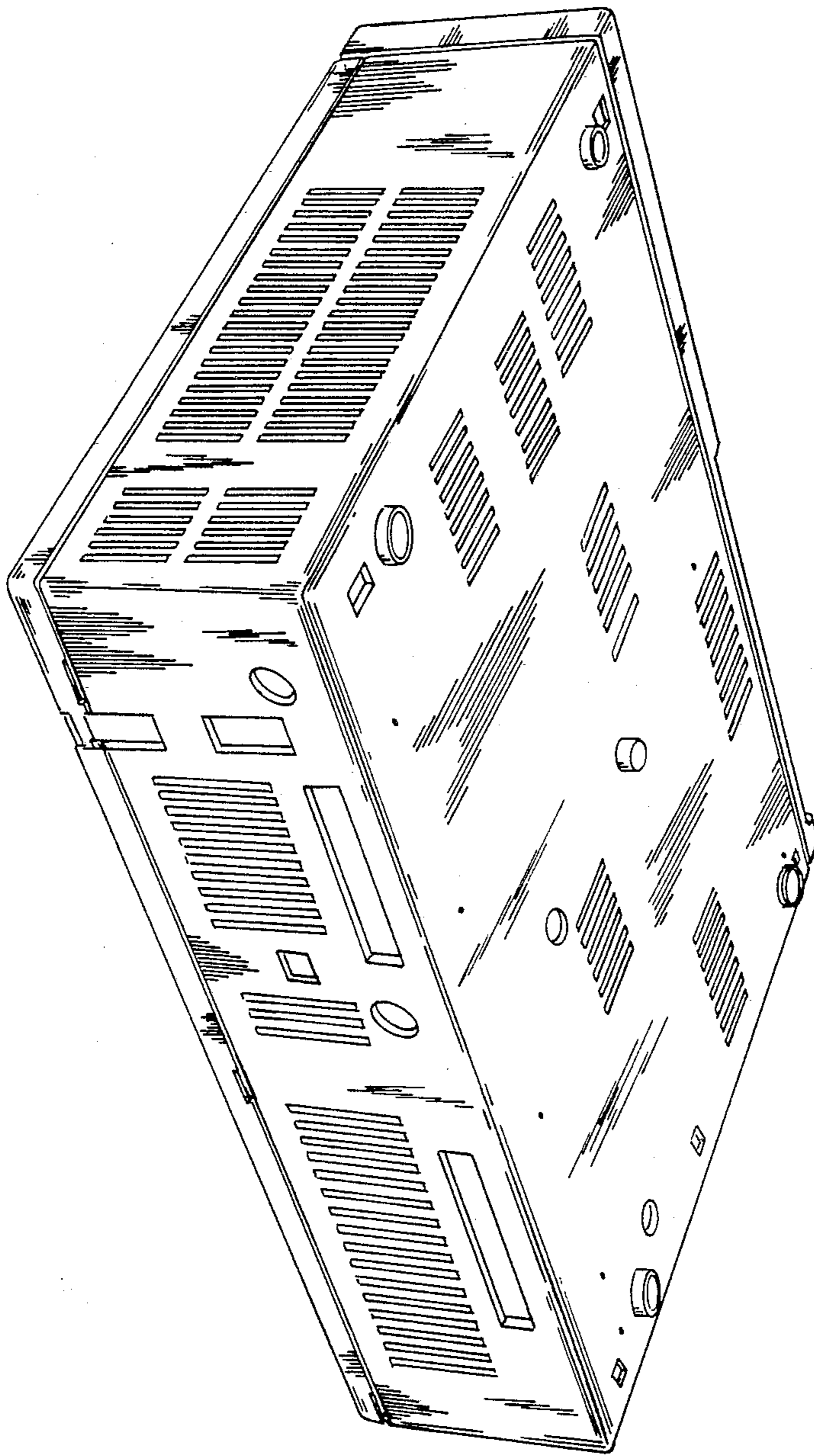

FIG. 3

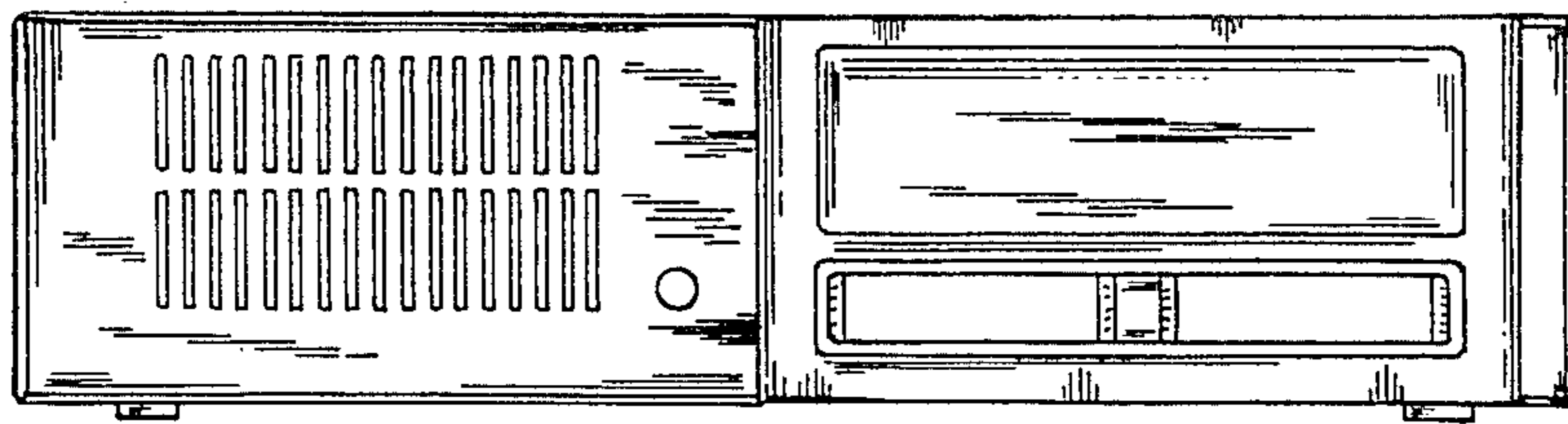

FIG. 4

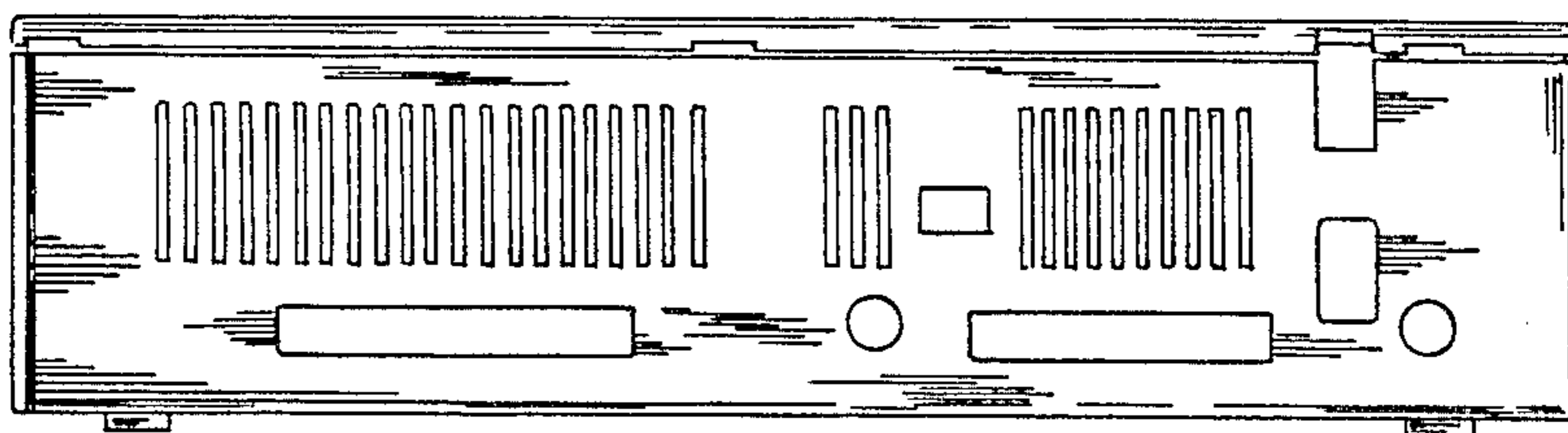

FIG. 6

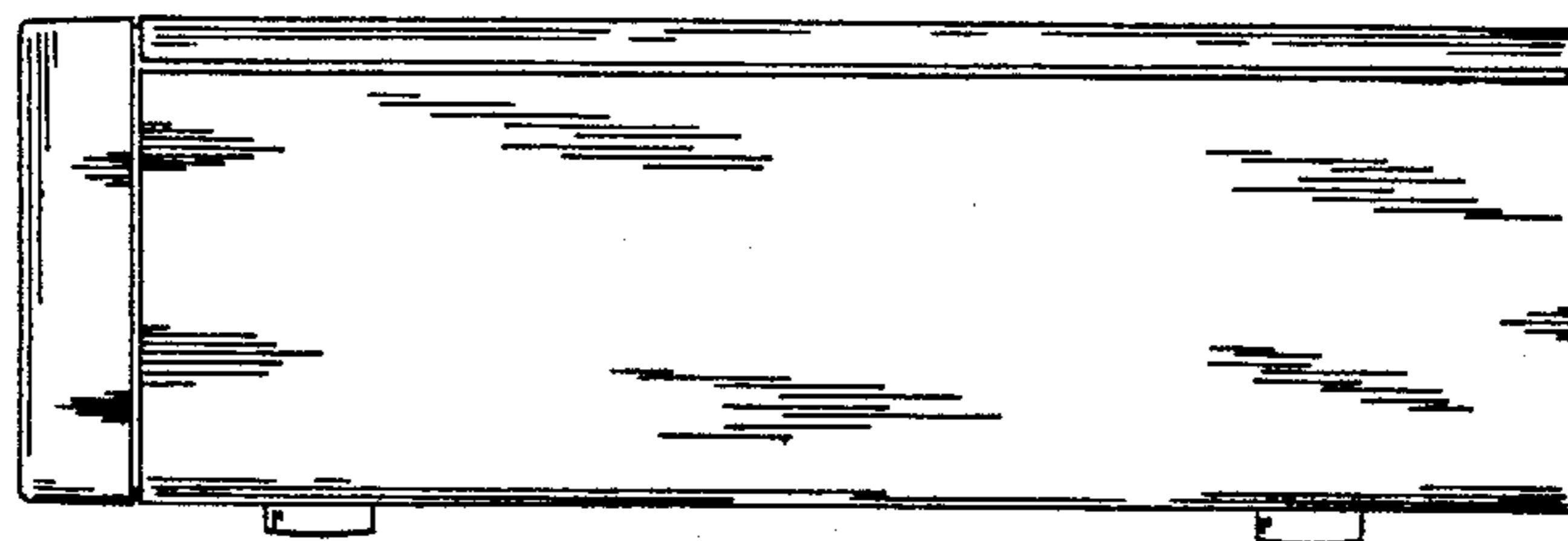

FIG. 5

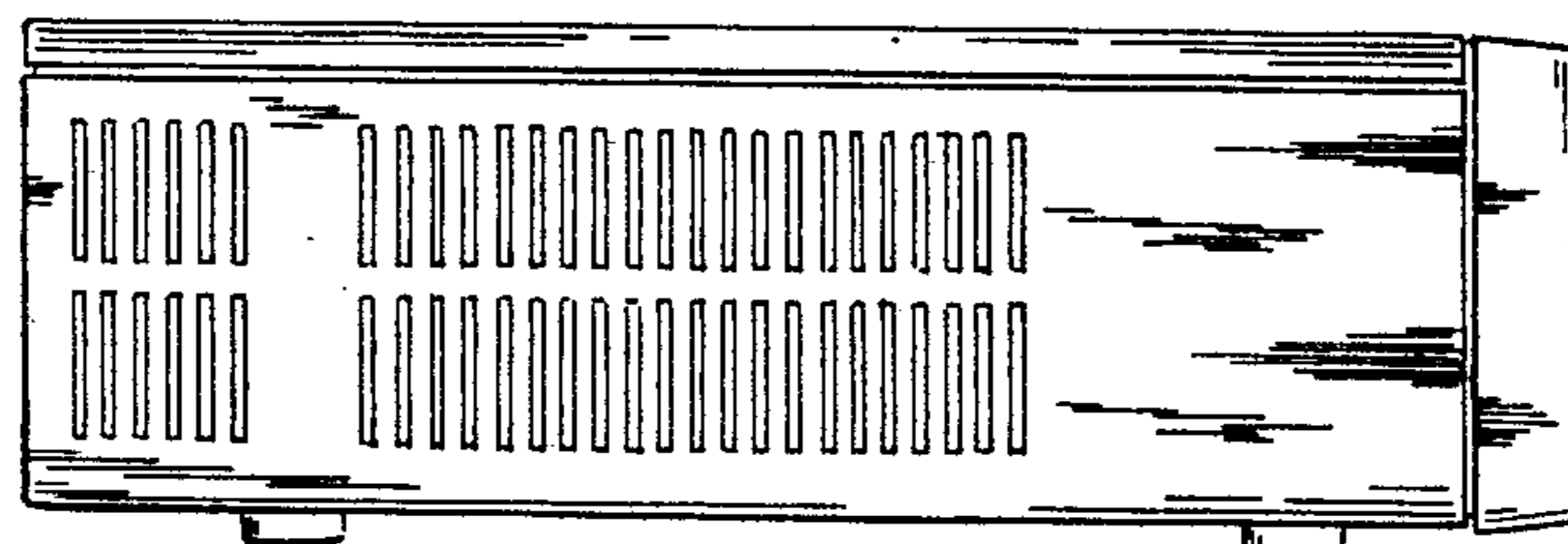

FIG. 7

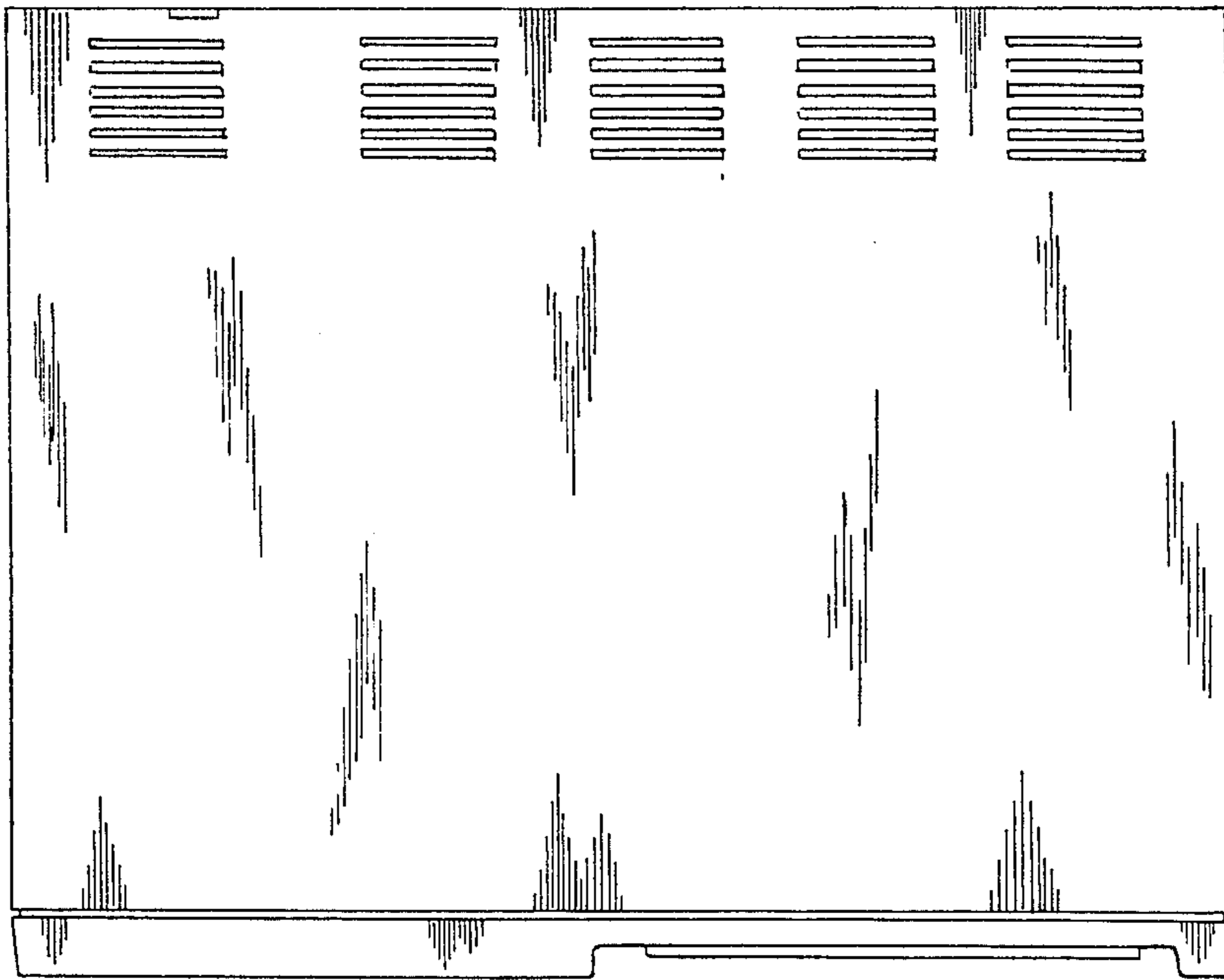

FIG. 8

