

[54] WATCH CASE

[75] Inventor: Harumichi Kabaya, Yokohama, Japan

[73] Assignee: Citizen Watch Co., Ltd., Tokyo, Japan

[**] Term: 14 Years

[21] Appl. No.: 511,008

[22] Filed: Jul. 5, 1983

[30] Foreign Application Priority Data

Apr. 13, 1983 [JP] Japan 58 15320

[52] U.S. Cl. D10/38; D11/87

[58] Field of Search D10/30-32, D10/38, 39, 128; D11/87, 94; 368/281-283, 285, 276-278

[56] References Cited

U.S. PATENT DOCUMENTS

D. 76,424 9/1928 Schlacht D10/128 X
D. 160,000 9/1950 Moshel D10/38

D. 238,757 2/1976 Glarner D10/30
1,539,781 5/1925 Smythe D10/31

Primary Examiner—Louis S. Zarfaz
Attorney, Agent, or Firm—Cushman, Darby & Cushman

[57] CLAIM

The ornamental design for a watch case, as shown and described.

DESCRIPTION

FIG. 1 is a top plan view of a watch case showing my new design,
FIG. 2 is a right side elevational view thereof,
FIG. 3 is a left side elevational view thereof,
FIG. 4 is a rear elevational view thereof,
FIG. 5 is a front elevational view thereof,
FIG. 6 is bottom plan view thereof,
FIG. 7 is sectional view taken from line VII—VII in FIG. 1 and
FIG. 8 is top, left side and rear perspective view thereof.
The broken line showing of a watch band in FIG. 8 is for illustrative purposes only and forms no part of the claimed design.

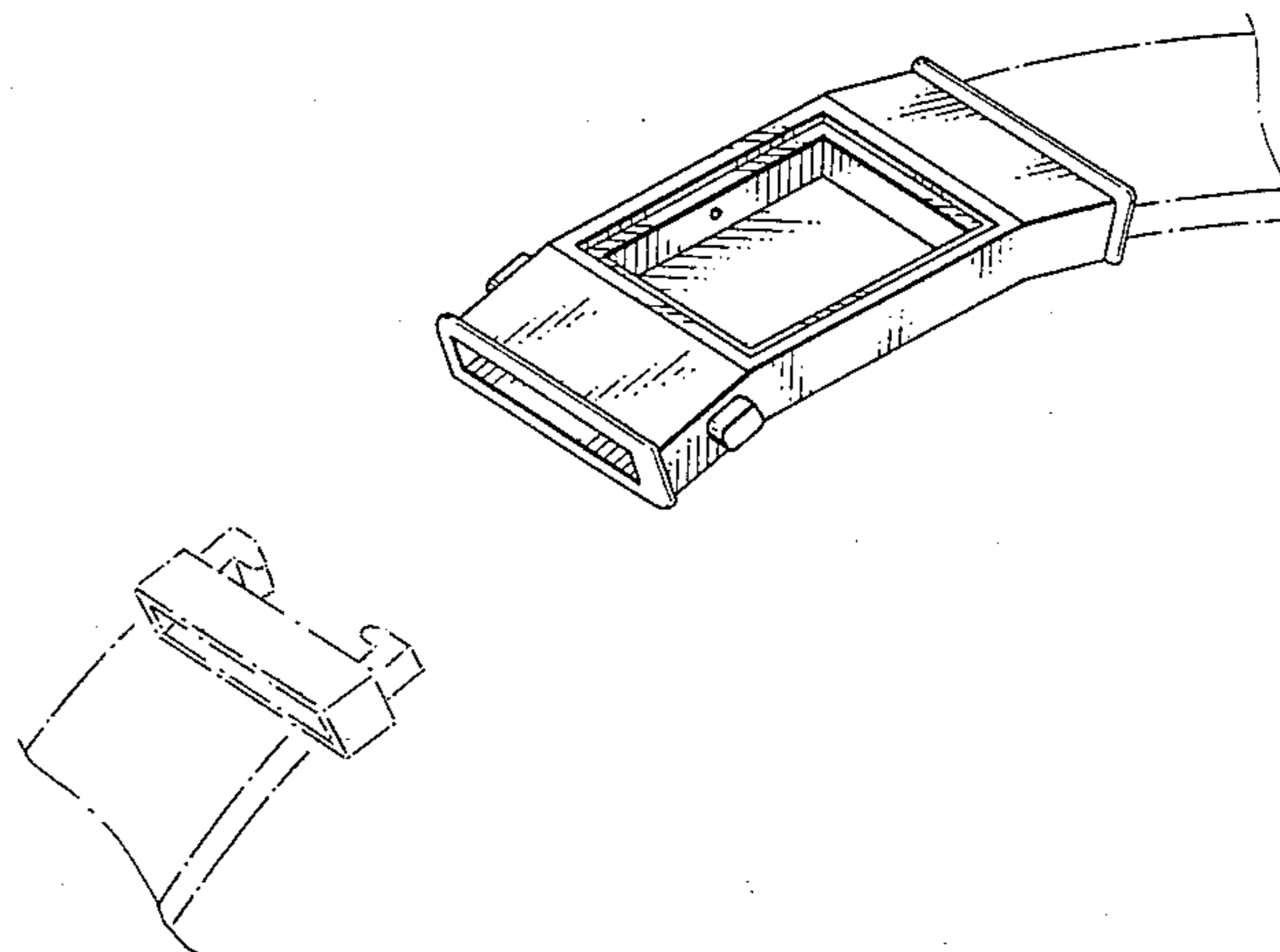

FIG. 4

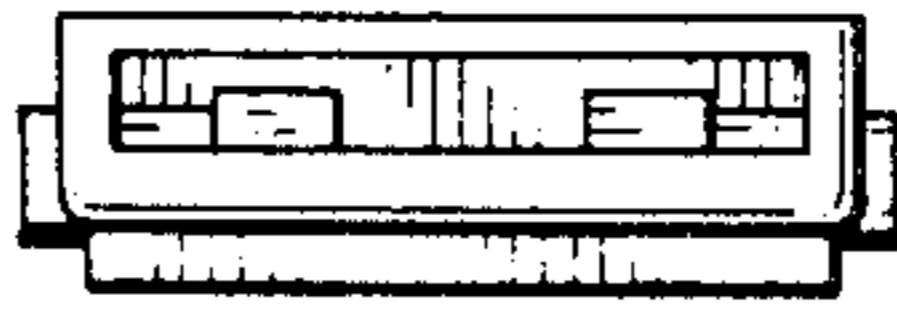

FIG. 3



FIG. 1

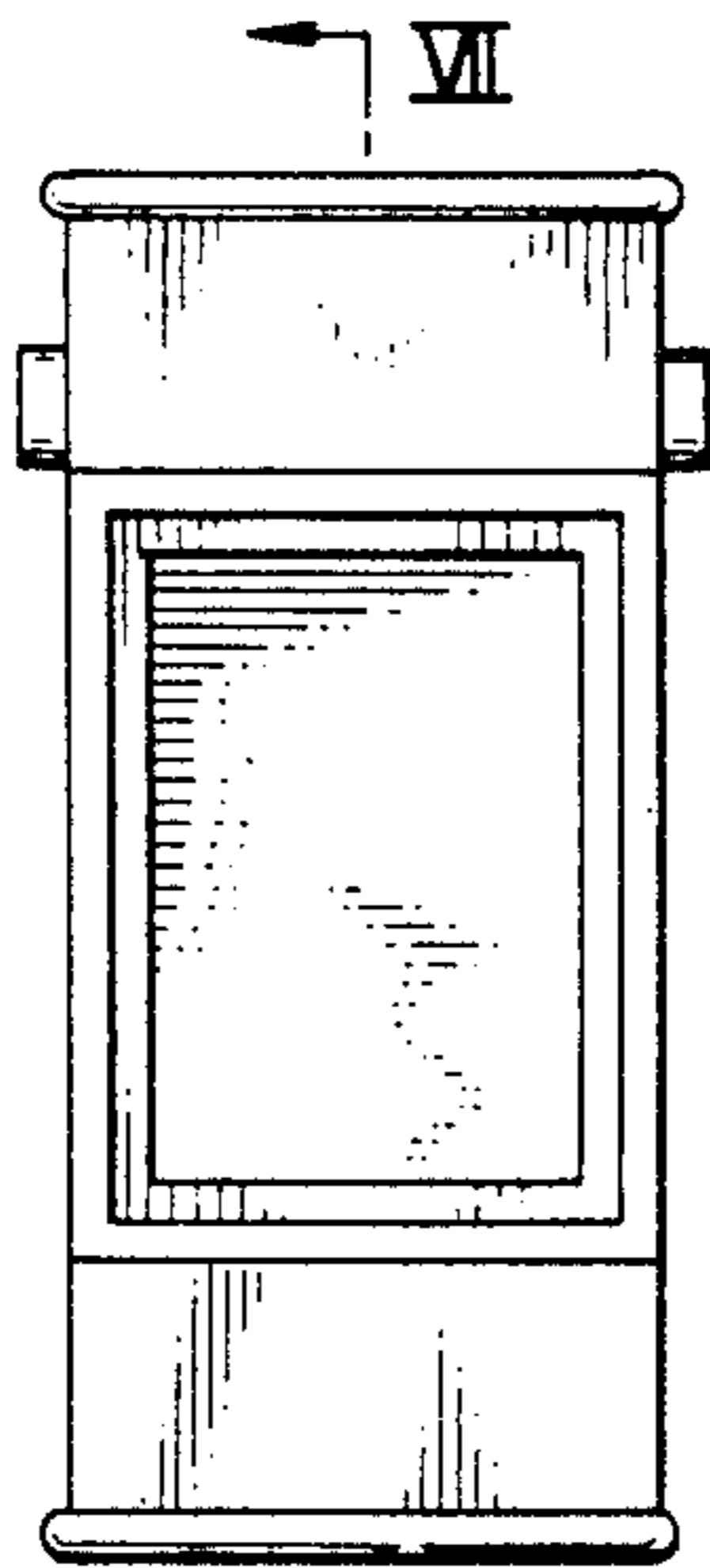

FIG. 2

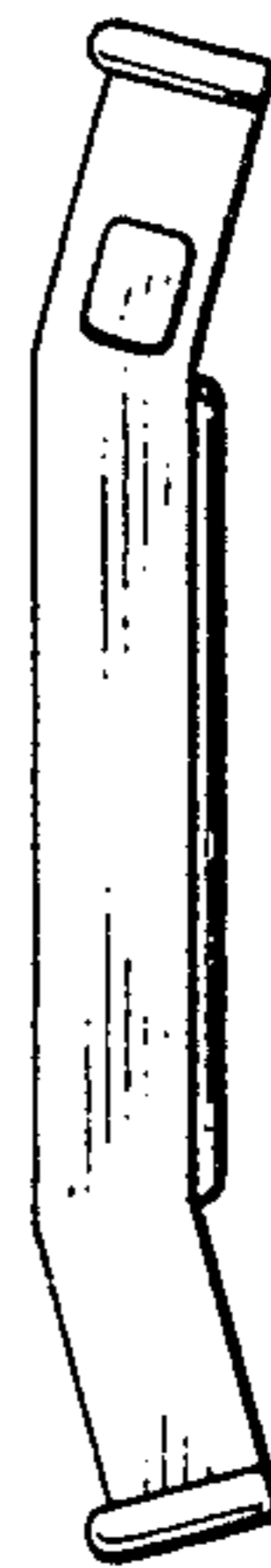

FIG. 5

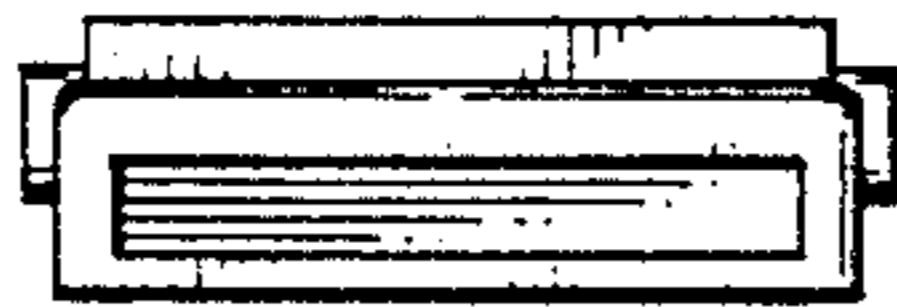

FIG. 6

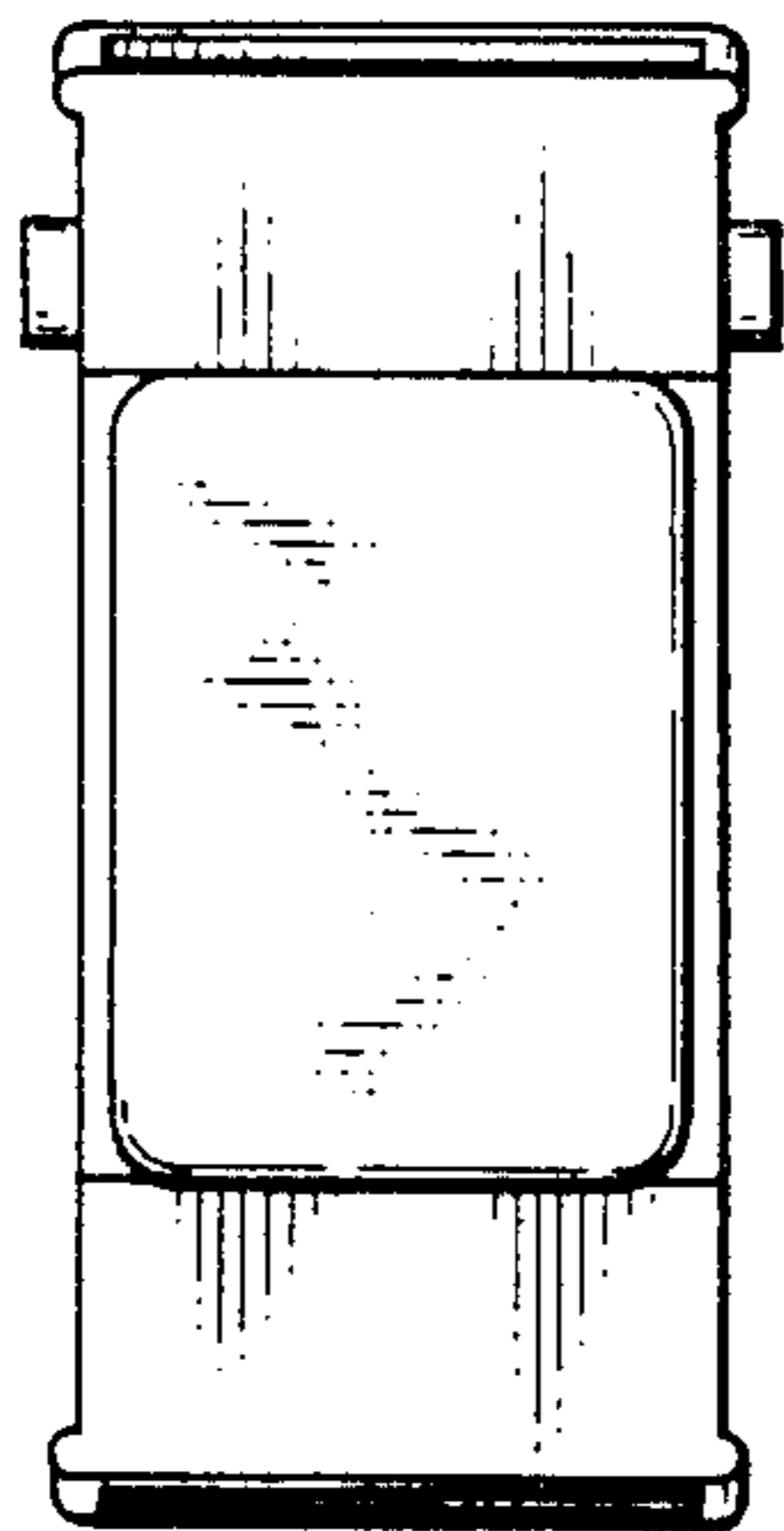

FIG. 7

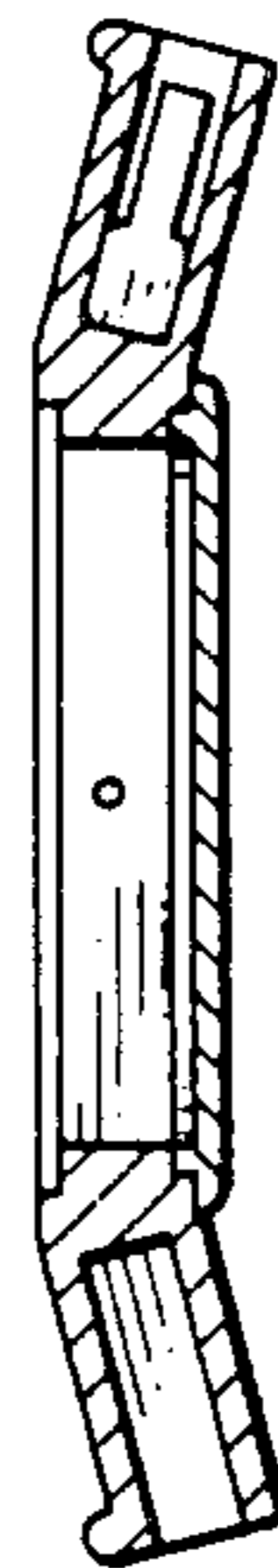

FIG. 8

