

[54] BOWL OR SIMILAR ARTICLE

[76] Inventor: Philippe J. Durand, Les Daneaux, Chemin de la Garenne, 62510 Arques, France

[**] Term: 14 Years

[21] Appl. No.: 608,495

[22] Filed: May 9, 1984

[52] U.S. Cl. D7/24; D7/28

[58] Field of Search D7/8, 24, 23, 26, 3, D7/1, 29-32, 28, 35

[56] References Cited

U.S. PATENT DOCUMENTS

D. 36,258	3/1903	Thiesen	D7/24
D. 41,413	5/1911	Anderson	D7/28
D. 104,836	6/1937	Ebeling	D7/24
D. 277,159	1/1985	Colquitt	D7/24

OTHER PUBLICATIONS

Tableware International, May 1974, p. 35, bottom right panel, Salad Plates With Crab and Fish Decorations.

Primary Examiner—Winifred E. Herrmann
Attorney, Agent, or Firm—Kimmel, Crowell & Weaver

[57] CLAIM

The ornamental design for a bowl or similar article, substantially as shown and described.

DESCRIPTION

FIG. 1 is a bottom plan view of a bowl or similar article showing my new design;

FIG. 2 is a top plan view thereof, with the pattern as seen through the interior wall having been mostly omitted for ease of illustration;

FIG. 3 is a side elevational view thereof, with the bowl being in an inverted position from the showing of FIG. 1, looking from the lower and left side of FIG. 1;

FIG. 4 is a side elevational view thereof, with the bowl being in an inverted position from the showing of FIG. 1, looking from the top of FIG. 1;

FIG. 5 is a side elevational view thereof, with the bowl being in an inverted position from the showing of FIG. 1, looking from the lower and right side of FIG. 1;

FIG. 6 is a sectional view, taken along the lines 6—6 of FIG. 2, with the pattern as seen through the interior wall having been left out for ease of illustration; and

FIG. 7 is a sectional view taken along the lines 7—7 of FIG. 2, with the pattern as seen through the interior wall having been left out for ease of illustration.

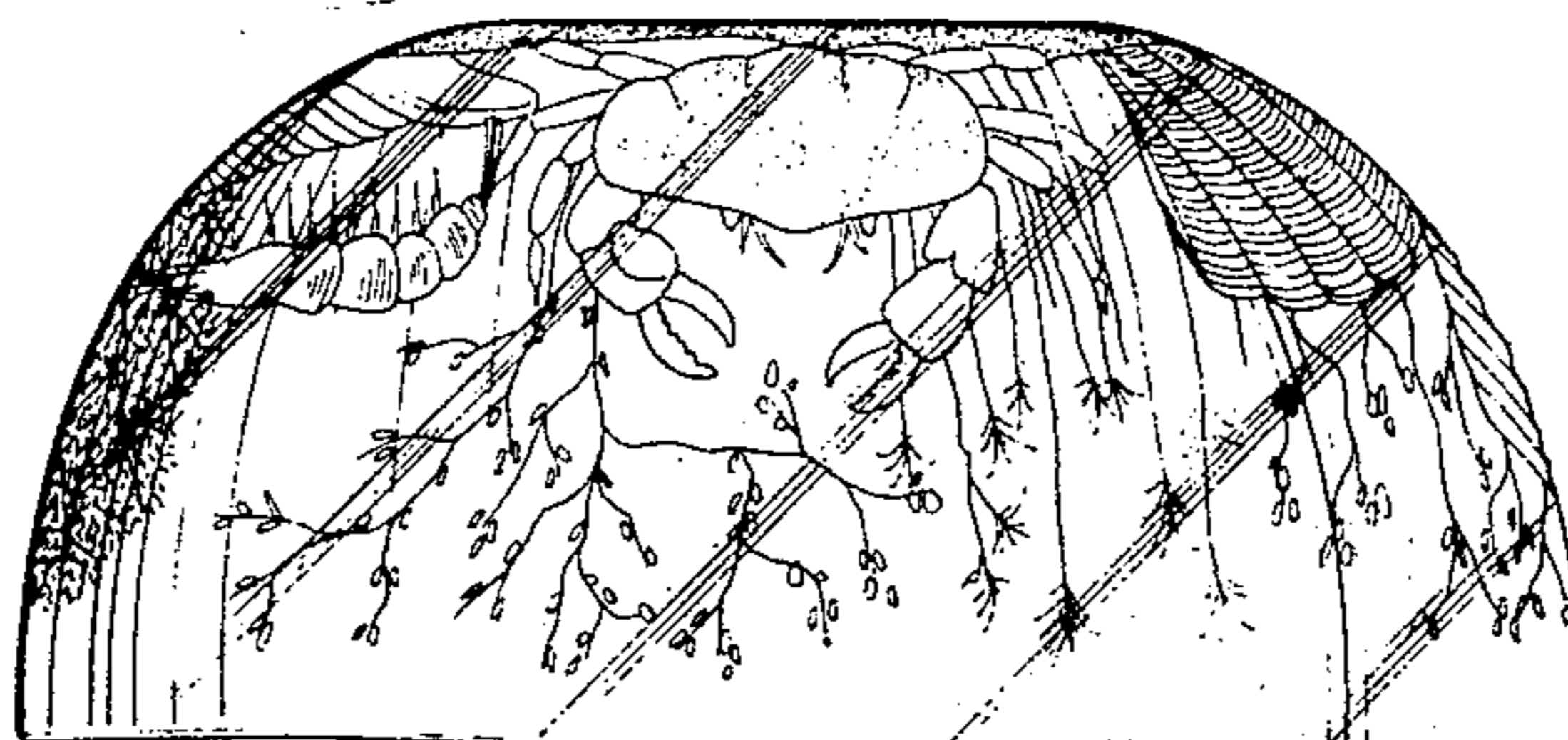
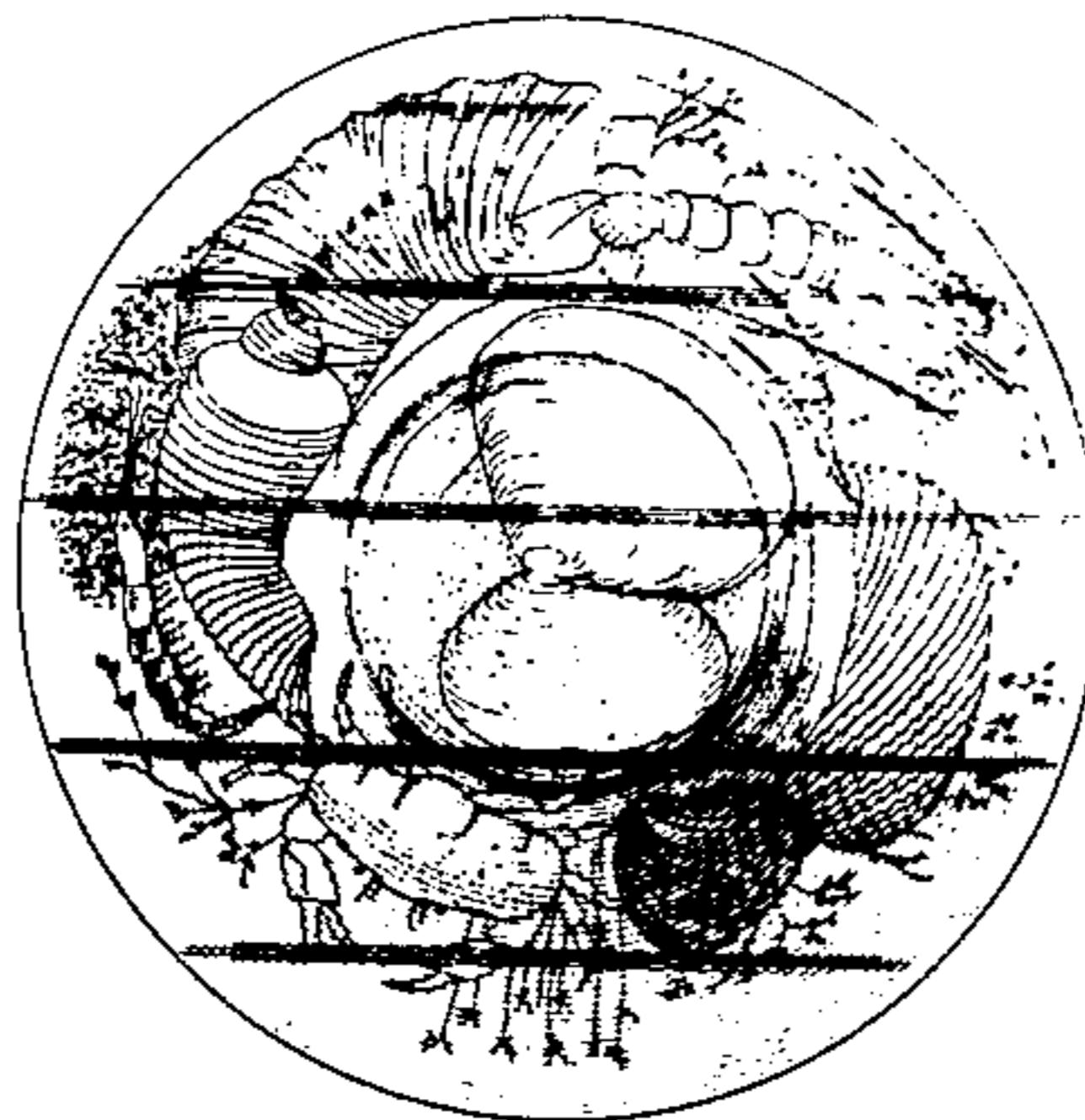
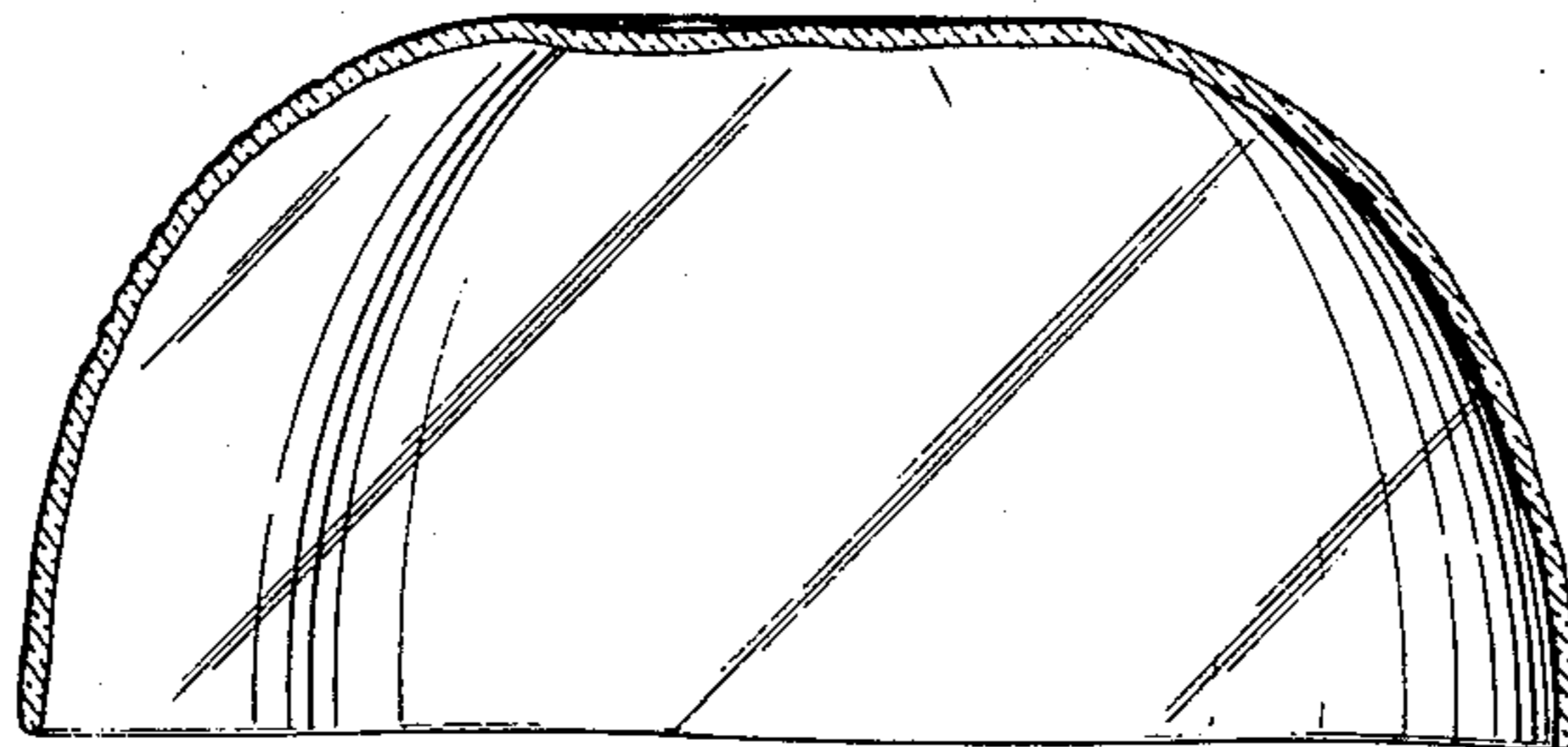

FIG. 1

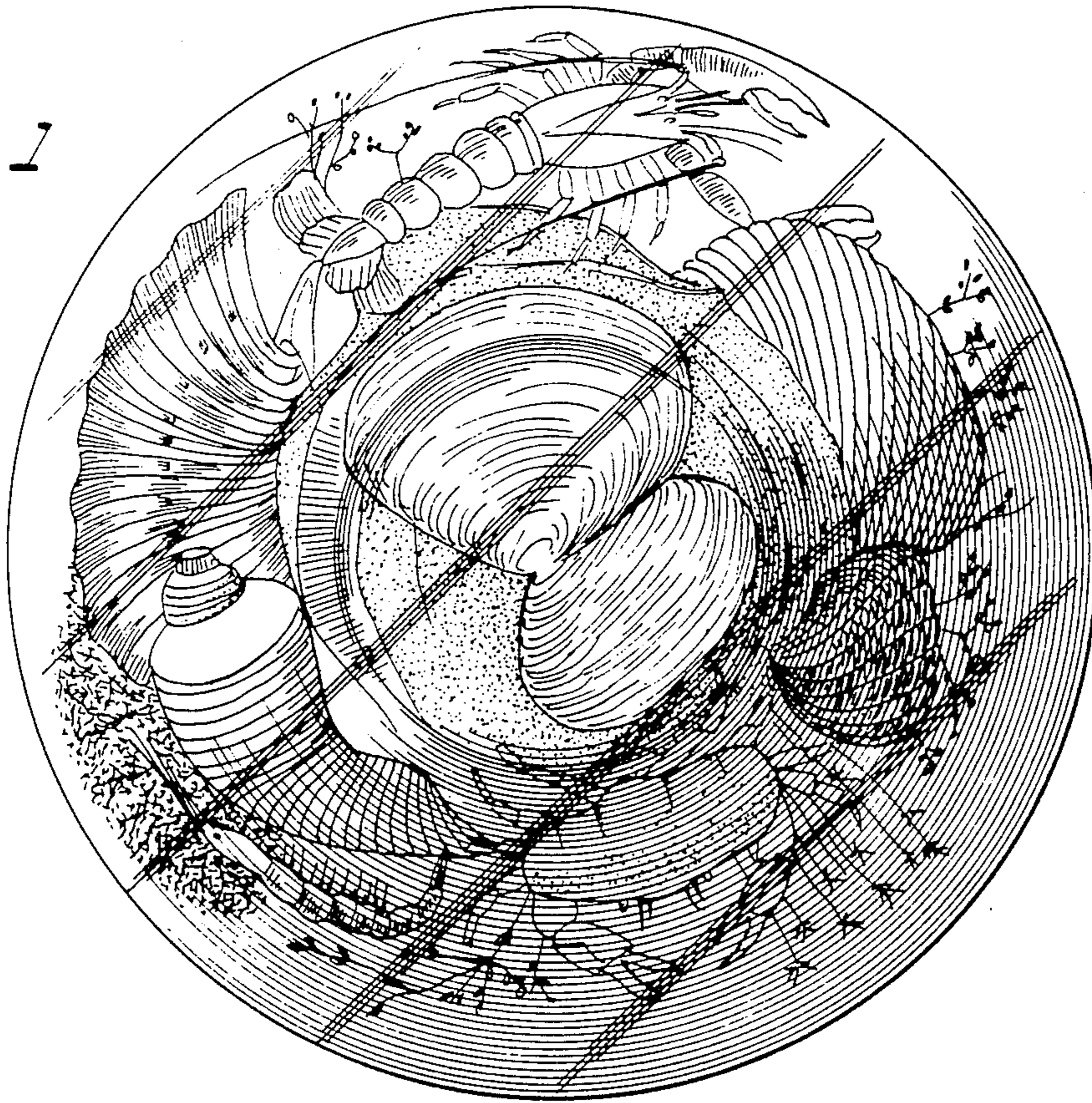

FIG. 2

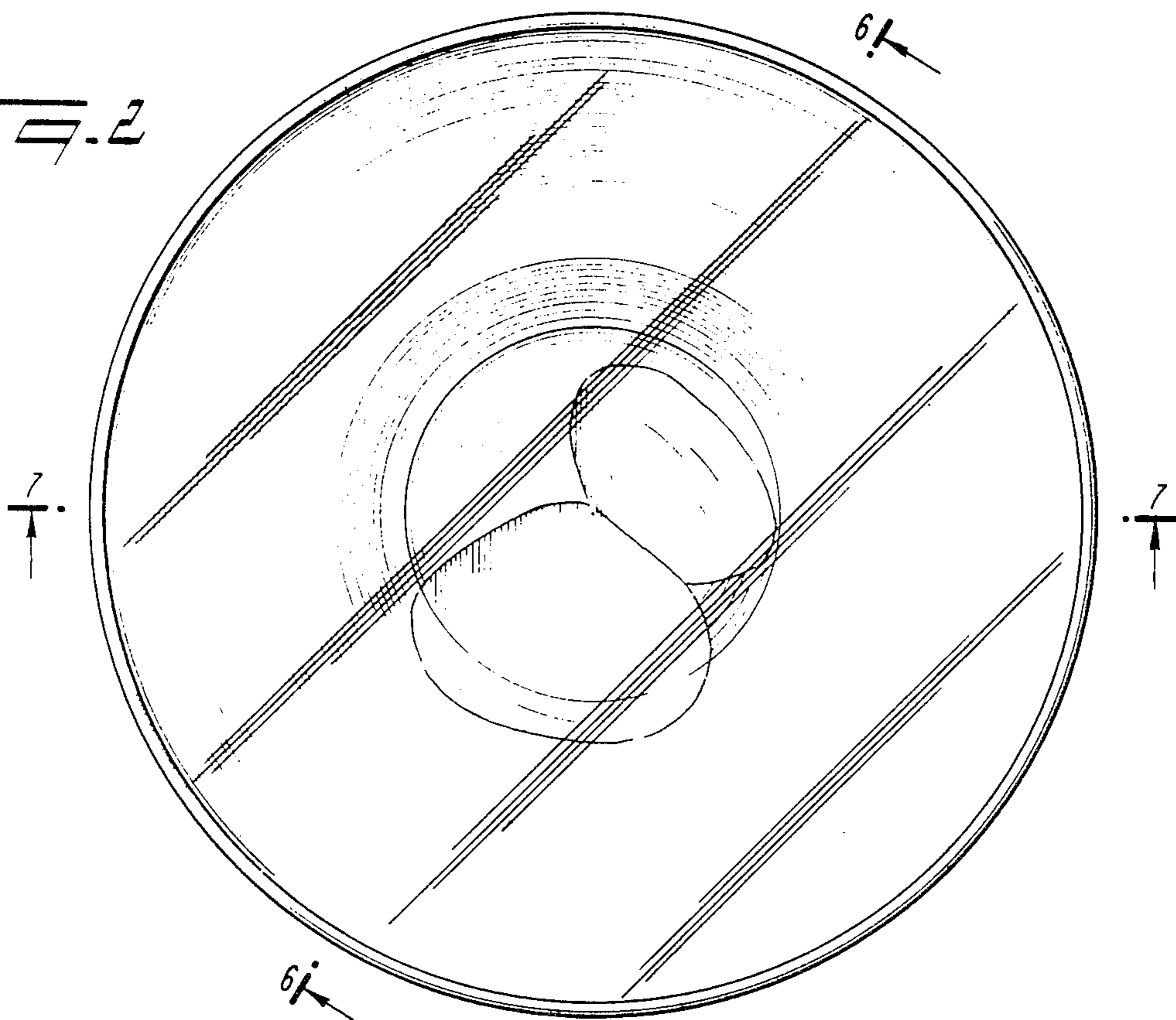

FIG. 3

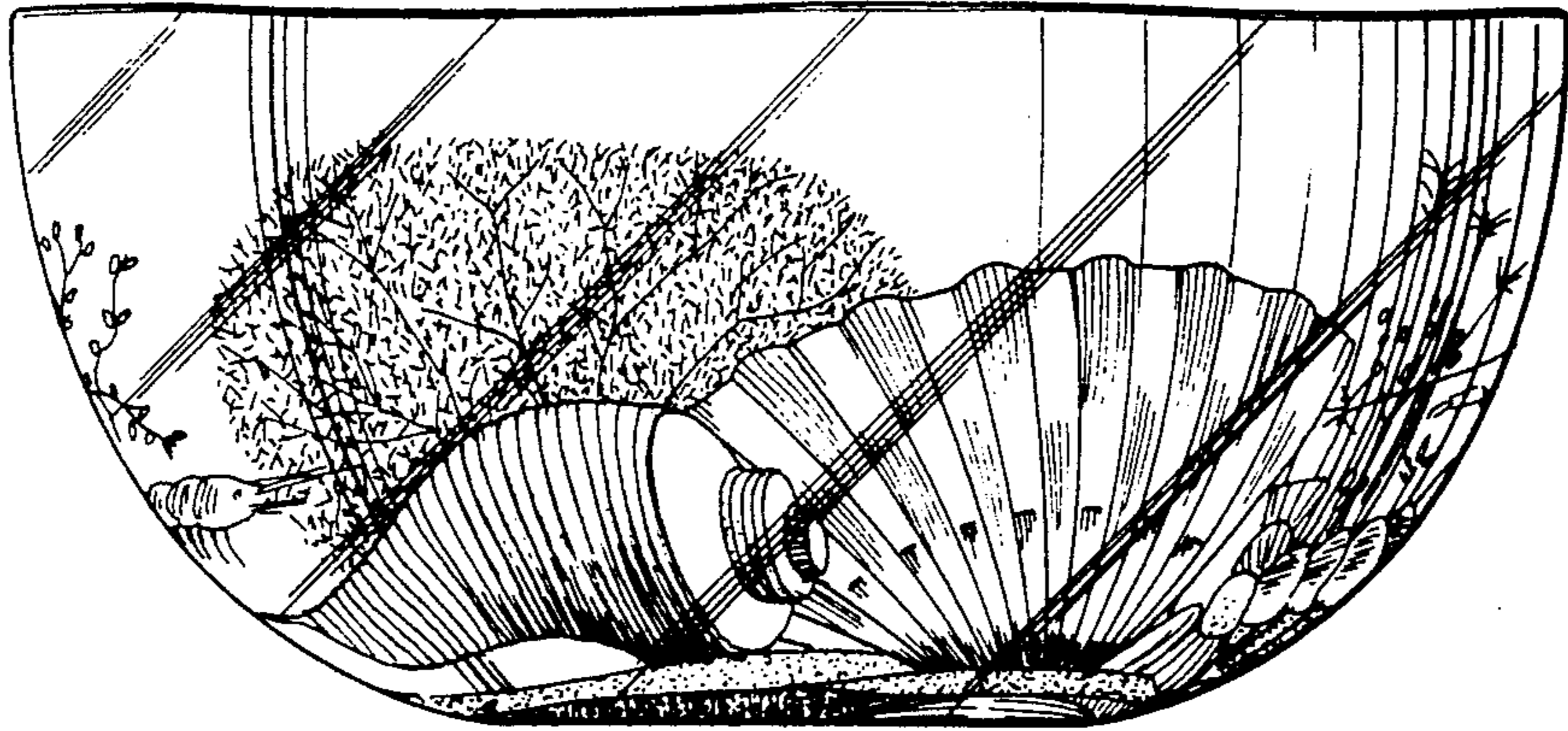

FIG. 4

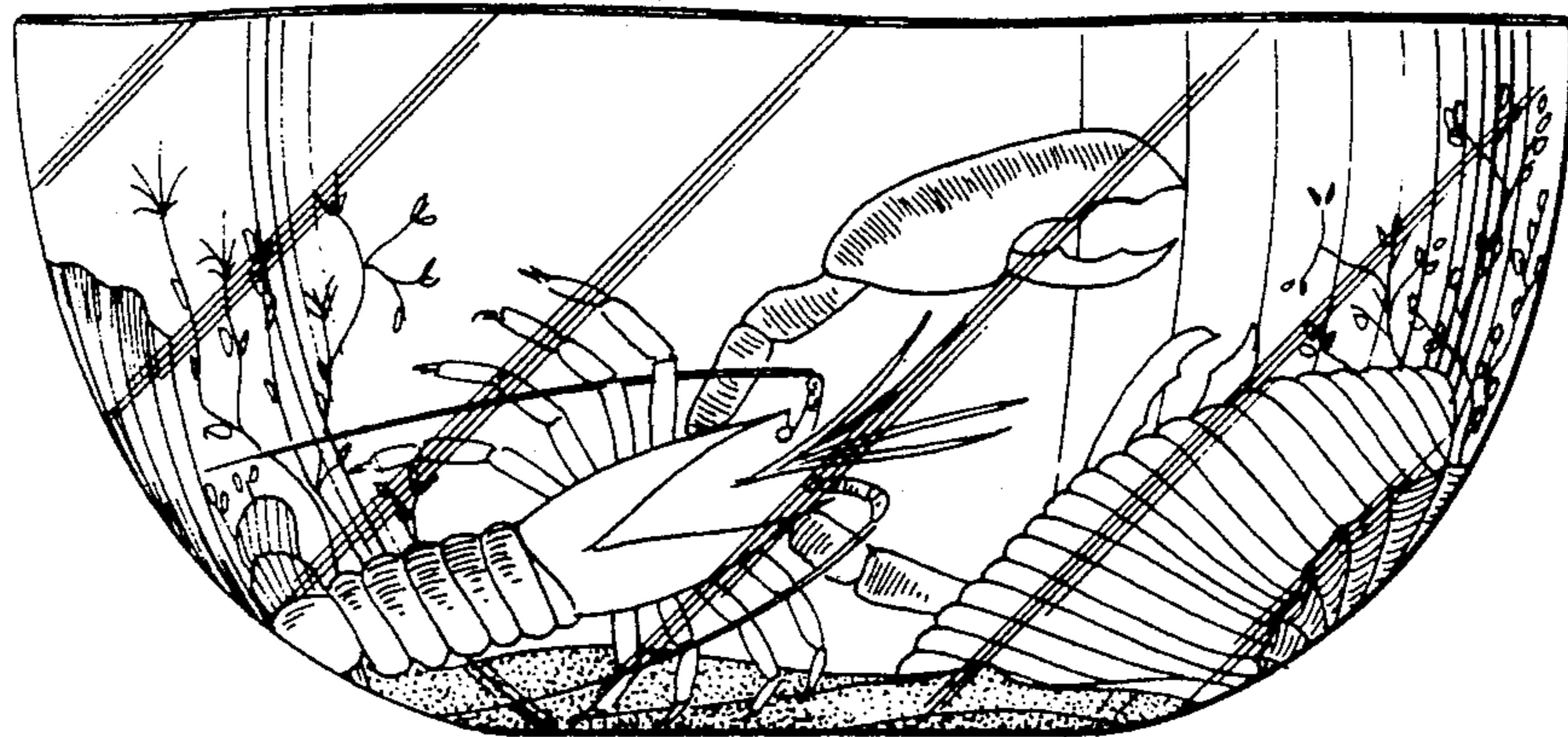

FIG. 5

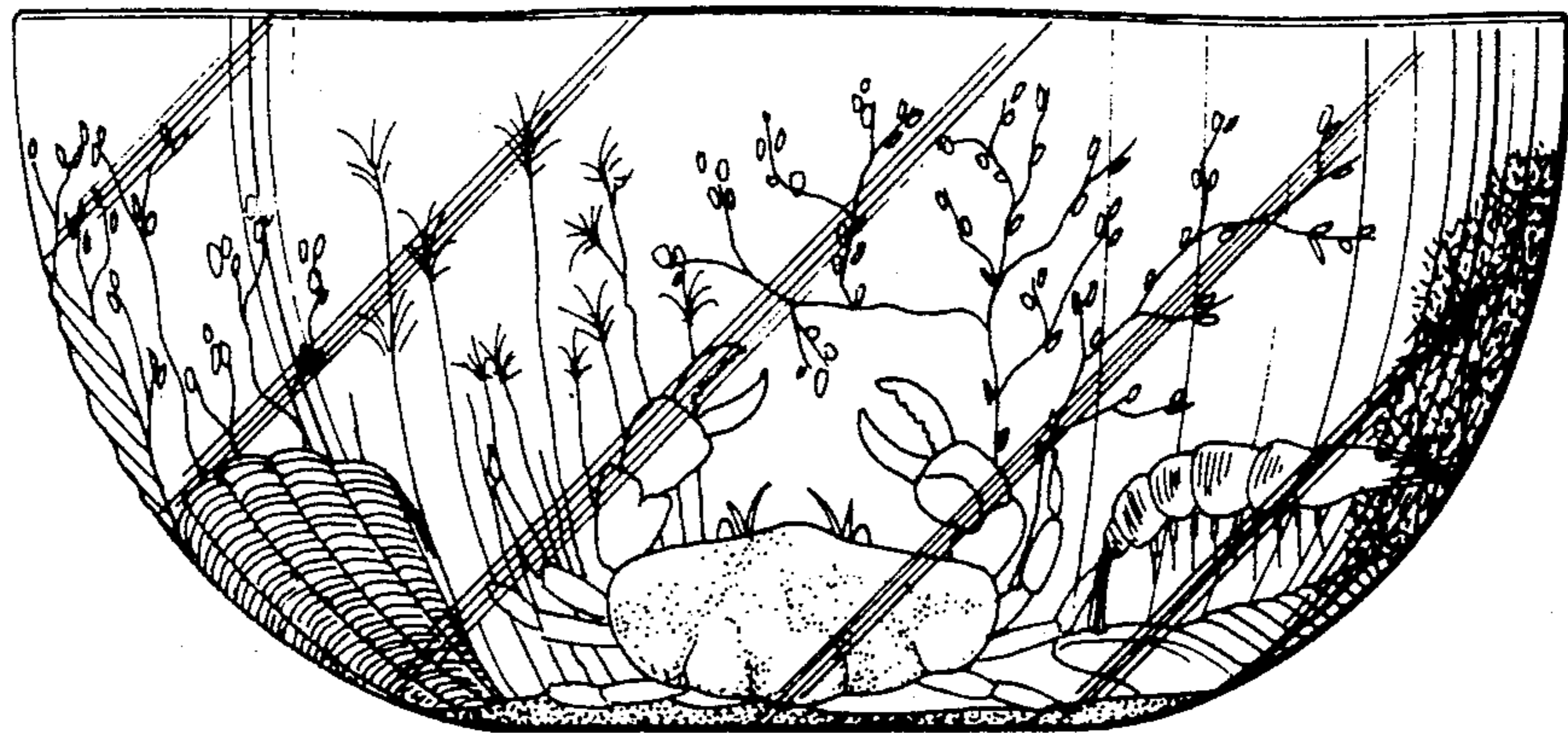

FIG. 6

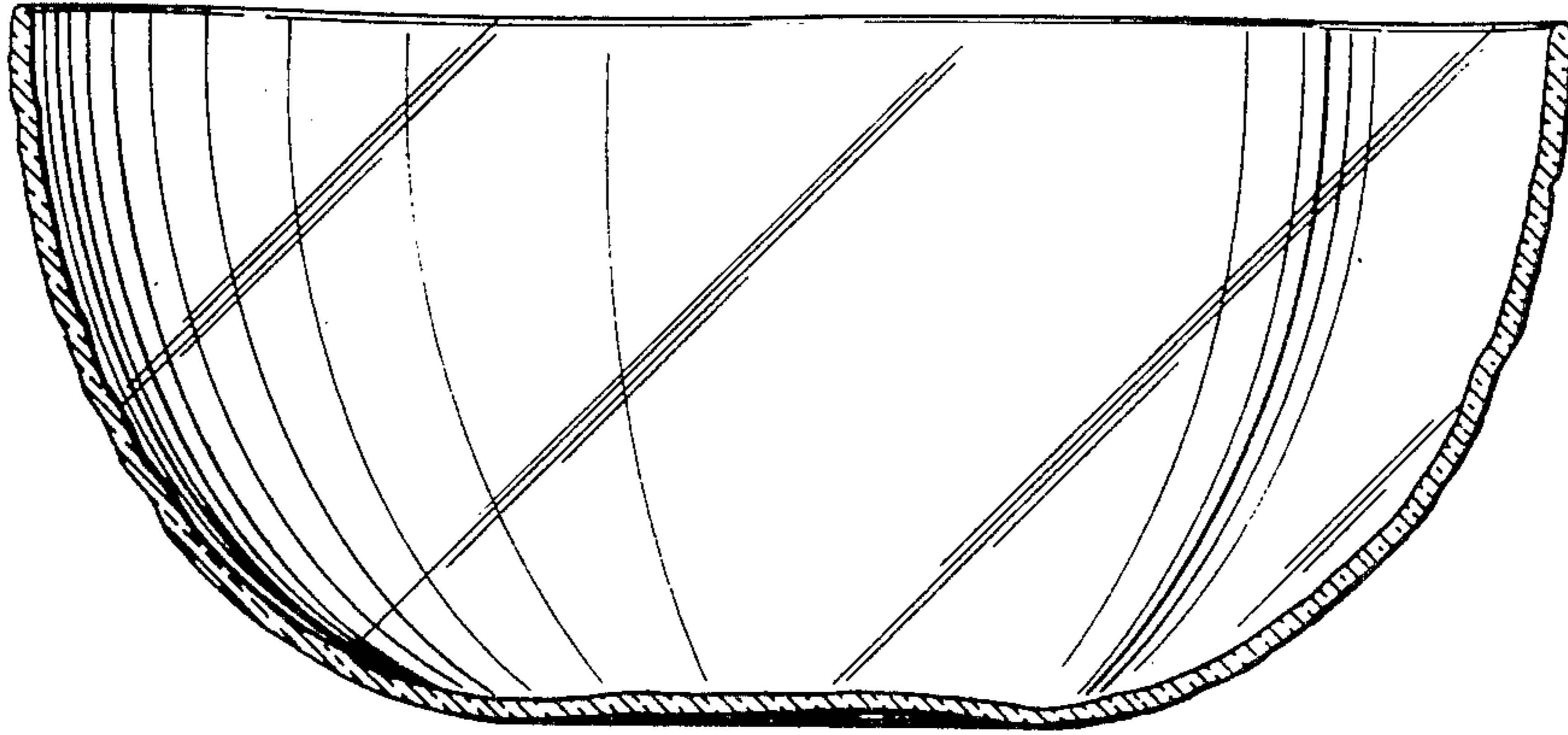

FIG. 7

