

[54] MAG CARD ACTIVATED COUPON LABEL DISPENSER

[76] Inventor: Floyd H. Haker, 6546 Linden La., Dallas, Tex. 75230

[**] Term: 14 Years

[21] Appl. No.: 506,066

[22] Filed: Jun. 20, 1983

[52] U.S. Cl. D20/2

[58] Field of Search D14/100-117; D20/2; 221/5, 2; 194/1 A, 1 O; 235/454, 462, 431, 449, 475

[56] References Cited

U.S. PATENT DOCUMENTS

D. 233,061 10/1974 Black et al. D20/2
3,526,308 9/1970 Thomas 221/5 X

4,225,056 9/1980 Flubacker 221/2

Primary Examiner—Susan J. Lucas
Attorney, Agent, or Firm—Warren H. Kintzinger

[57] CLAIM

The ornamental design for a mag card activated coupon label dispenser, substantially as shown and described.

DESCRIPTION

FIG. 1 is a front, left side perspective view of the mag card activated coupon label dispenser showing my new design;

FIGS. 2 and 3 are respectively left and right side elevation views thereof on a reduced scale;

FIGS. 4 and 5 are respectively front and rear elevation views thereof on a reduced scale; and

FIGS. 6 and 7 are respectively top and bottom plan views thereof on a reduced scale.

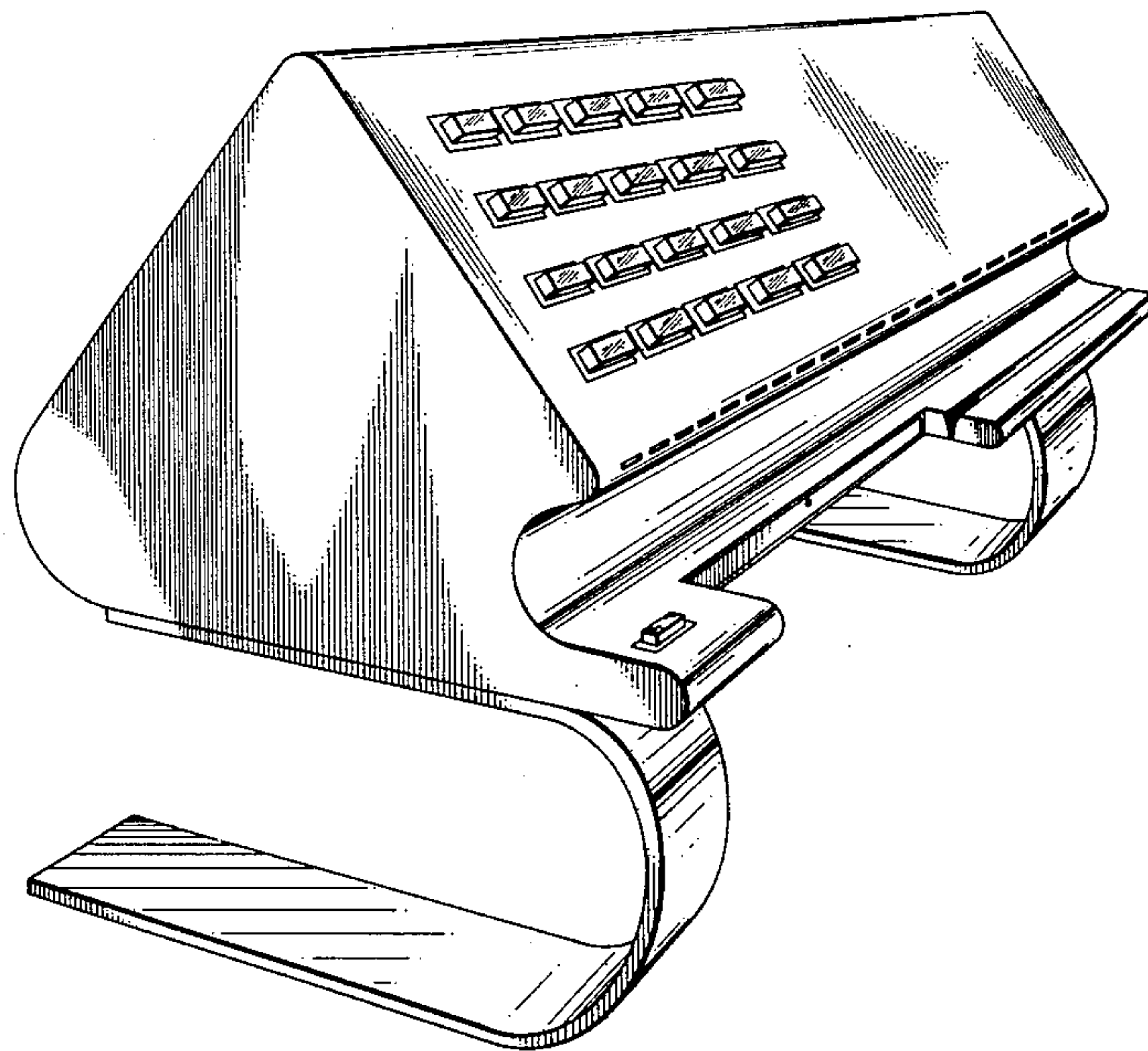

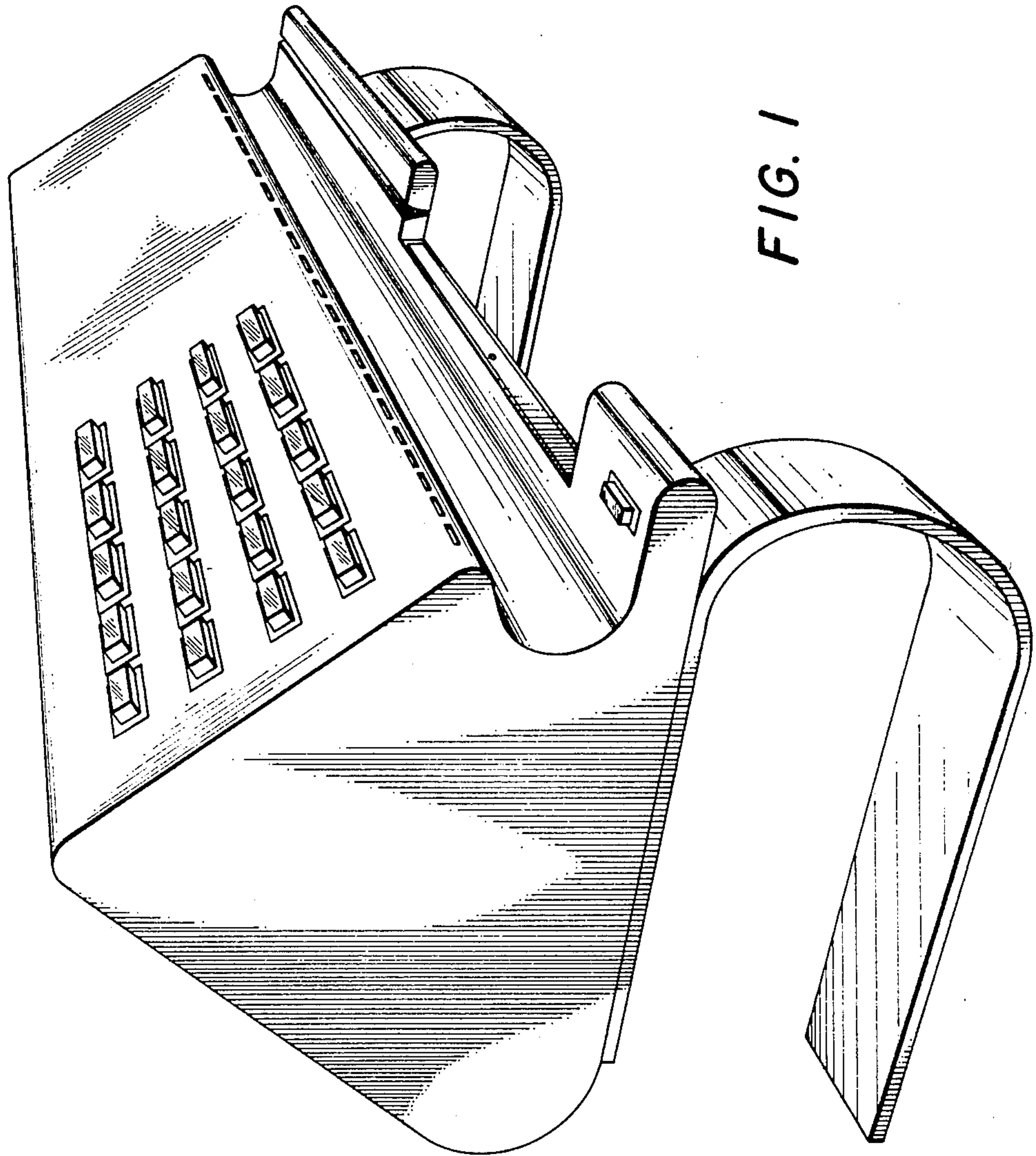

FIG. 1

FIG. 2

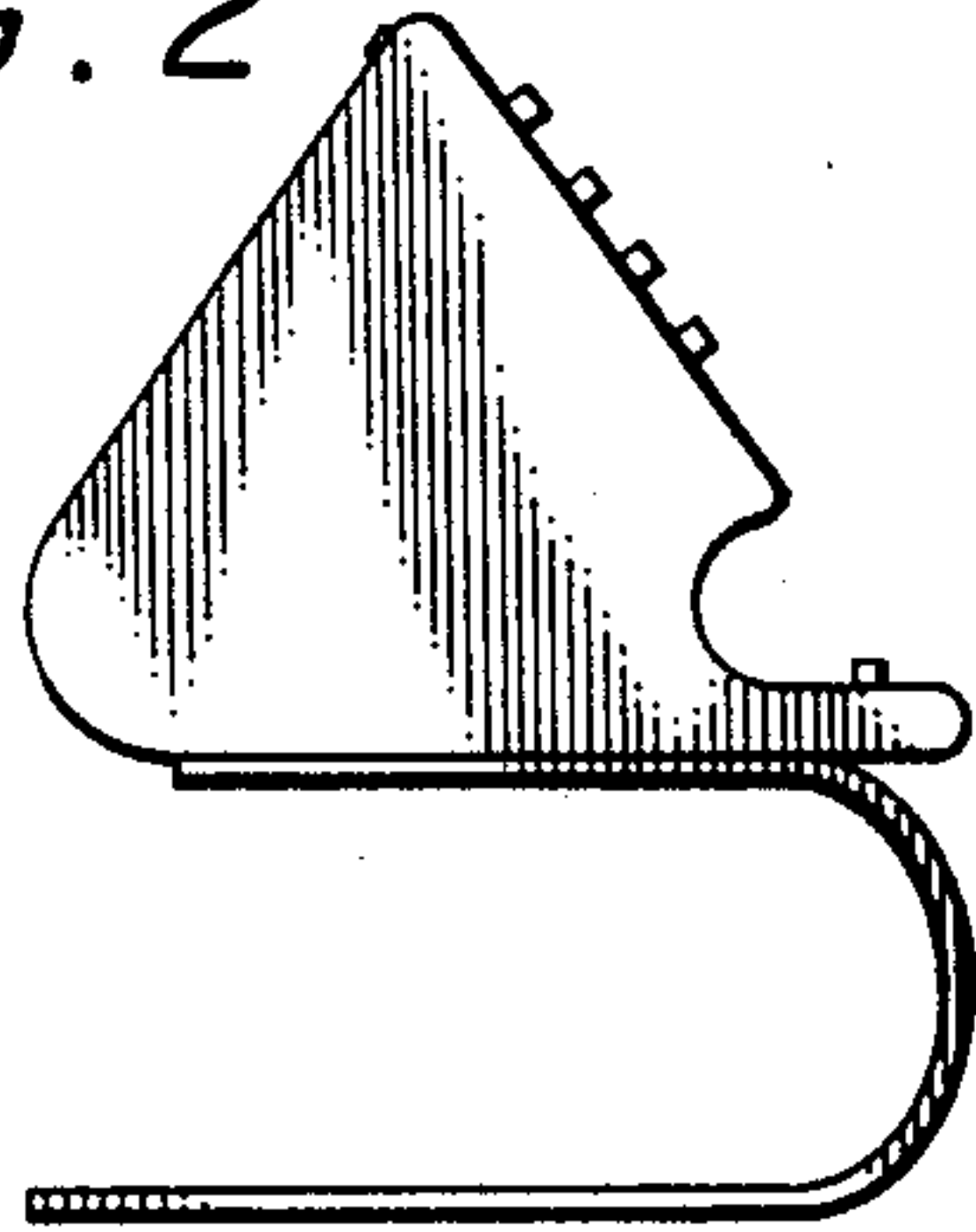

FIG. 3

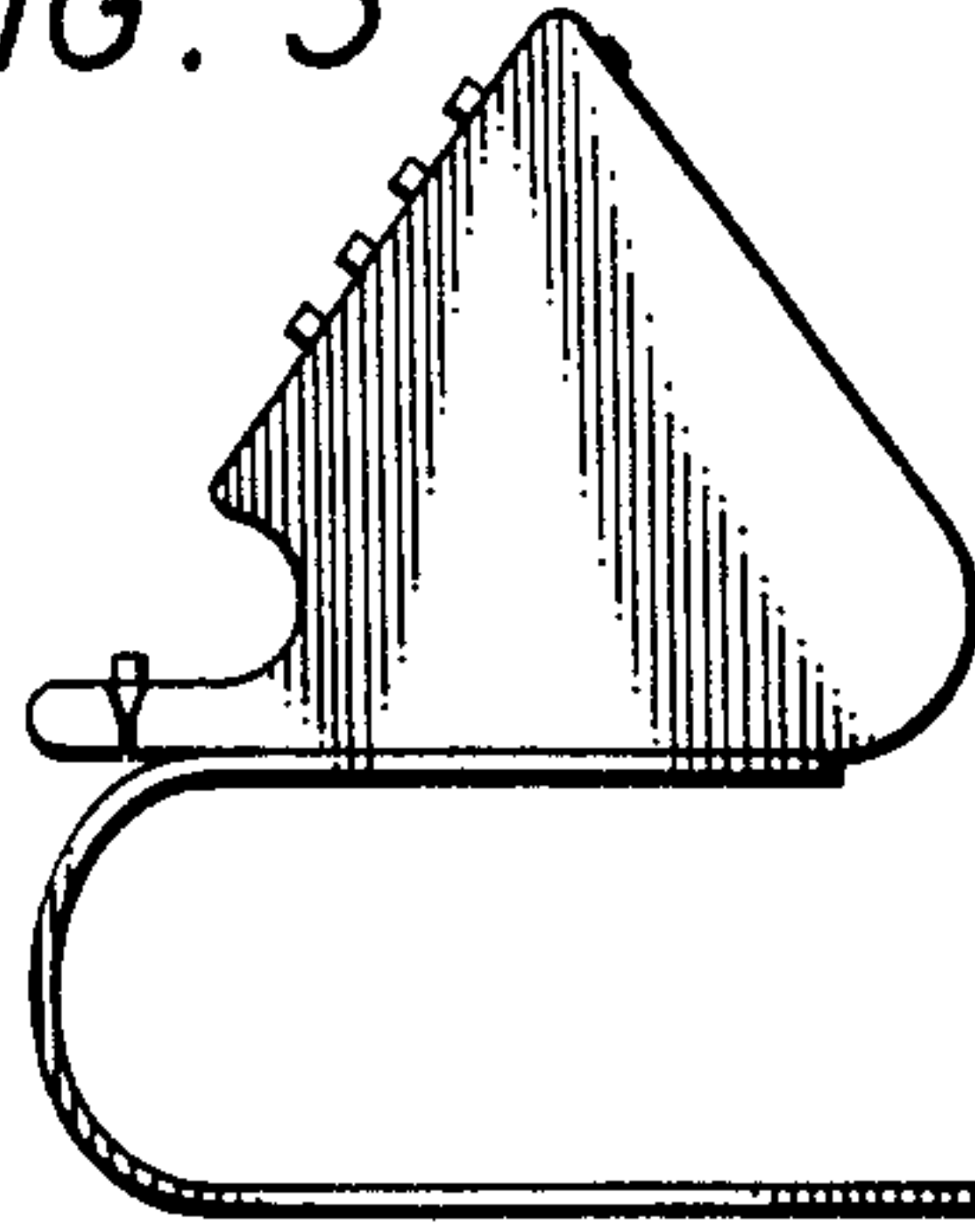

FIG. 4

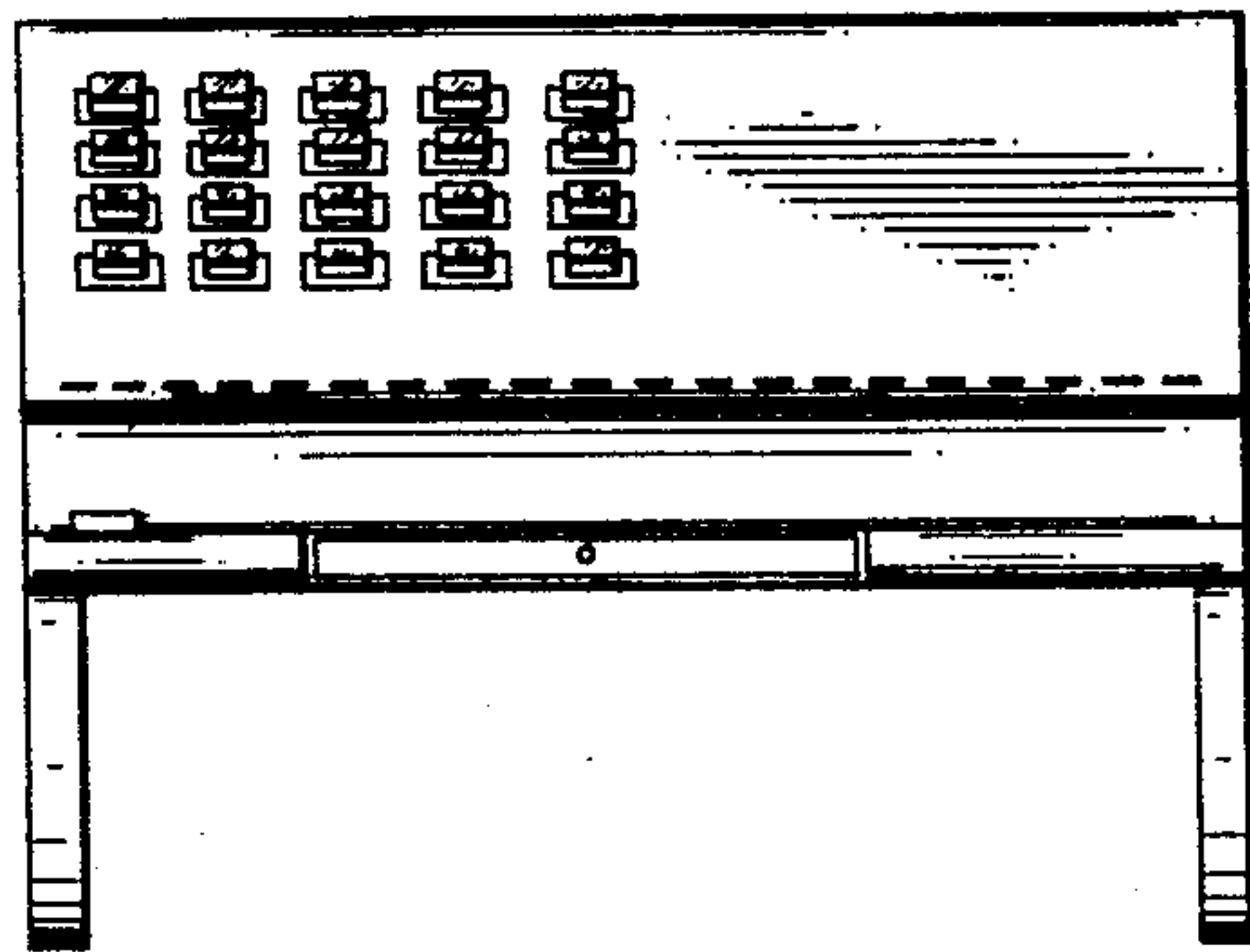

FIG. 5

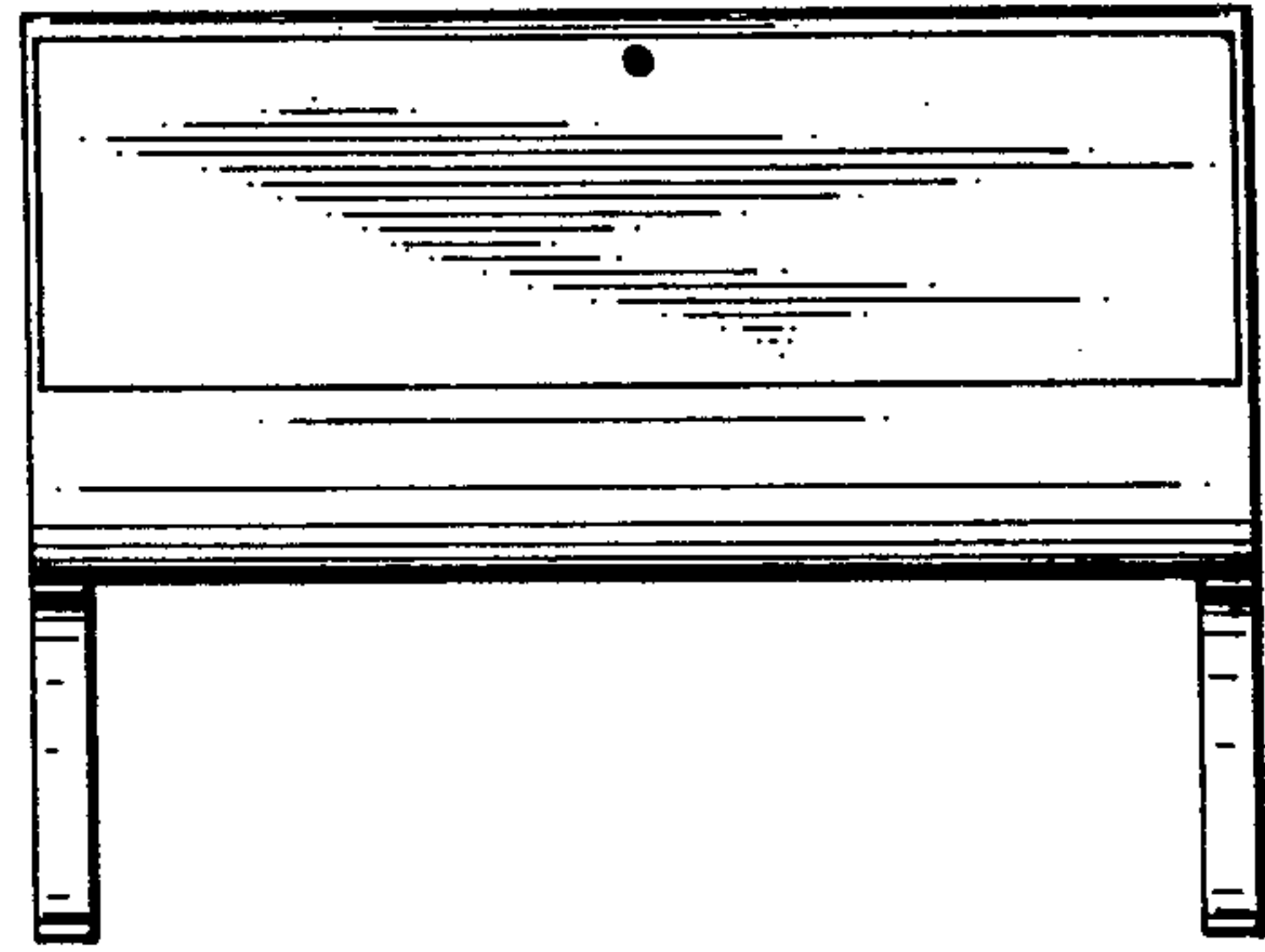

FIG. 6

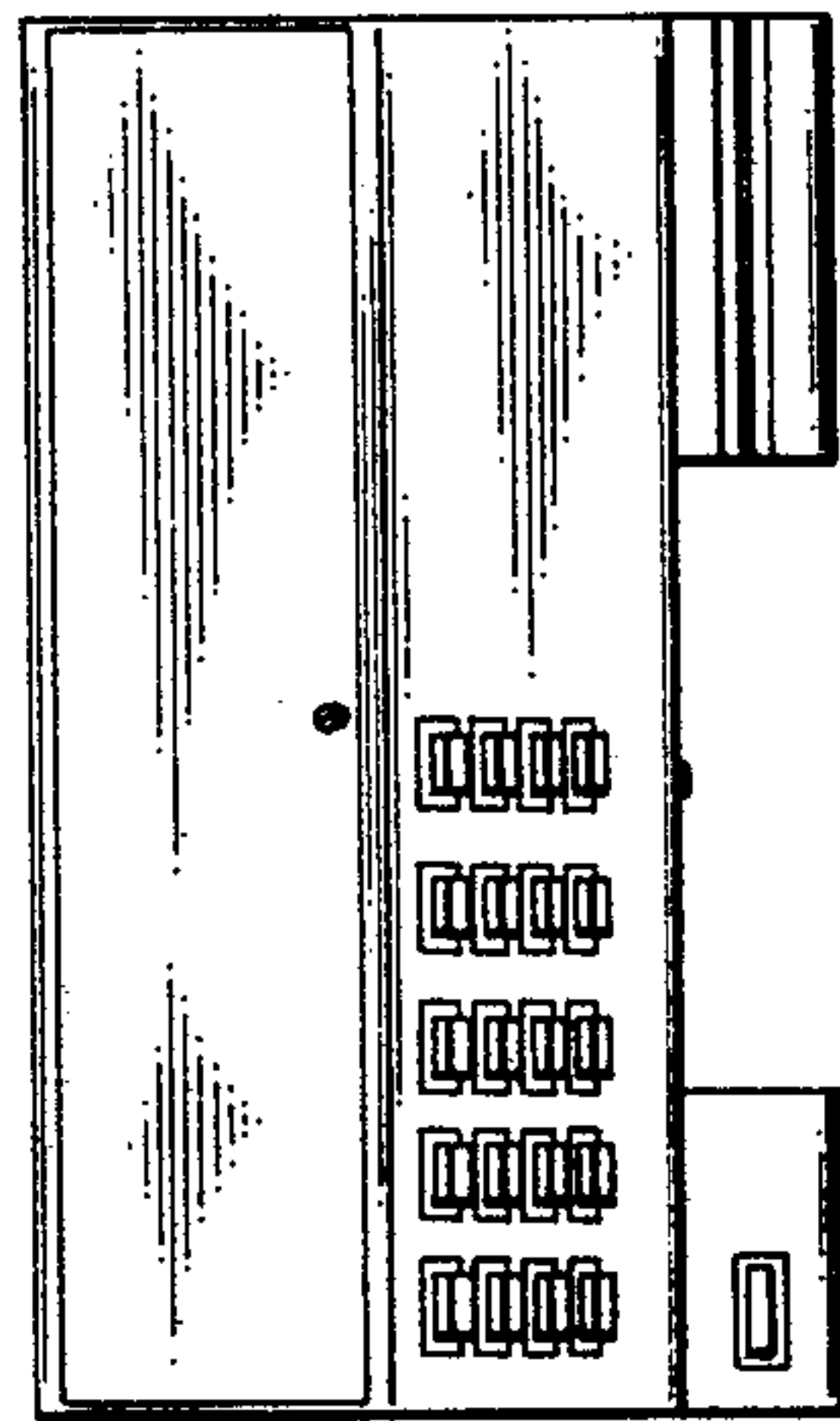

FIG. 7

