

- [54] CHILD RESTRAINING HARNESS FOR A SHOPPING CART
- [76] Inventors: Vickey A. Roney; Michael D. Roney; both of 1330 Greenlake Dr., Cardiff, Calif. 92007
- [\*\*] Term: 14 Years
- [21] Appl. No.: 476,924
- [22] Filed: Mar. 21, 1983
- [52] U.S. Cl. .... D2/27; D34/27
- [58] Field of Search ..... D34/27; D2/27; 2/44, 2/45; 280/33.99 A, 33.99 B, 801, 808, 751; 297/468, 479, 483-488

- [56] **References Cited**
- U.S. PATENT DOCUMENTS**
- 2,413,395 12/1946 Ware ..... D2/27
- 3,612,605 10/1971 Posey, Jr. .... 297/485
- 4,376,551 3/1983 Cone ..... 297/484

Primary Examiner—James M. Gandy  
Attorney, Agent, or Firm—David J. Harshman

[57] **CLAIM**

The ornamental design for a child restraining for a shopping cart, as shown and described.

**DESCRIPTION**

FIG. 1 is a top plan view of a child restraining for shopping cart showing our new design in unbled condition;

FIG. 2 is an enlarged top plan view of the pad thereof with the shoulder straps broken away remainder of the harness omitted for convenient illustration;

FIG. 3 is a bottom plan view of FIG. 2;

FIG. 4 is an end elevation view of FIG. 3;

FIG. 5 is a front perspective view thereof in assembled condition; and

FIG. 6 is a rear perspective view of FIG. 5.

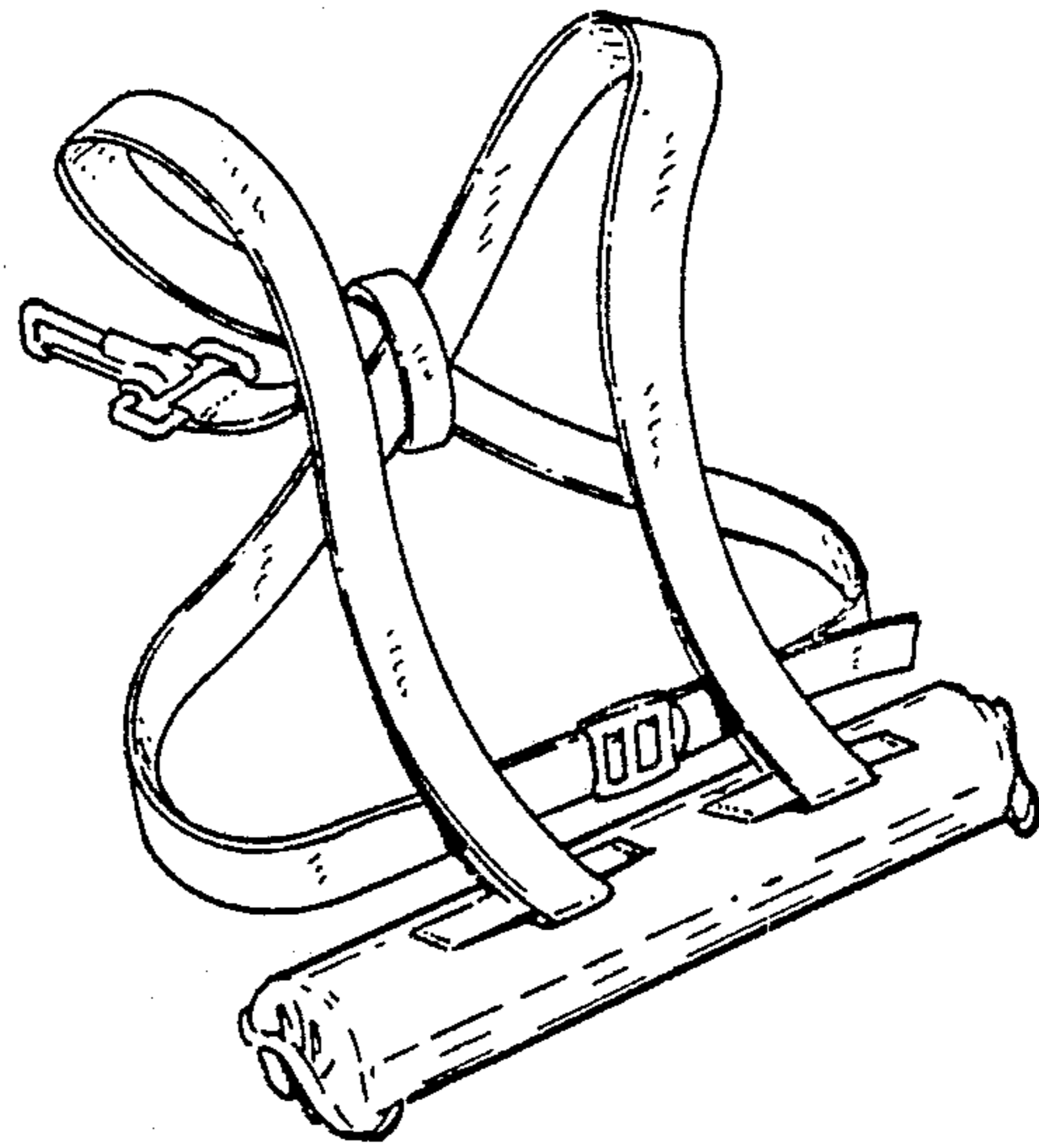

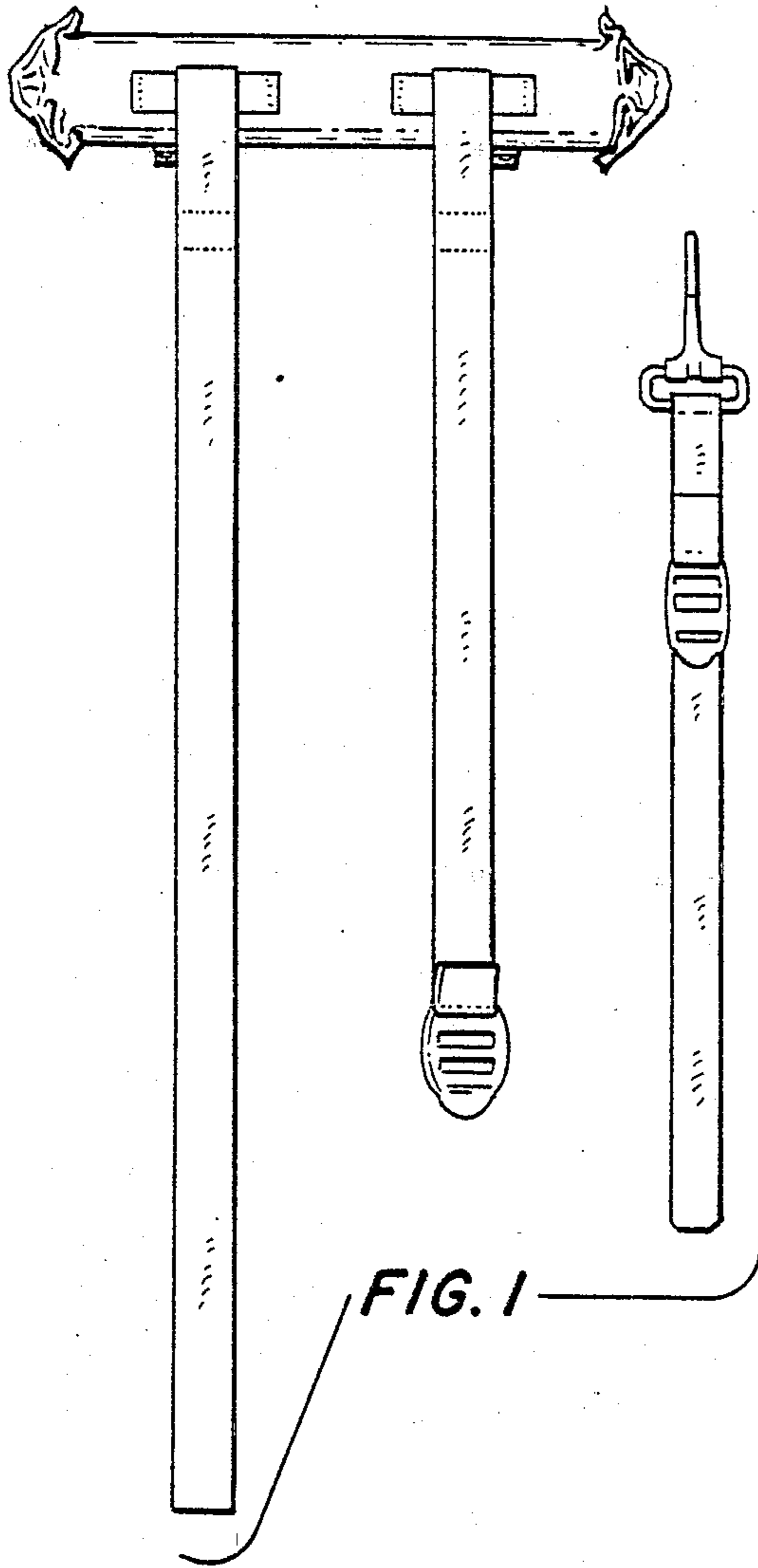

FIG. 1

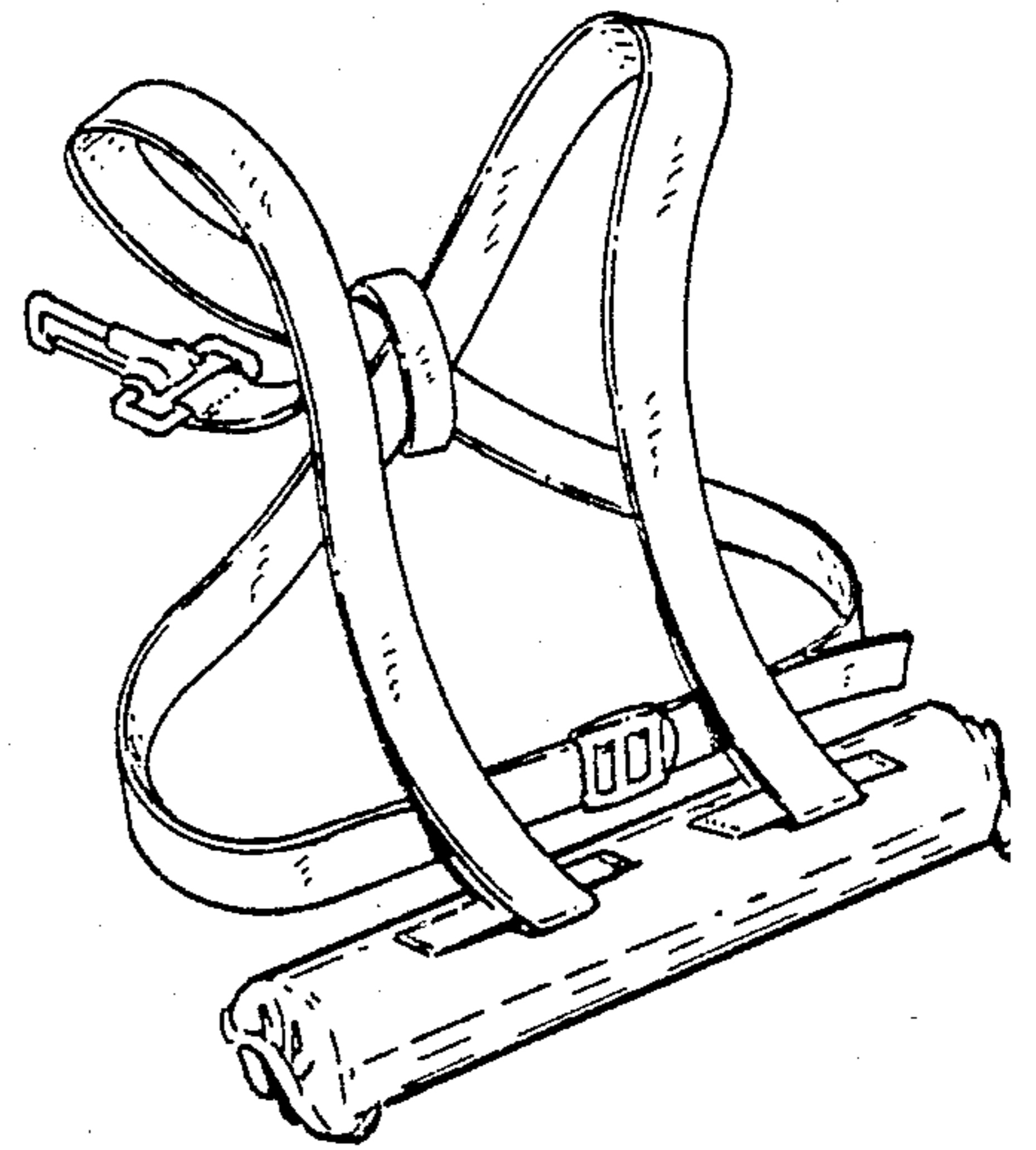

FIG. 5

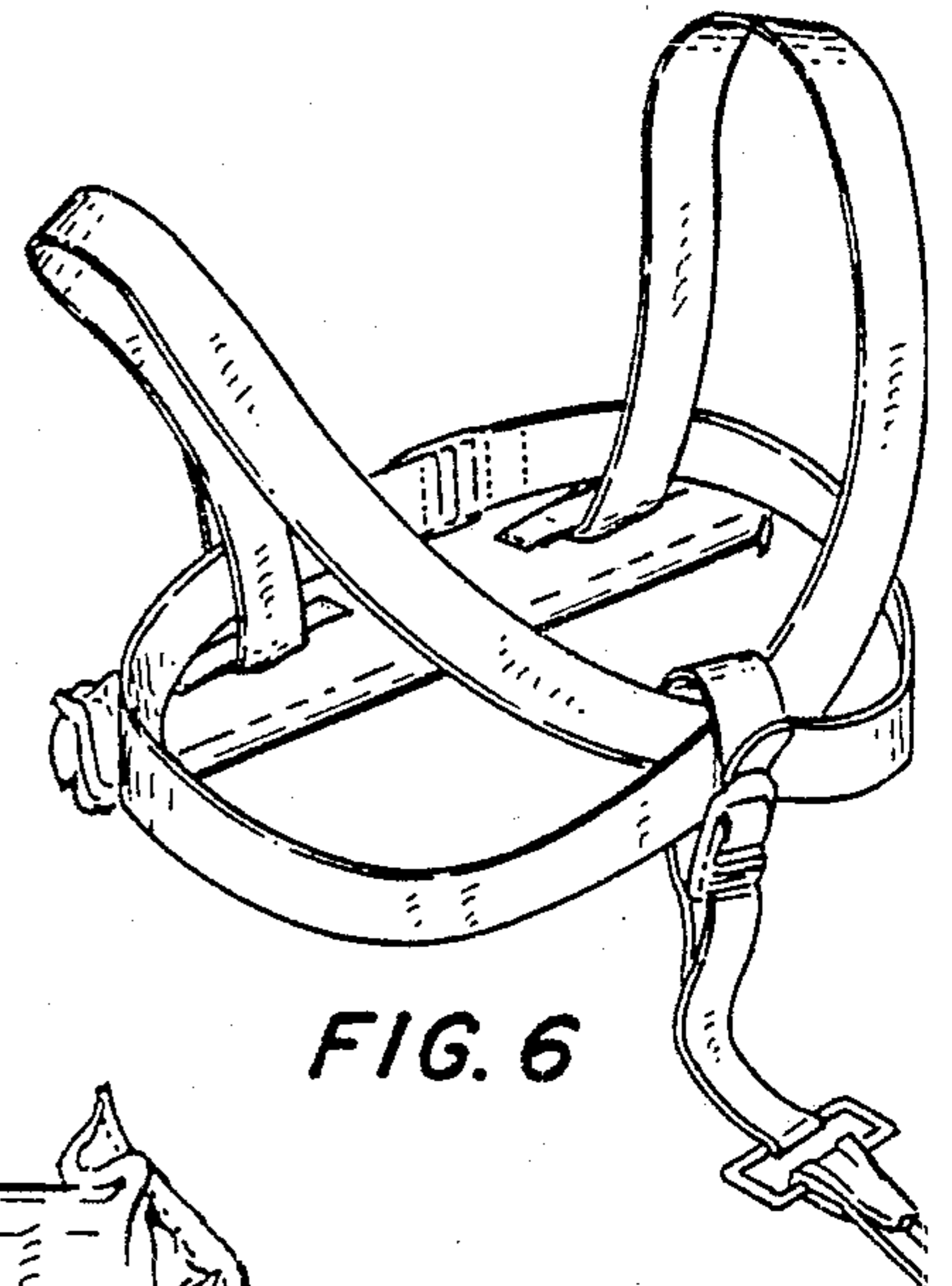

FIG. 6

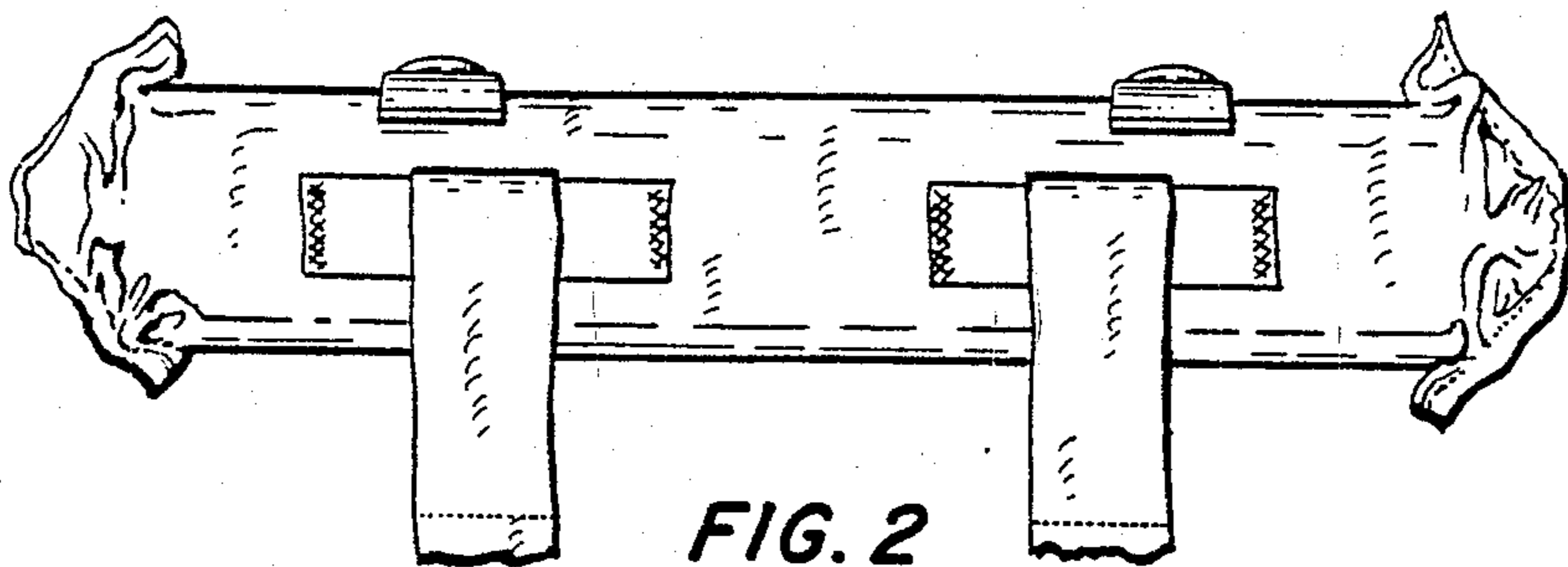

FIG. 2

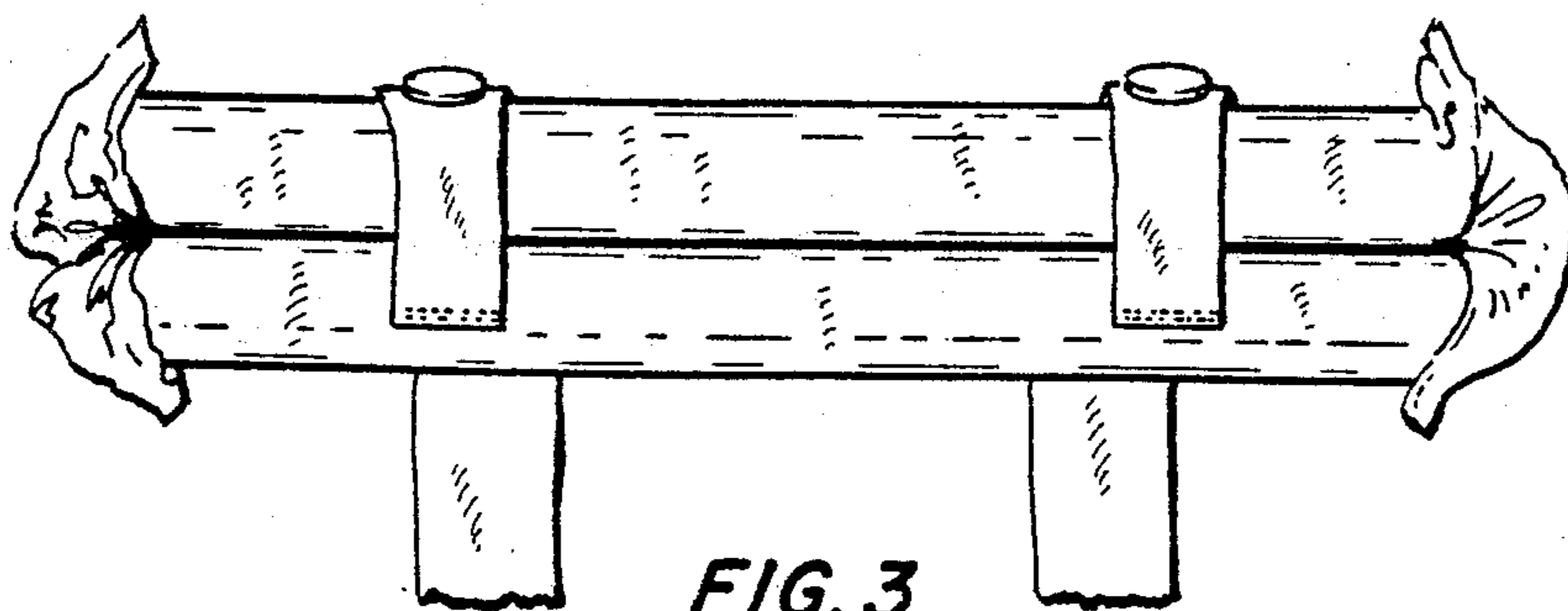

FIG. 3

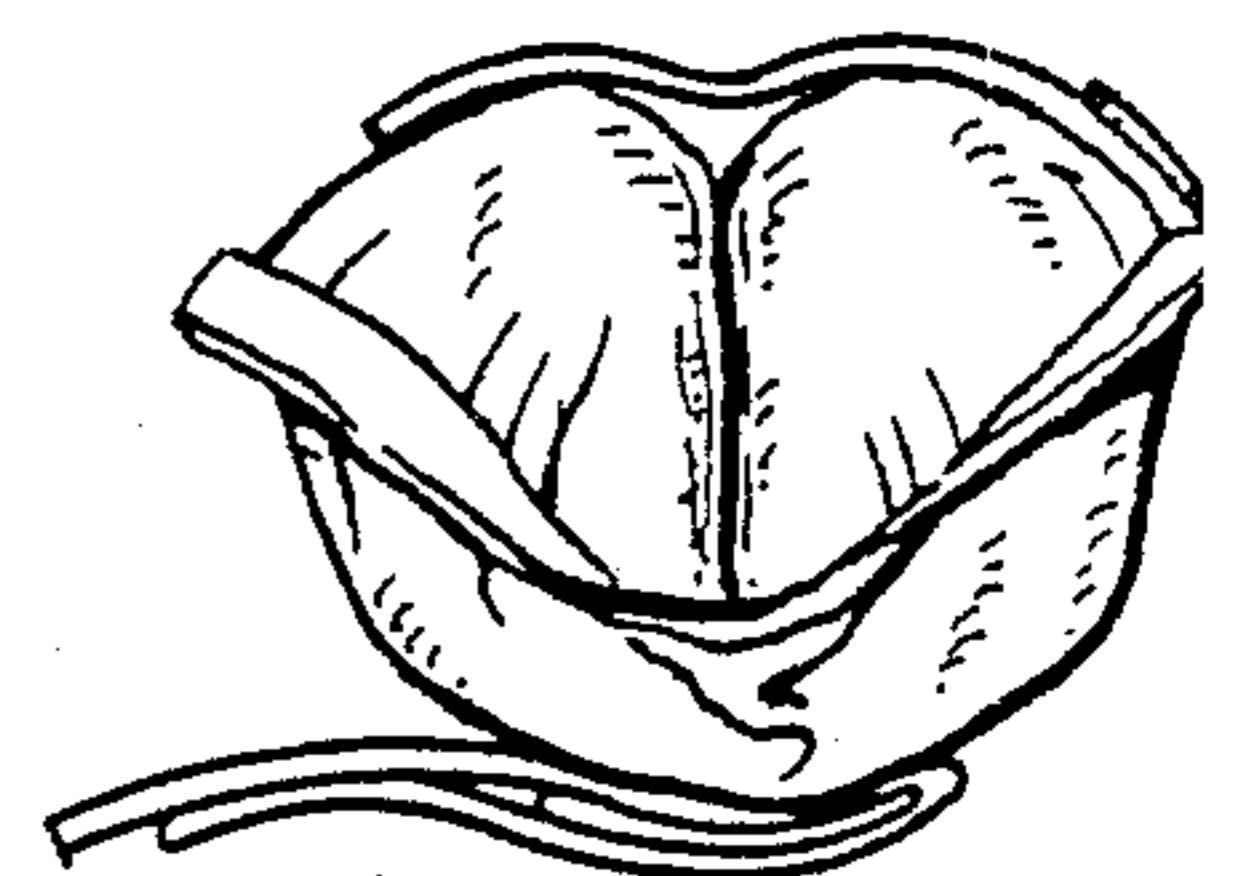

FIG. 4