

[54] **OUTDOOR LIGHT**

- [75] Inventor: **Madhu Patel, Skokie, Ill.**  
[73] Assignee: **Sears, Roebuck and Co., Chicago, Ill.**  
[\*\*] Term: **14 Years**  
[21] Appl. No.: **659,775**  
[22] Filed: **Oct. 11, 1984**

**Related U.S. Application Data**

- [62] Division of Ser. No. 371,714, Apr. 26, 1982, Pat. No. Des. 277,511.  
[52] U.S. Cl. .... **D26/67**  
[58] Field of Search ..... **D26/24, 60-68, D26/138, 140; 362/431, 269, 277, 282, 283, 284, 285, 287, 297, 300, 307, 413, 418, 419, 427, 428**

**References Cited**

**U.S. PATENT DOCUMENTS**

- D. 196,981 11/1963 Pettengill ..... D26/67  
3,263,069 7/1966 Krucki et al. .... 362/431

**FOREIGN PATENT DOCUMENTS**

- 629443 10/1961 Canada ..... 362/431  
220896 12/1962 Japan ..... D26/67

**OTHER PUBLICATIONS**

Artolier Lighting Catalog #18, ©1963, p. 56, Garden Light #G-15.

*Primary Examiner*—Susan J. Lucas  
*Attorney, Agent, or Firm*—Wood, Dalton, Phillips, Mason & Rowe

**CLAIM**

The ornamental design for an outdoor light, as shown and described.

**DESCRIPTION**

FIG. 1 is a front elevational view of an outdoor light, showing my new design;  
FIG. 2 is a top plan view thereof;  
FIG. 3 is a fragmentary cross-sectional view thereof taken on line 3—3 of FIG. 2 on an enlarged scale;  
FIG. 4 is a fragmentary cross-sectional view thereof taken on line 4—4 of FIG. 1;  
FIG. 5 is a rear perspective view thereof with the housing omitted for convenience of illustration;  
FIG. 6 is a rear elevational view thereof with the housing omitted for convenience of illustration;  
FIG. 7 is a front elevational view thereof with the housing omitted for convenience of illustration;  
FIG. 8 is a side elevational view thereof with the housing omitted for convenience of illustration; and  
FIG. 9 is a bottom plan view thereof with the housing omitted for convenience of illustration.

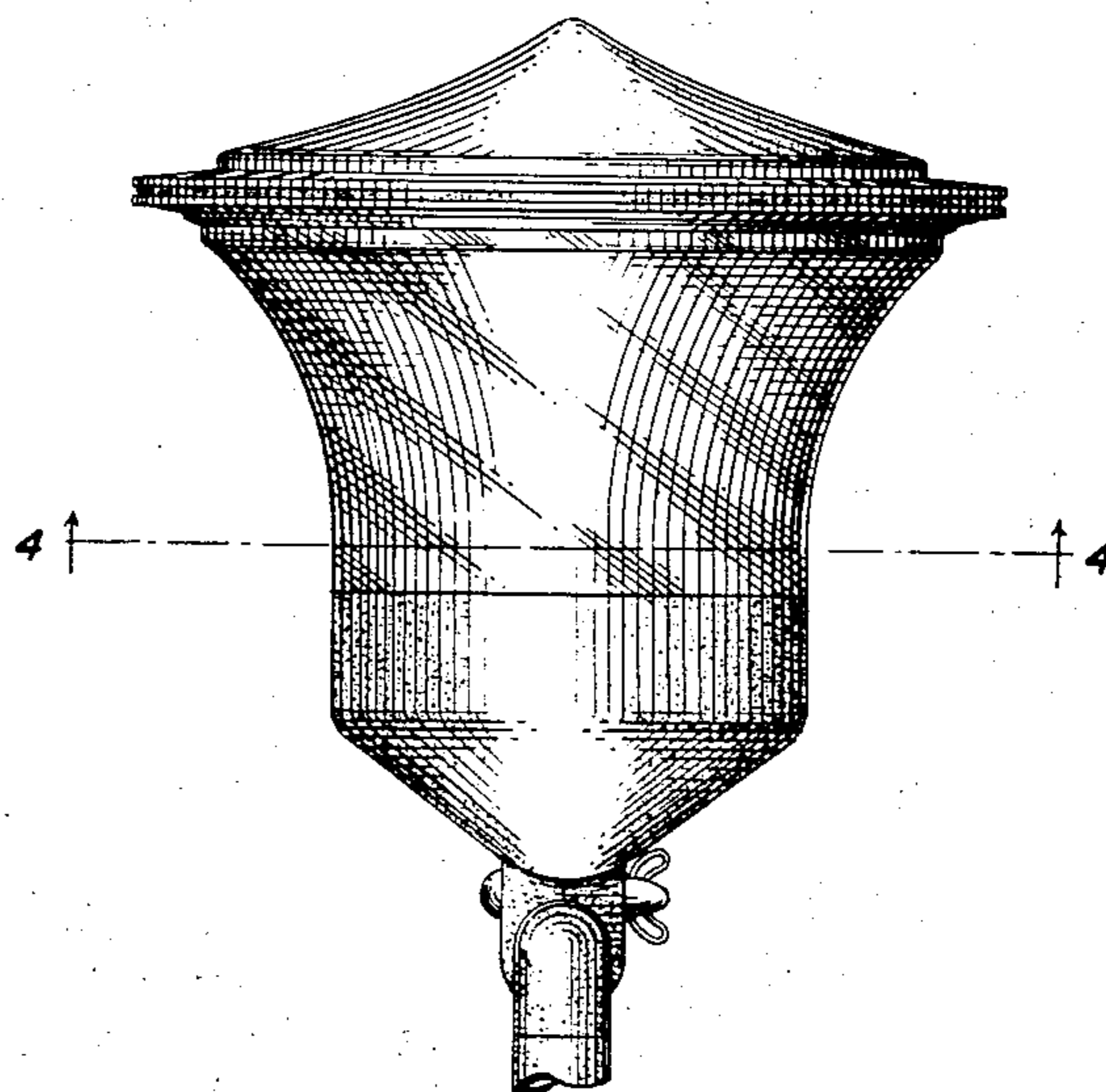

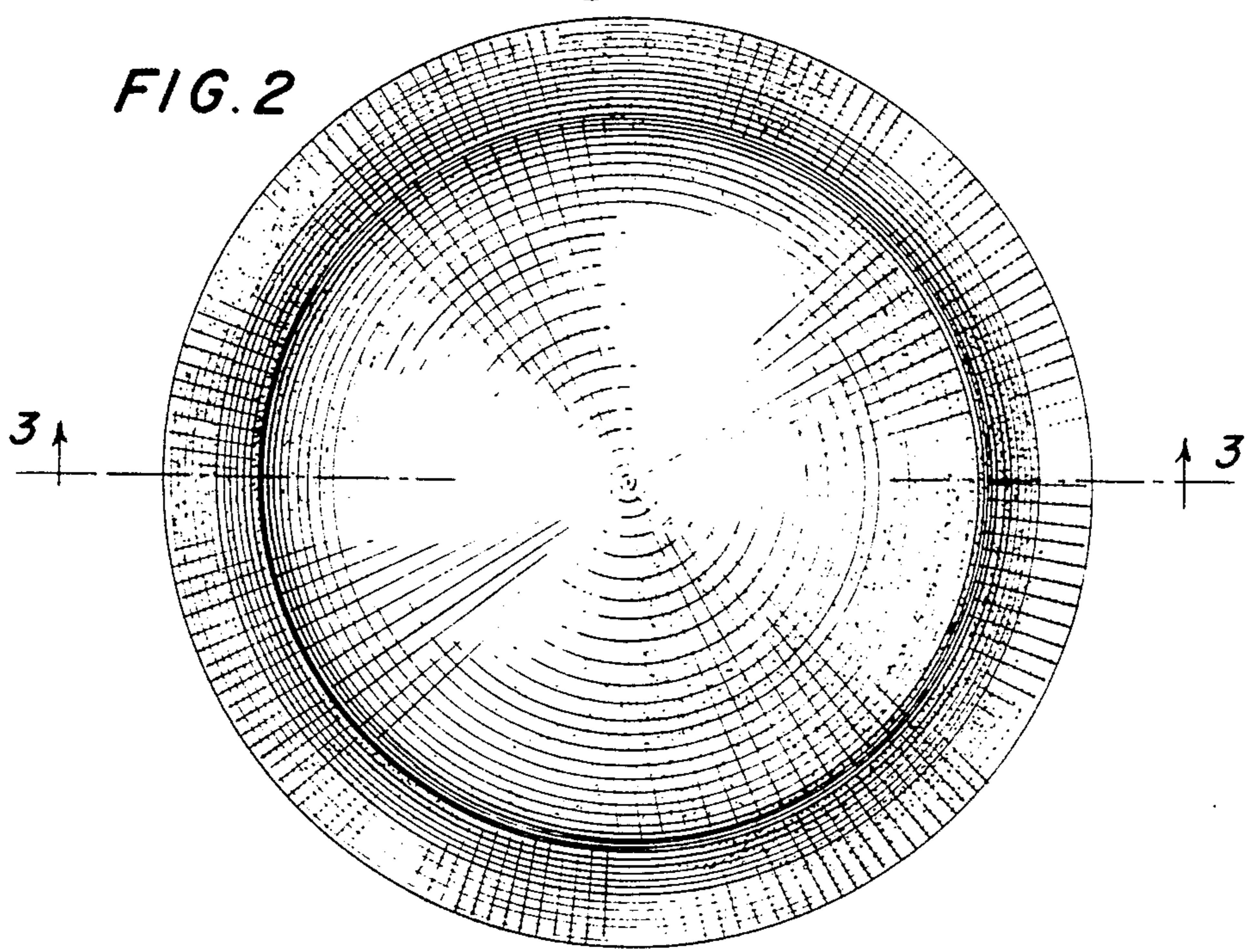
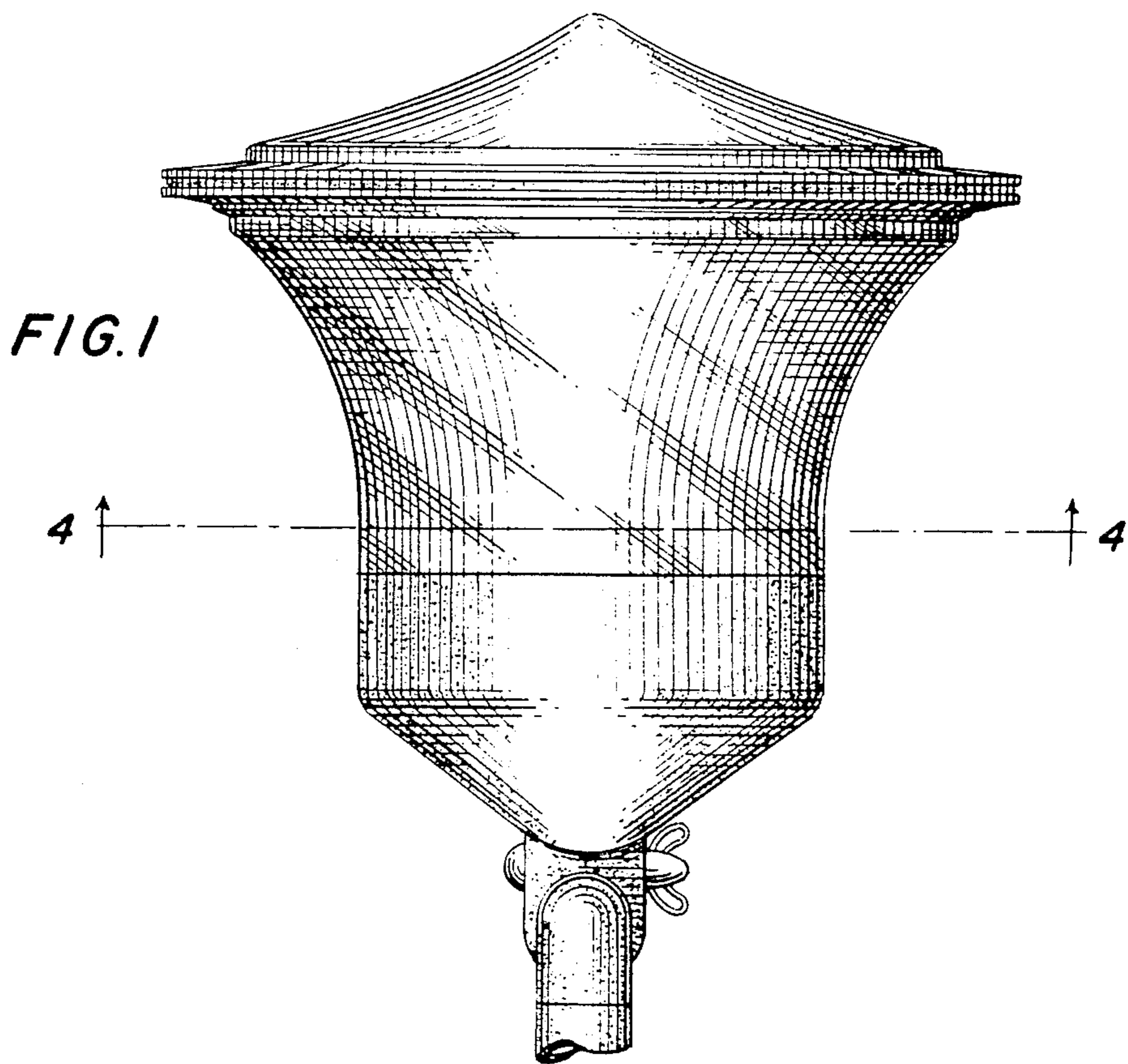



FIG. 3

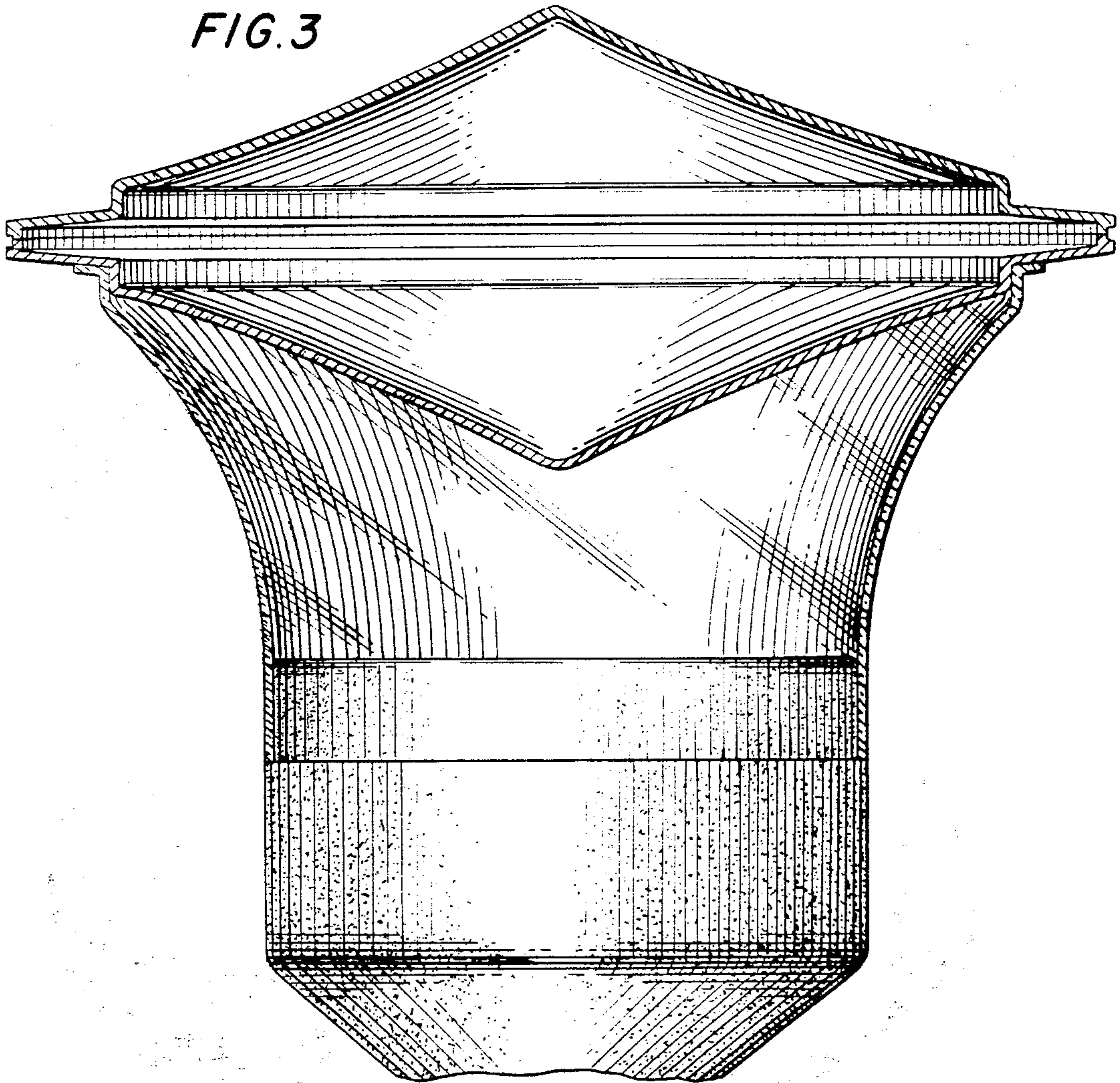
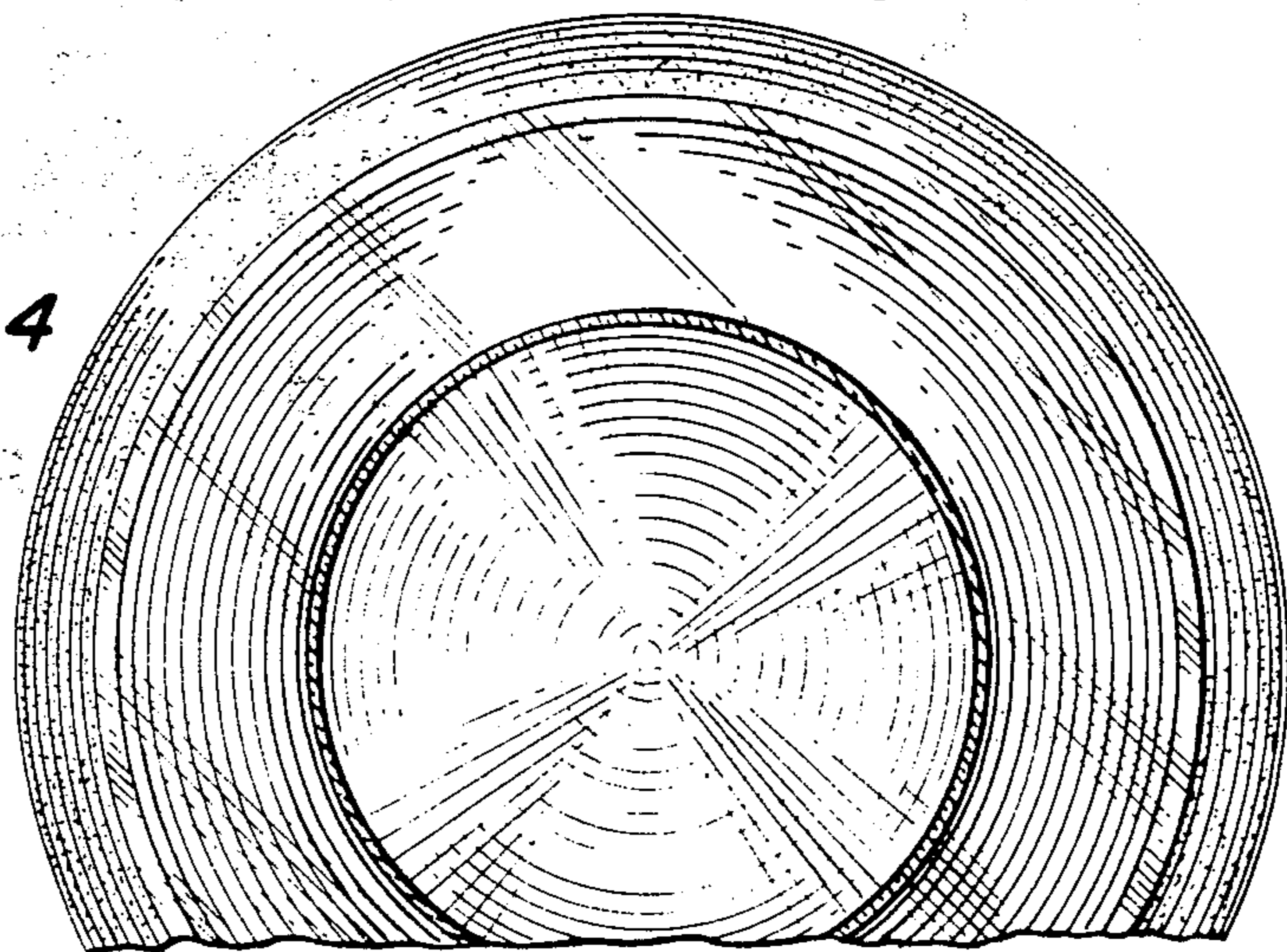

FIG. 4



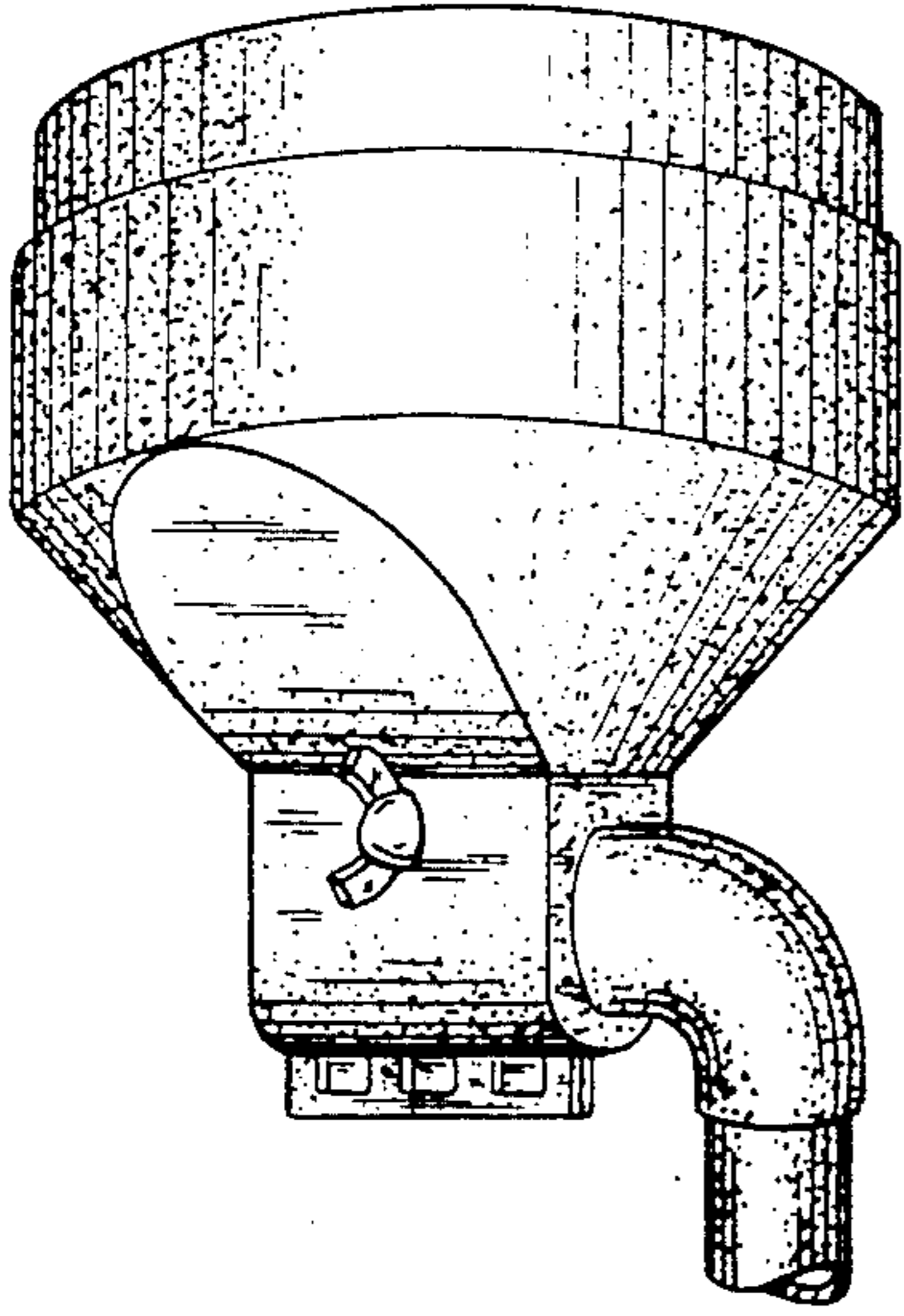

FIG. 5

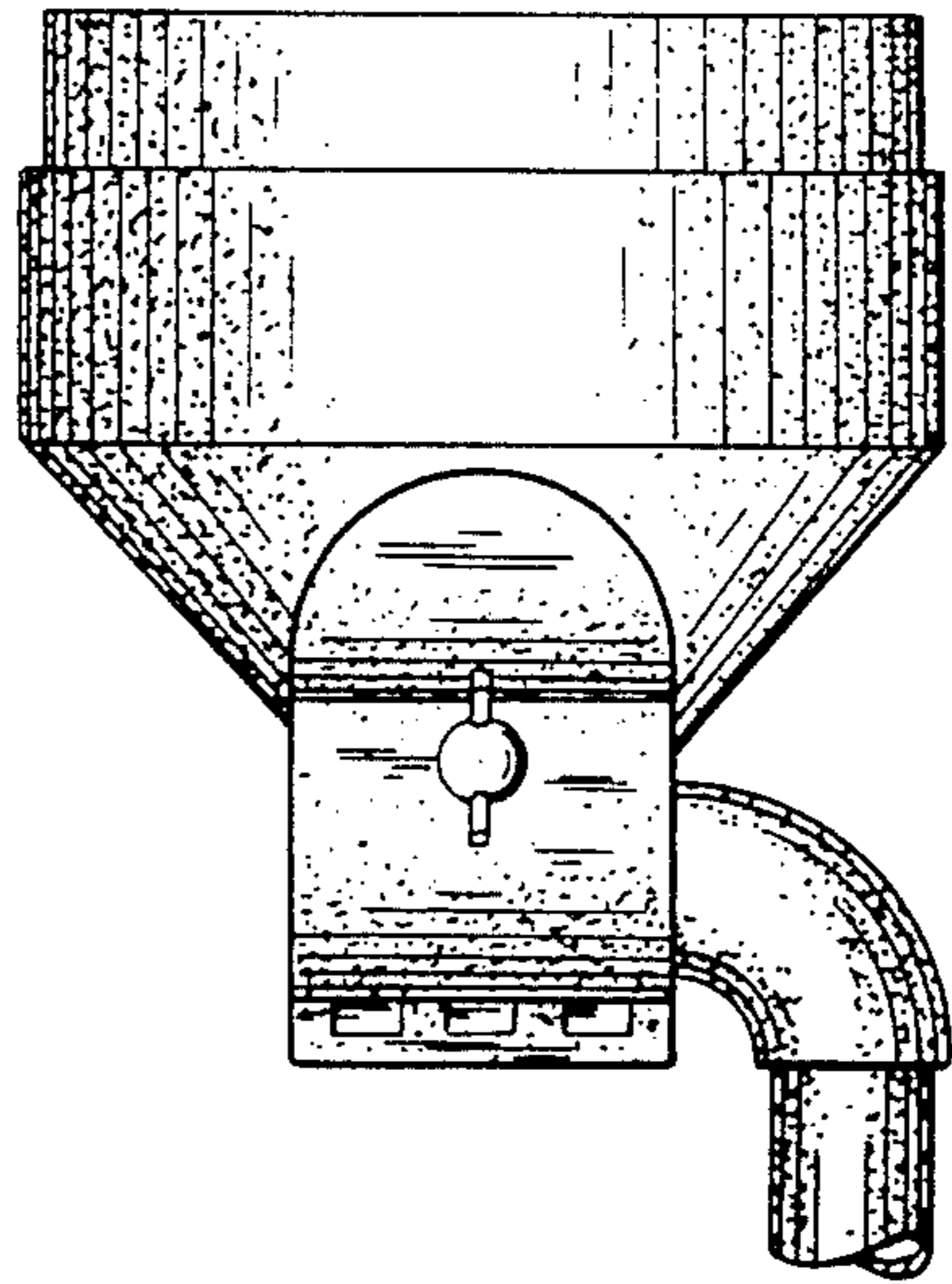

FIG. 6

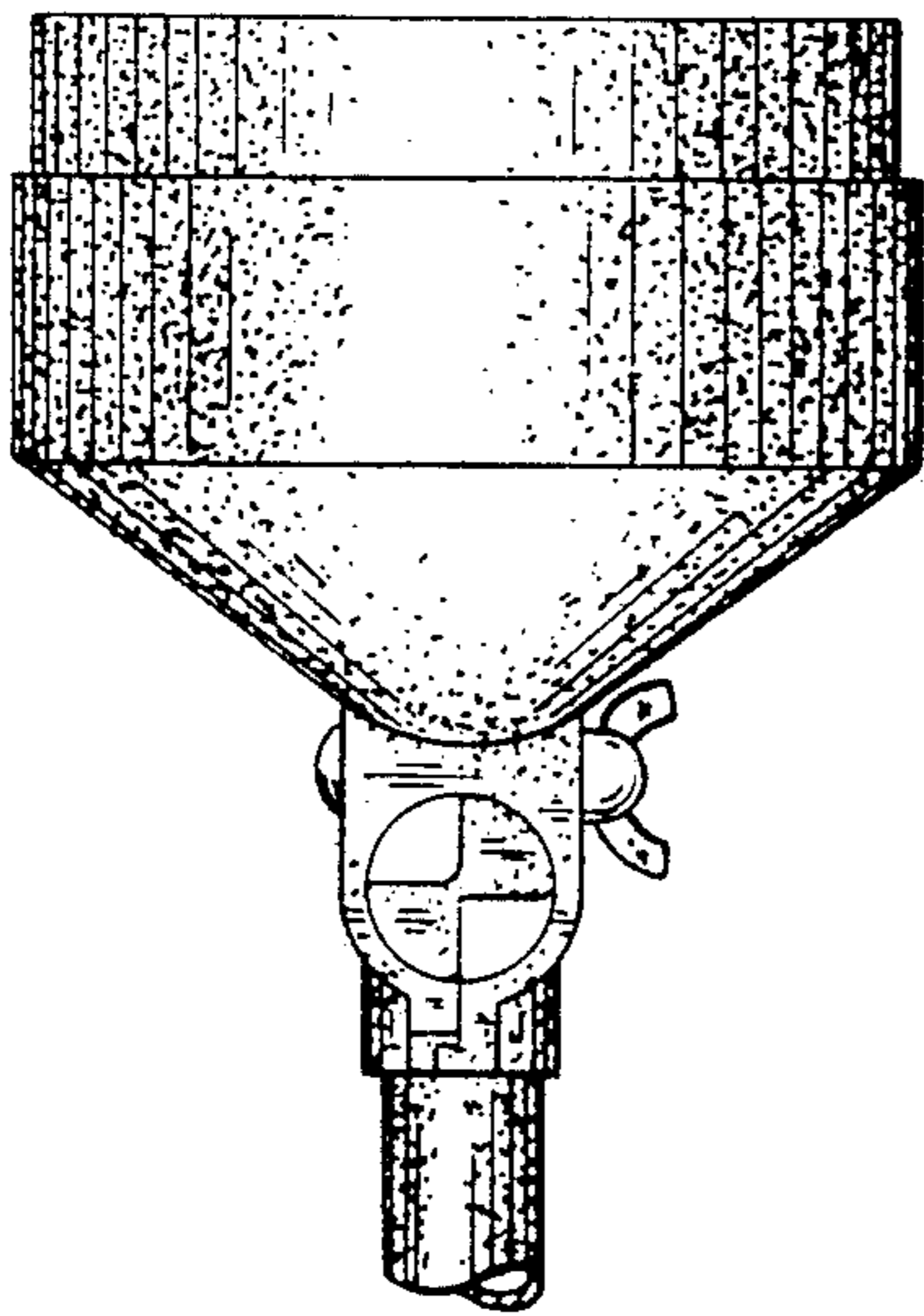

FIG. 8

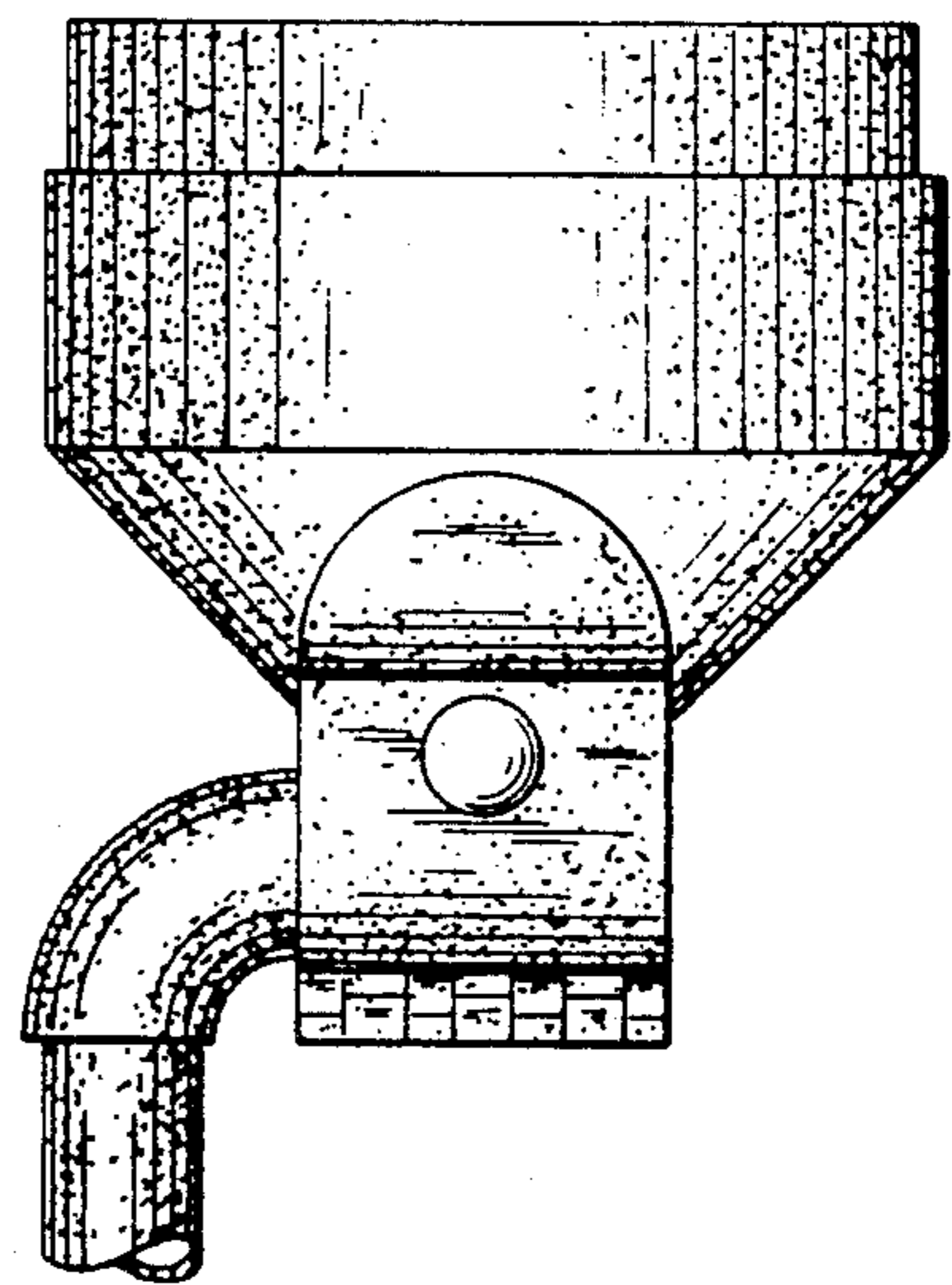

FIG. 7



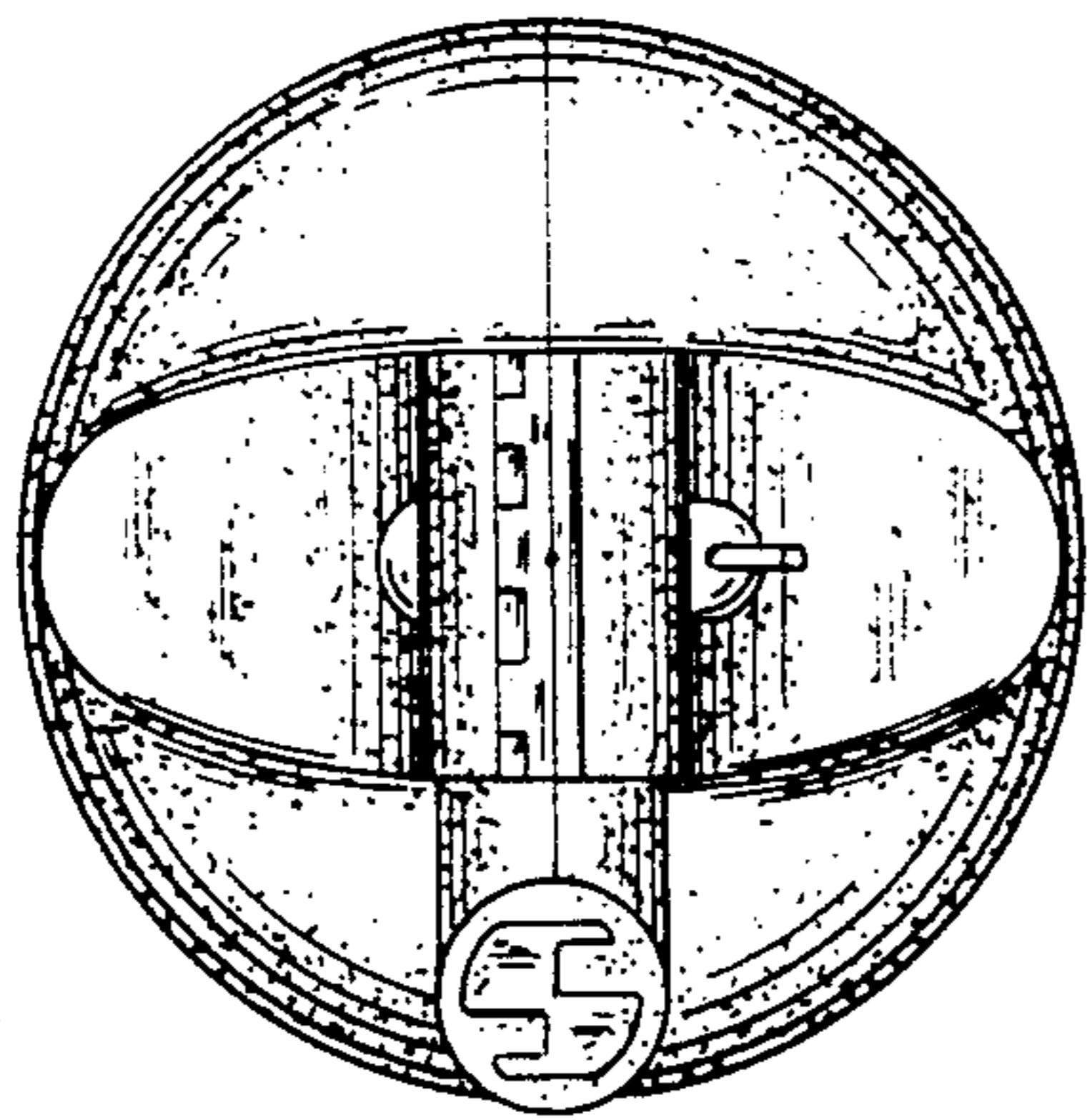

FIG.9