

[54] **HEAT COLLECTOR FOR SMOKE ALARM**

4,236,822 12/1980 Jaretsky et al. 340/628

[76] **Inventor: Laurence Chen, 1116 Via Zumaya,
Rancho Palos Verdes, Calif. 90274**

Primary Examiner—B. J. Bullock
Assistant Examiner—Suzanne N. Gitlin
Attorney, Agent, or Firm—Knobbe, Martens, Olson &
Bear

[**] **Term: 14 Years**

[21] **Appl. No.: 639,244**

[57] **CLAIM**

The ornamental design for a heat collector for smoke alarm, as shown and described.

[22] **Filed: Aug. 9, 1984**

[52] **U.S. Cl. D10/106**

[58] **Field of Search D10/104, 106, 121;
340/628, 629, 630, 693; 250/361-364**

DESCRIPTION

FIG. 1 is a top perspective view of a heat collector for a smoke alarm showing my new design;
FIG. 2 is an enlarged top plan view thereof;
FIG. 3 is an enlarged side elevational view taken in the direction of the arrows along line 3—3 in FIG. 2;
FIG. 4 is a bottom perspective view thereof;
FIG. 5 is an enlarged bottom plan view thereof.

[56] **References Cited**

U.S. PATENT DOCUMENTS

- D. 236,096 7/1975 Sweany D10/106
- 2,476,958 7/1949 Cahubauc et al. 340/630
- 3,900,795 8/1975 Larsen et al. 340/628

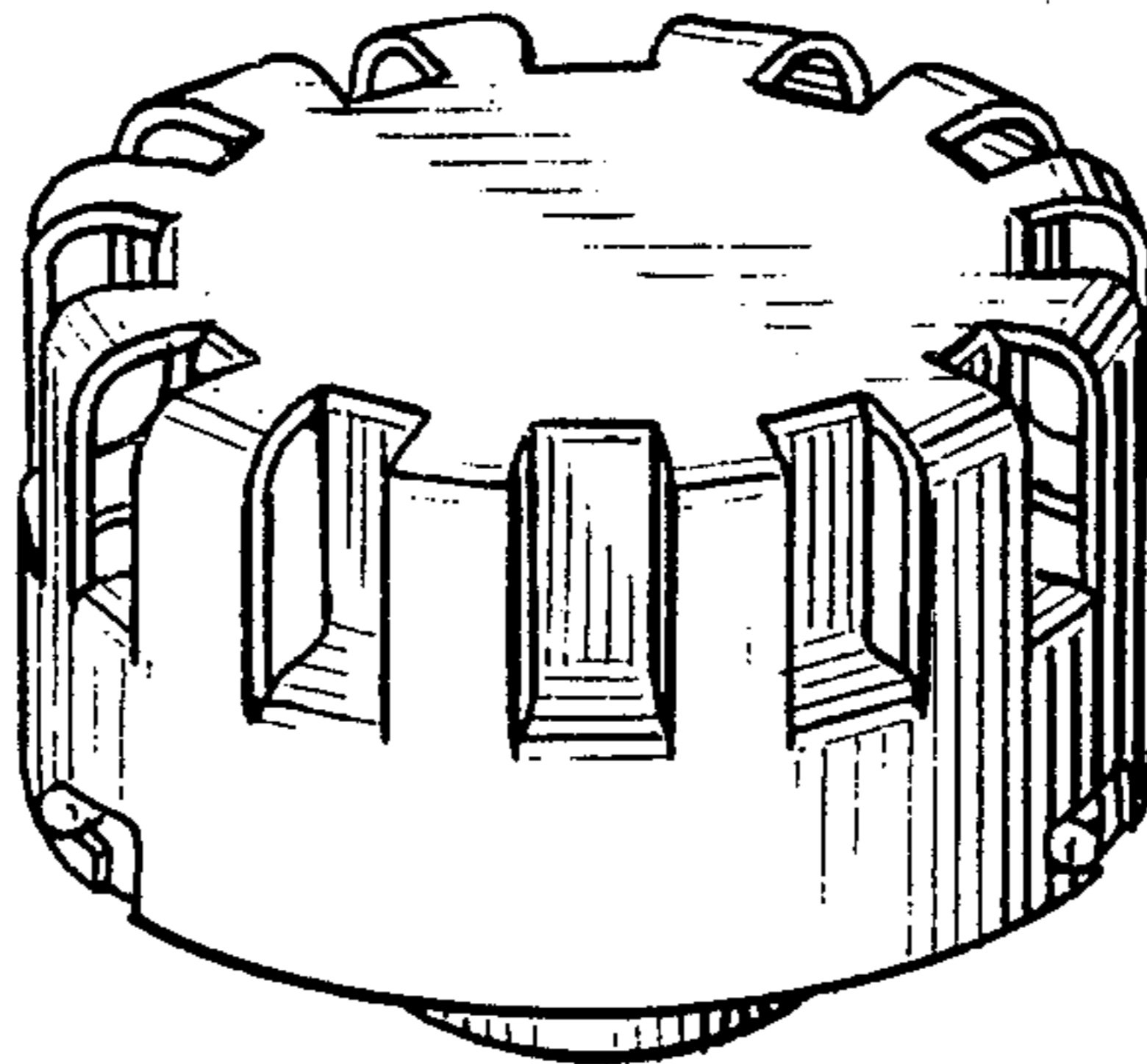

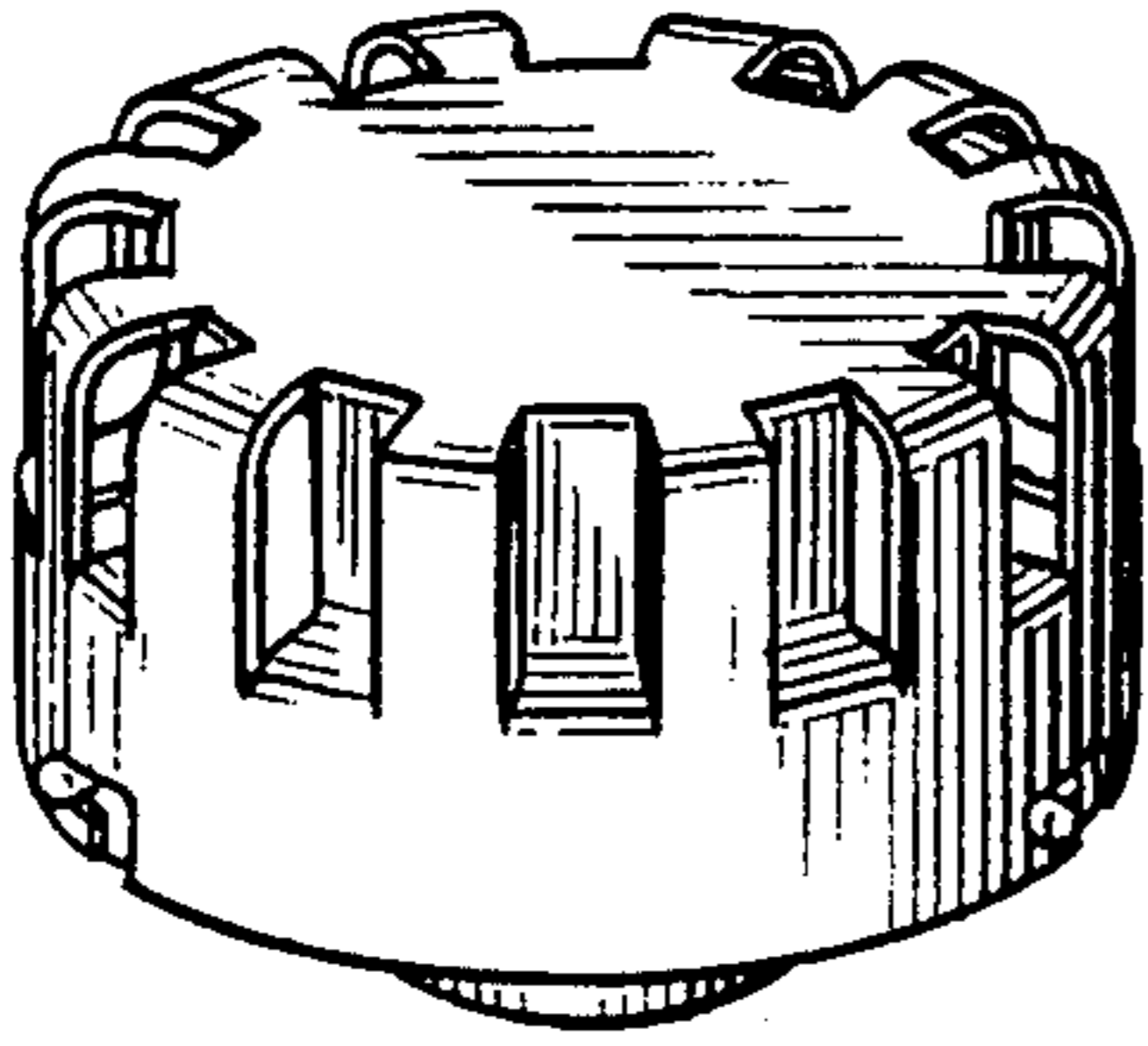

Fig. 1.

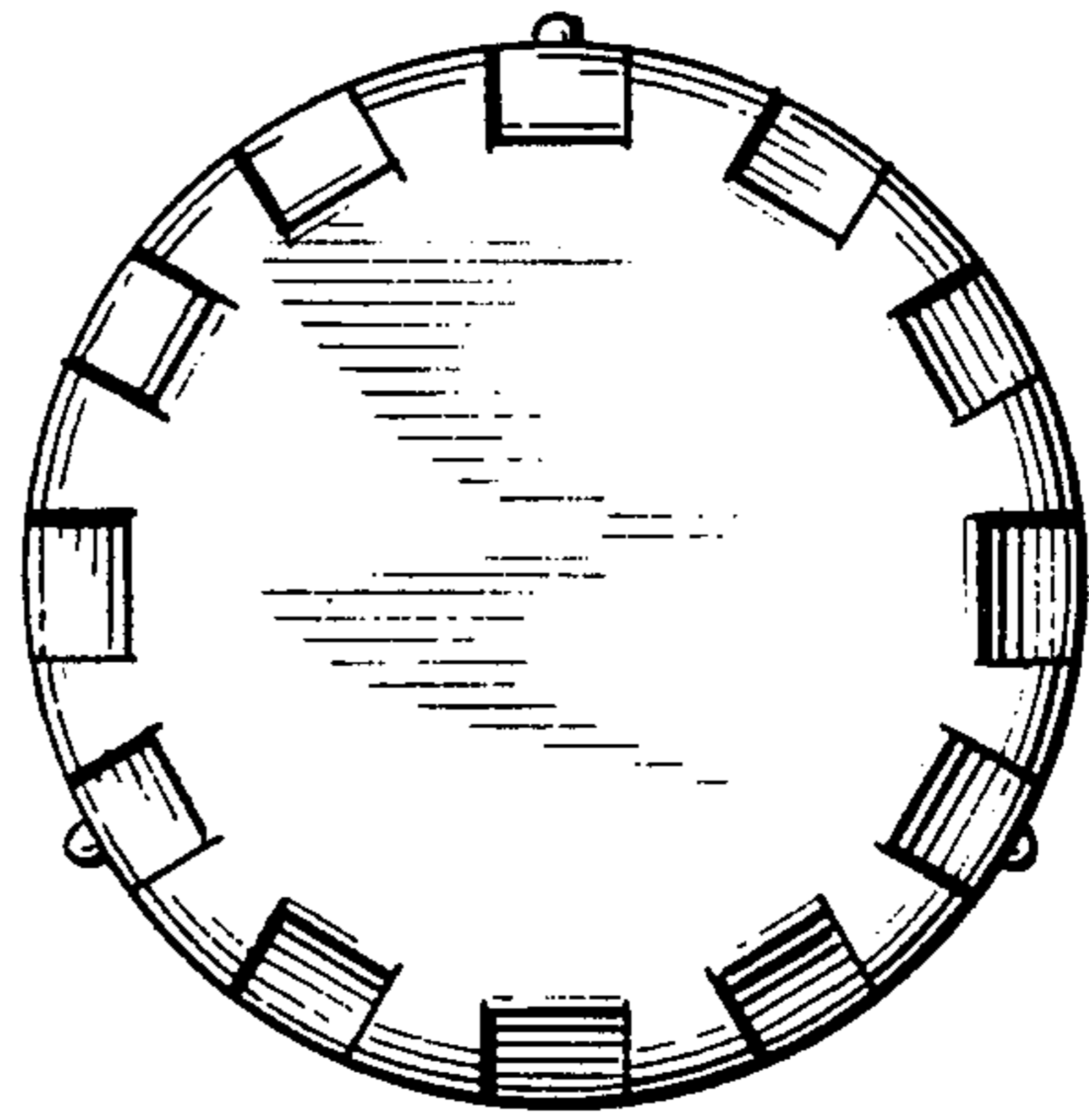

Fig. 2.

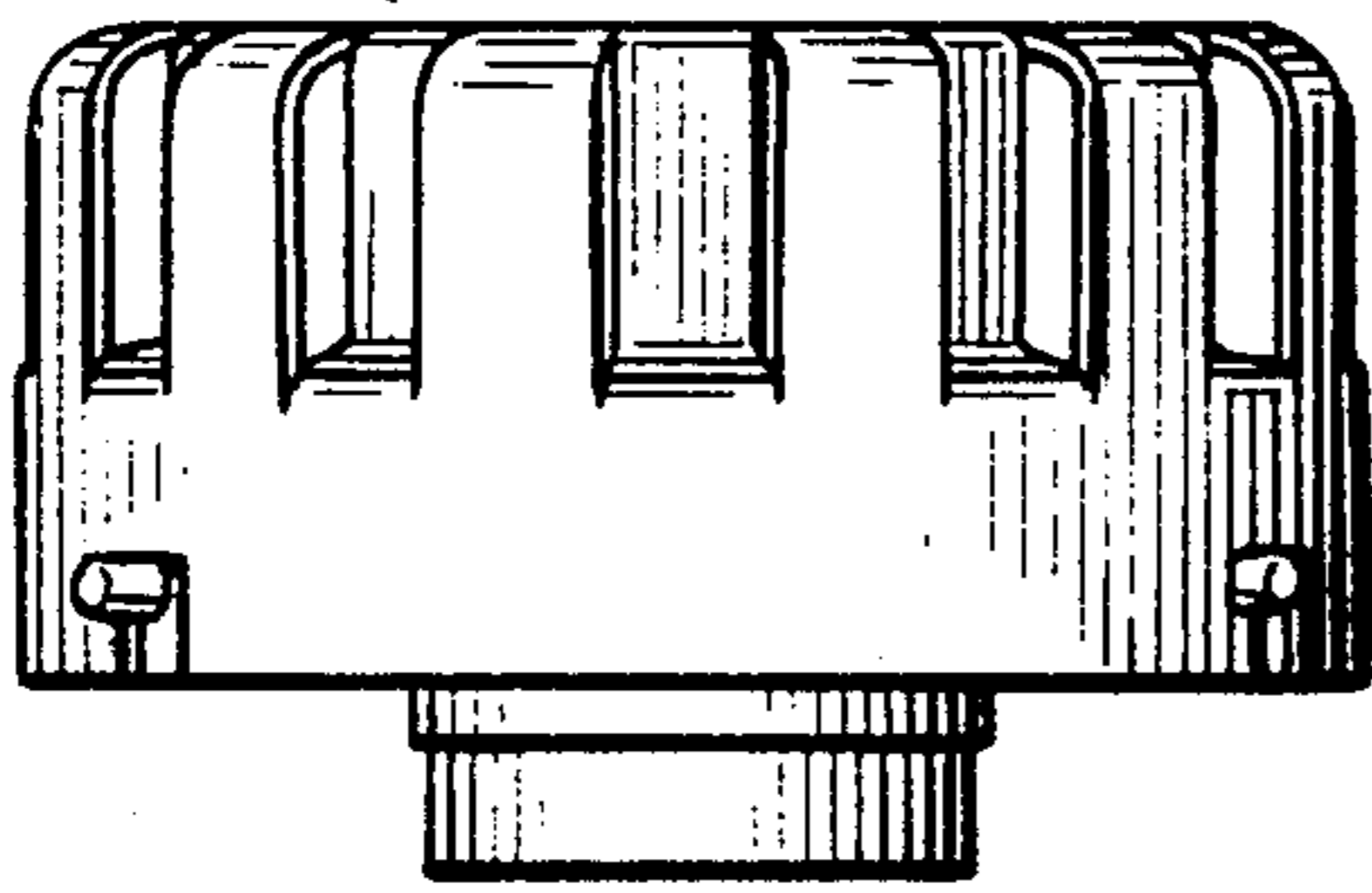

Fig. 3.

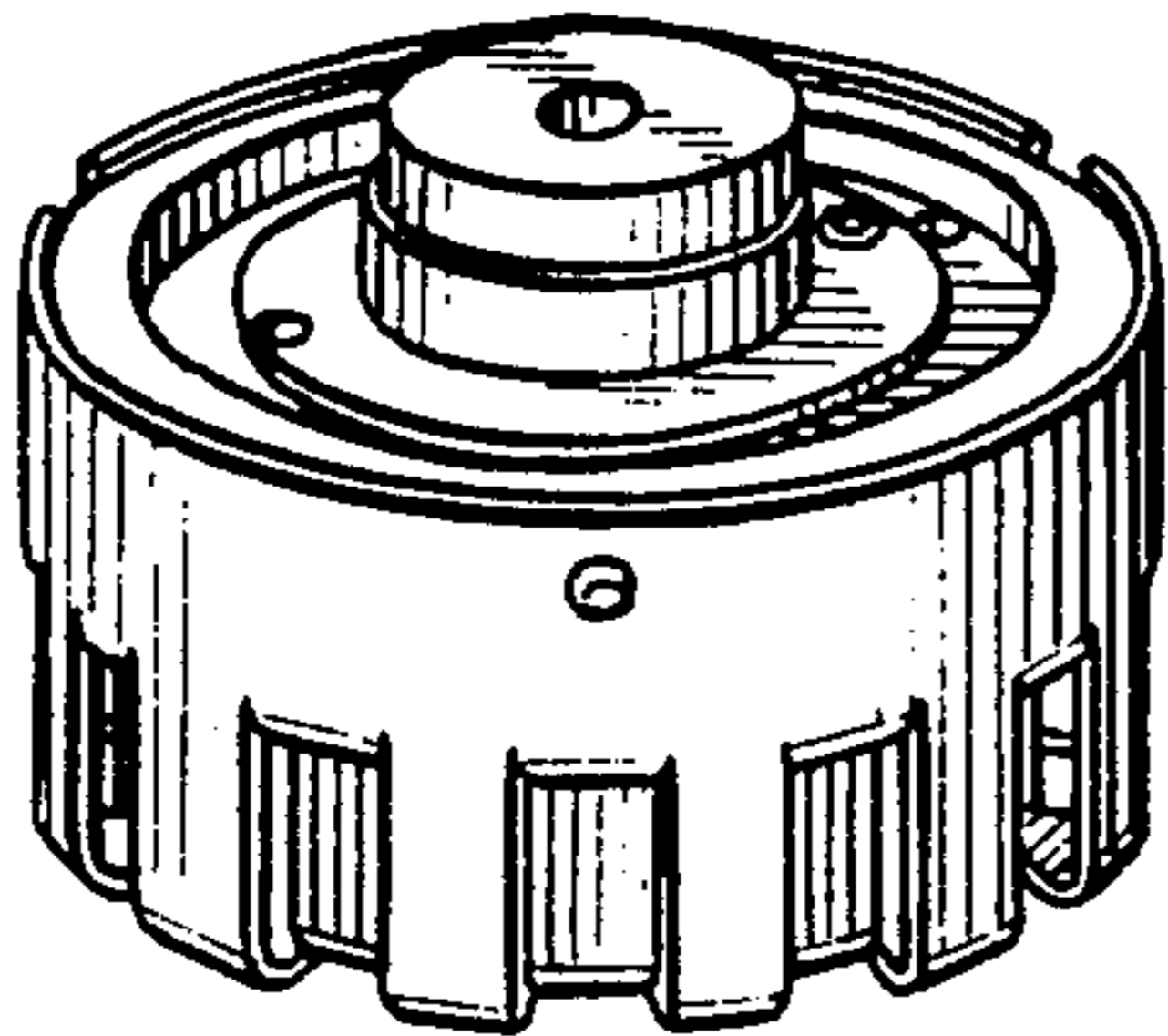

Fig. 5.

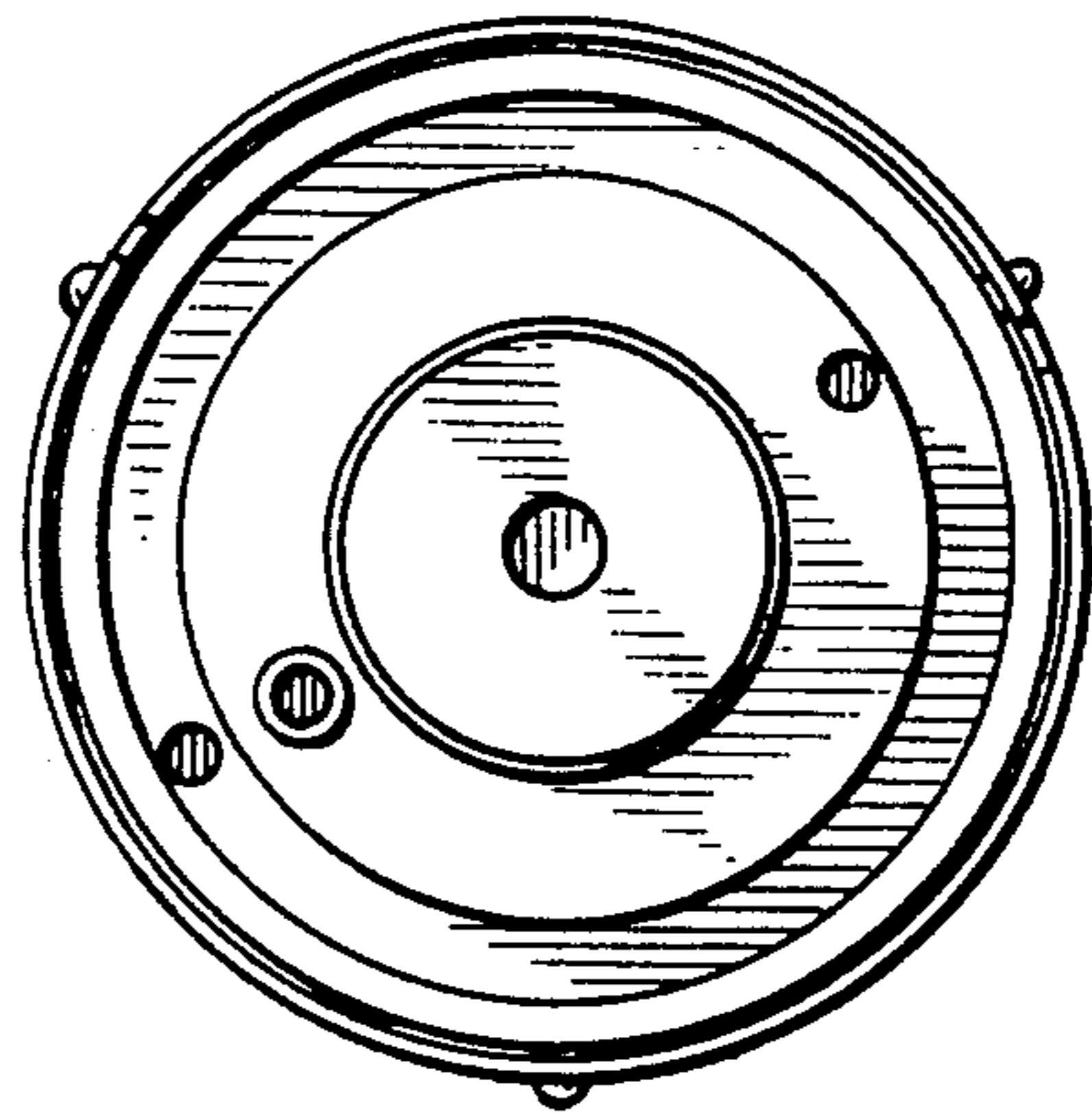

Fig. 4.

UNITED STATES PATENT AND TRADEMARK OFFICE
CERTIFICATE OF CORRECTION

PATENT NO. : DES 283,989
DATED : May 27, 1986
INVENTOR(S) : Laurence Chen

Page 1 of 3

It is certified that error appears in the above-identified patent and that said Letters Patent is hereby corrected as shown below:

The title page should be deleted to appear as per attached title page.

The sheet of drawing containing figures 1-5 should be deleted to be replaced with figures 1-5 as shown on the attached sheet.

Signed and Sealed this
Twenty-second Day of March, 1988

Attest:

DONALD J. QUIGG

Attesting Officer

Commissioner of Patents and Trademarks

United States Patent [19]
Chen

[11] **Patent Number: Des. 283,989**
[45] **Date of Patent: ** May 27, 1986**

- [54] **HEAT COLLECTOR FOR SMOKE ALARM**
- [76] **Inventor: Laurence Chen, 1116 Via Zumaya, Rancho Palos Verdes, Calif. 90274**
- [**] **Term: 14 Years**
- [21] **Appl. No.: 639,244**
- [22] **Filed: Aug. 9, 1984**
- [52] **U.S. Cl. D10/106**
- [58] **Field of Search D10/104, 106, 121; 340/628, 629, 630, 693; 250/361-364**

4,236,822 12/1980 Jaretsky et al. 340/628

Primary Examiner—B. J. Bullock
Assistant Examiner—Suzanne N. Gitlin
Attorney, Agent, or Firm—Knobbe, Martens, Olson & Bear

[57] **CLAIM**

The ornamental design for a heat collector for smoke alarm, as shown and described.

DESCRIPTION

FIG. 1 is a top perspective view of a heat collector for a smoke alarm showing my new design;
FIG. 2 is an enlarged top plan view thereof;
FIG. 3 is an enlarged side elevational view taken in the direction of the arrows along line 3—3 in FIG. 2;
FIG. 4 is a bottom perspective view thereof;
FIG. 5 is an enlarged bottom plan view thereof.

- [56] **References Cited**
- U.S. PATENT DOCUMENTS**
- D. 236,096 7/1975 Sweany D10/106
- 2,476,958 7/1949 Cahubauc et al. 340/630
- 3,900,795 8/1975 Larsen et al. 340/628

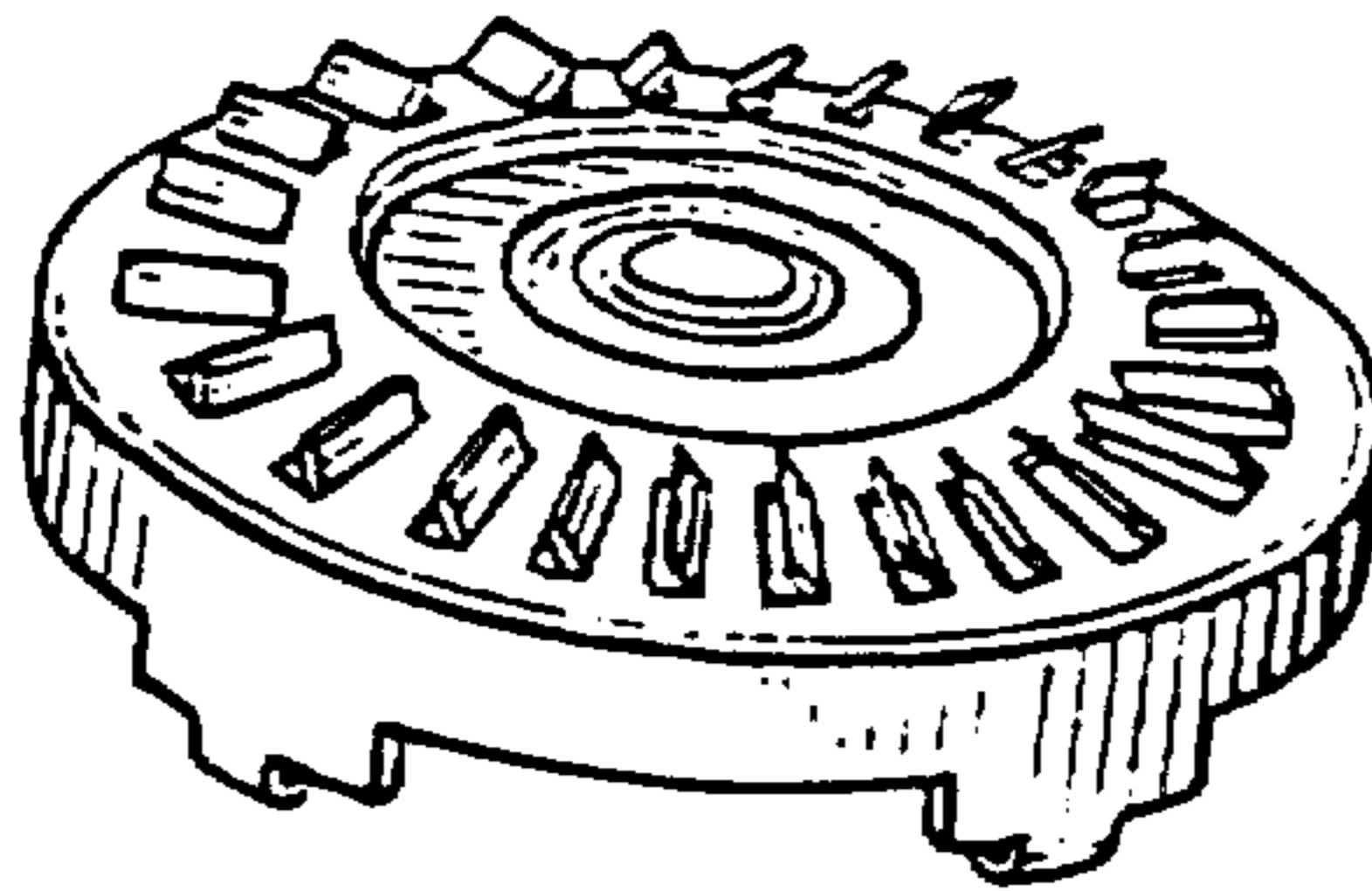

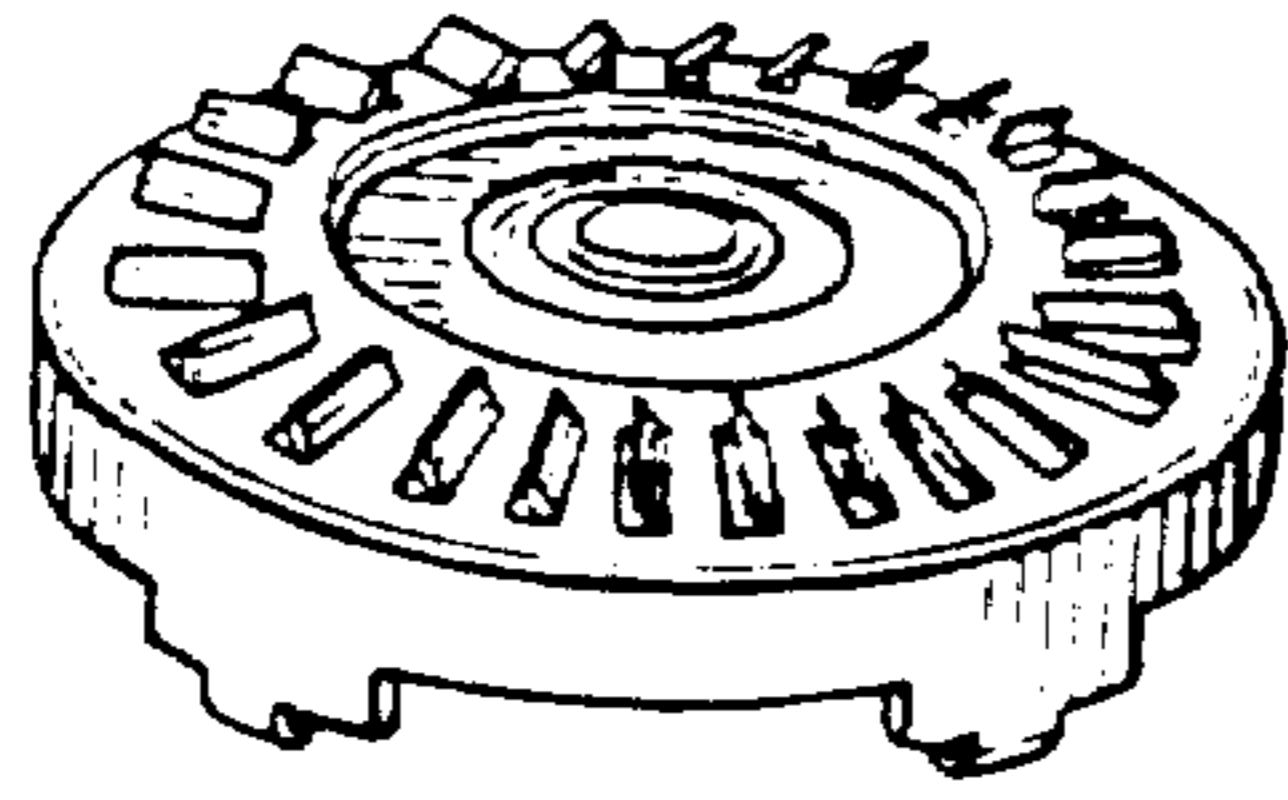

Fig. 1.

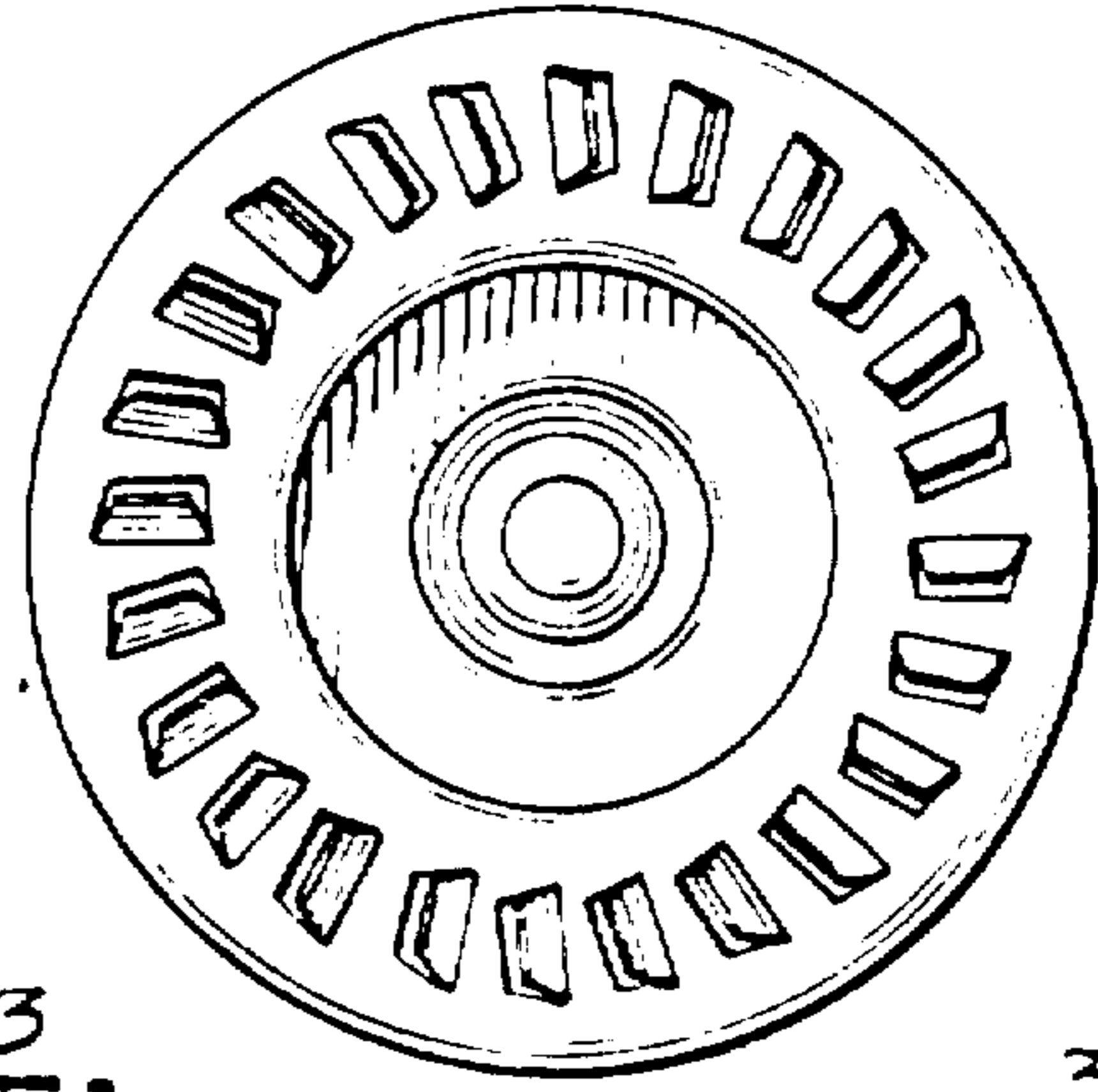

Fig. 2.

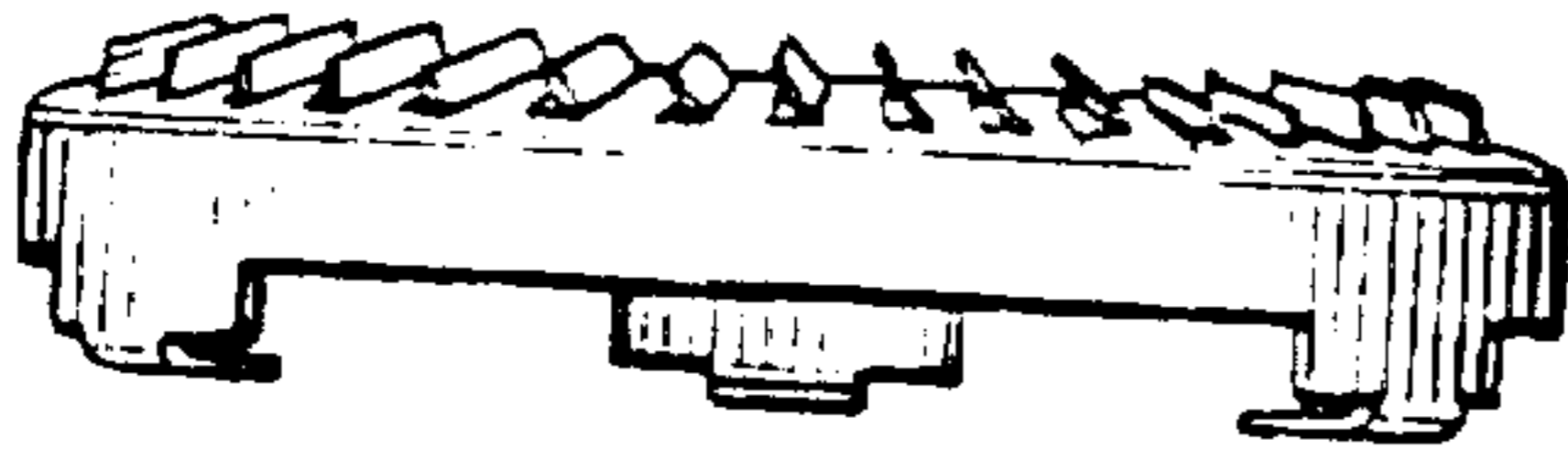

Fig. 3.

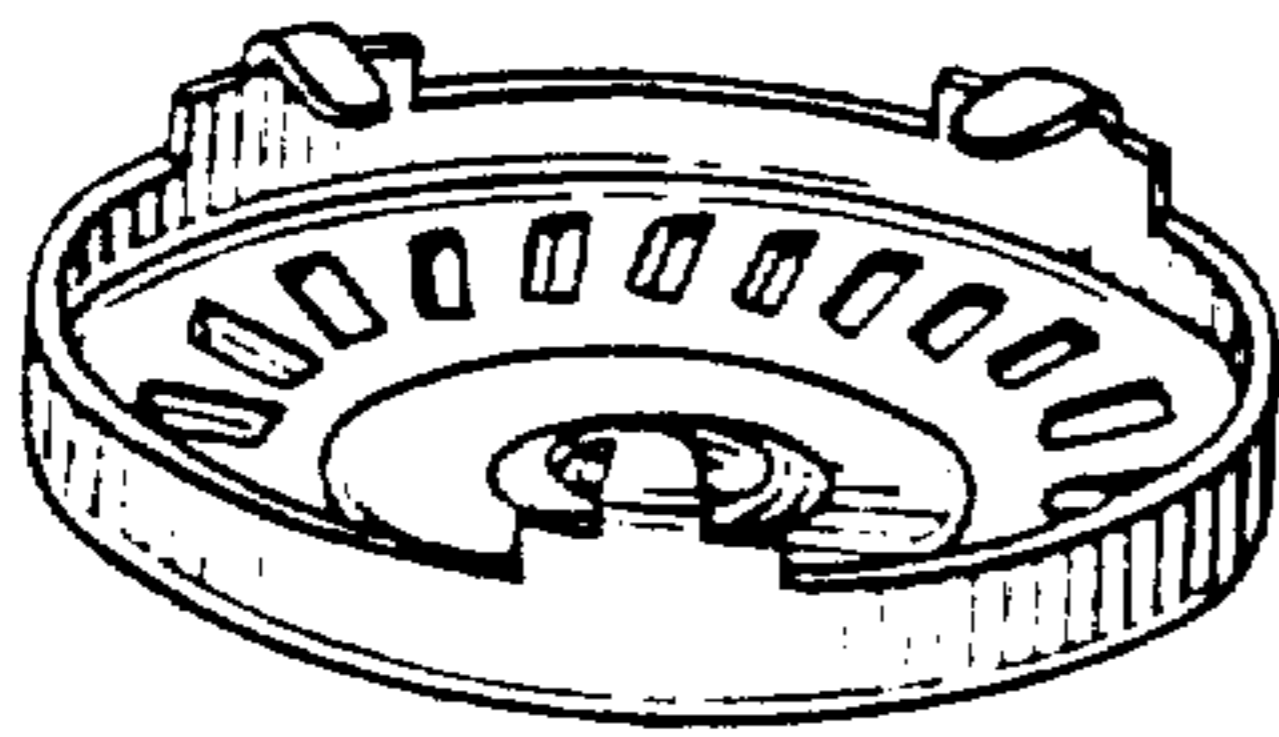

Fig. 4.

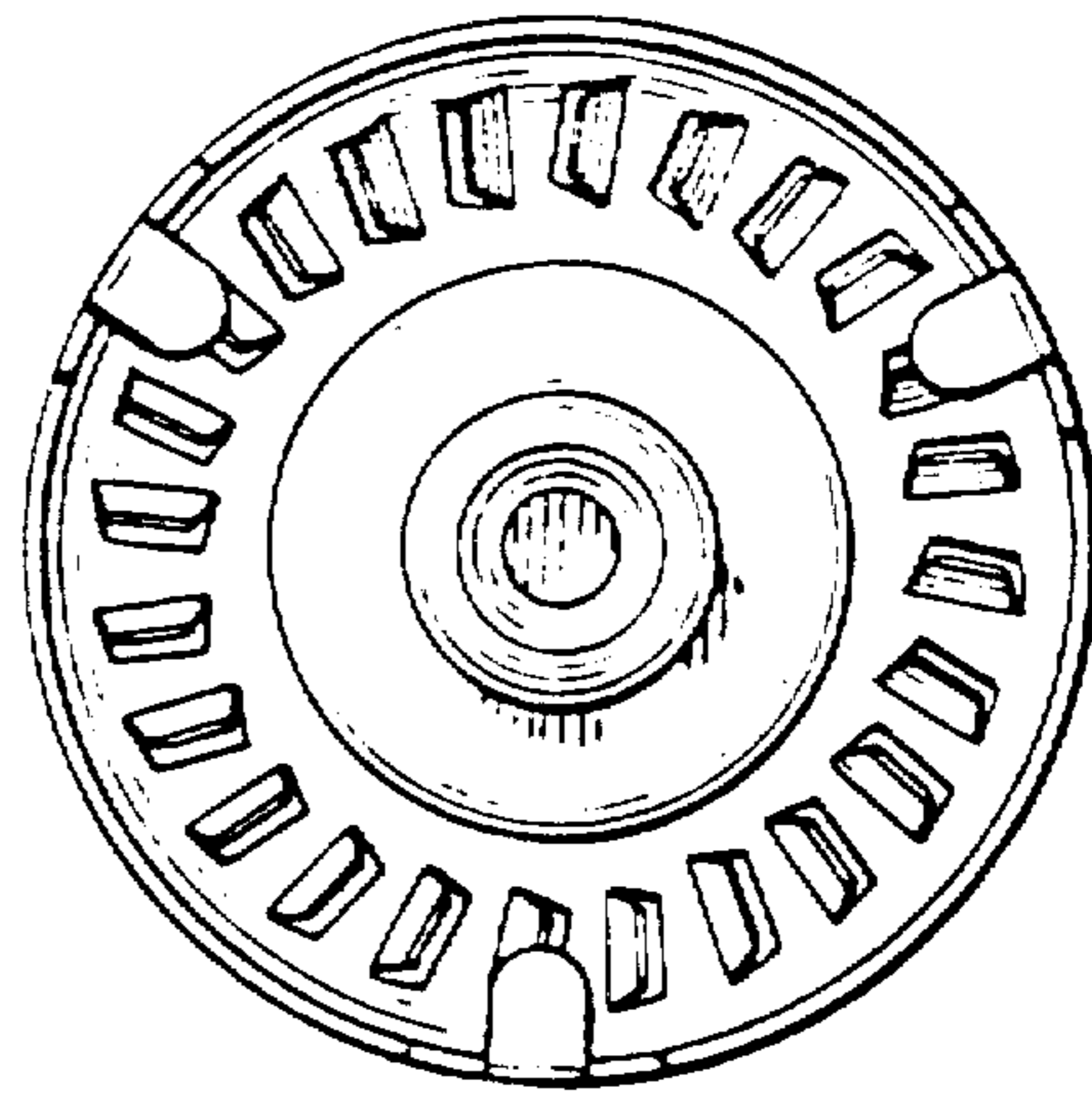

Fig. 5.