

[54] TOOTHBRUSH

[76] Inventors: Staffan Plantén, Parkstrasse 15, 7064 Remshalden-Buoch; Torbjoern Askeroth, Ebingerstrasse 43; Eric Alton, Gustav-Blickle-Strasse 9, both of D-7472 Winterlingen, all of Fed. Rep. of Germany

[**] Term: 14 Years

[21] Appl. No.: 652,789

[22] Filed: Sep. 20, 1984

[30] Foreign Application Priority Data

Jun. 7, 1984 [DE] Fed. Rep. of Germany 1946-84

[52] U.S. Cl. D4/105

[58] Field of Search D4/104-113; 15/159 R, 167 R, 167 A; 132/84; 128/62 A

[56] References Cited

U.S. PATENT DOCUMENTS

741,722 10/1903 Ryder et al. 15/167 R
1,565,750 12/1925 Nathanson 15/167 A
1,679,946 8/1928 Ruff 15/167 A

2,283,686 5/1942 McCune 128/62 A
3,067,447 12/1962 Birch 15/167 A
3,146,478 9/1964 Rosenthal 15/167 R X
4,486,914 12/1984 Planten et al. 15/167 A

FOREIGN PATENT DOCUMENTS

169217 9/1921 United Kingdom 15/167 A

Primary Examiner—Catherine E. Kemper
Attorney, Agent, or Firm—Flynn, Thiel, Boutell & Tanis

[57] CLAIM

The ornamental design for a toothbrush, as shown and described.

DESCRIPTION

FIG. 1 is a top plan view of a toothbrush showing our new design;
FIG. 2 is a bottom plan view thereof;
FIG. 3 is a left side elevational view thereof, the right side elevational view being a mirror image thereof;
FIG. 4 is a front view thereof;
FIG. 5 is a rear view thereof;
FIG. 6 is a perspective view thereof;
FIG. 7 is a top plan view of a second embodiment of a toothbrush.

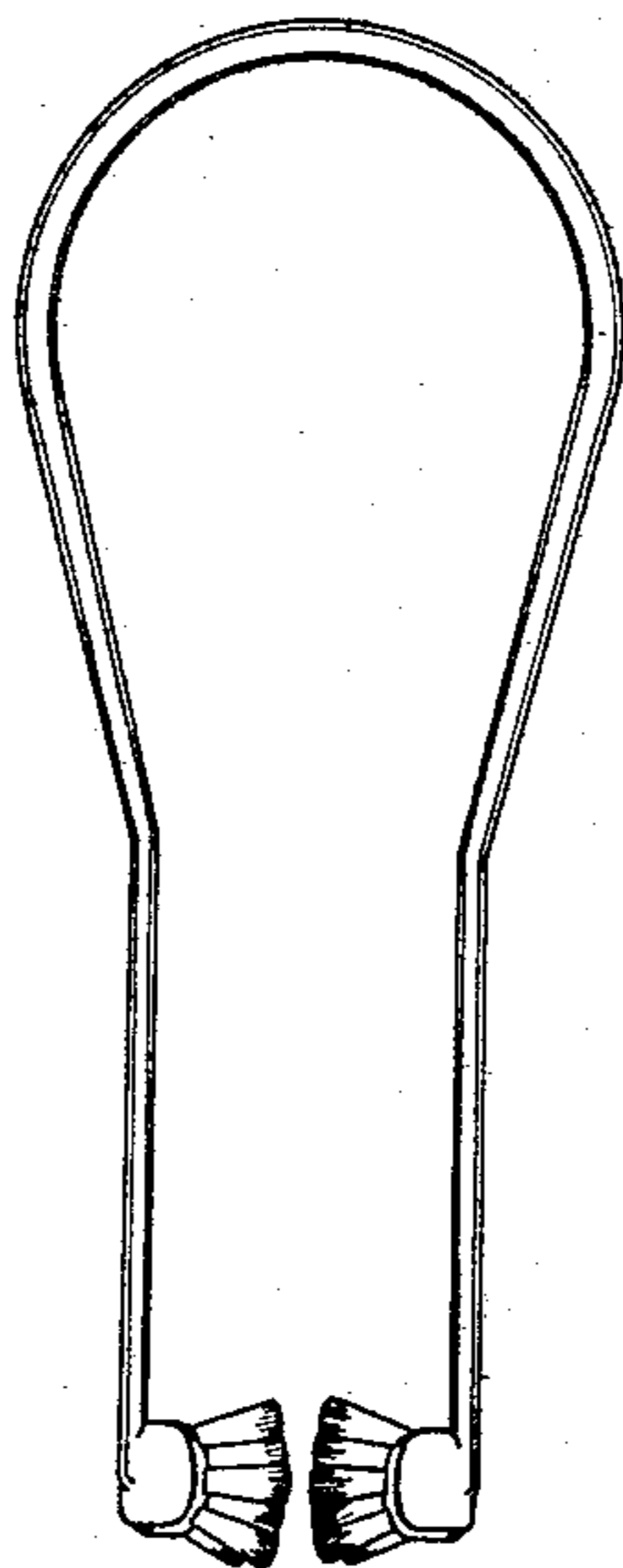

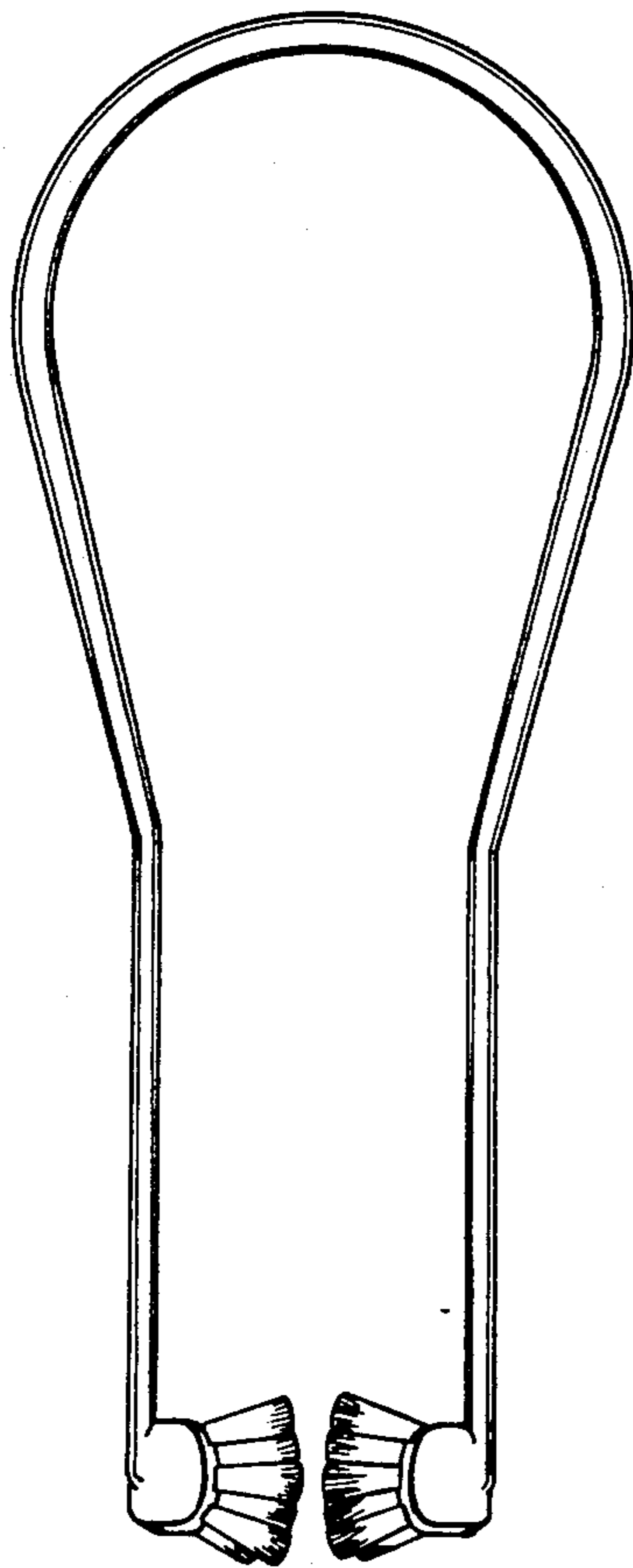

FIG. 1

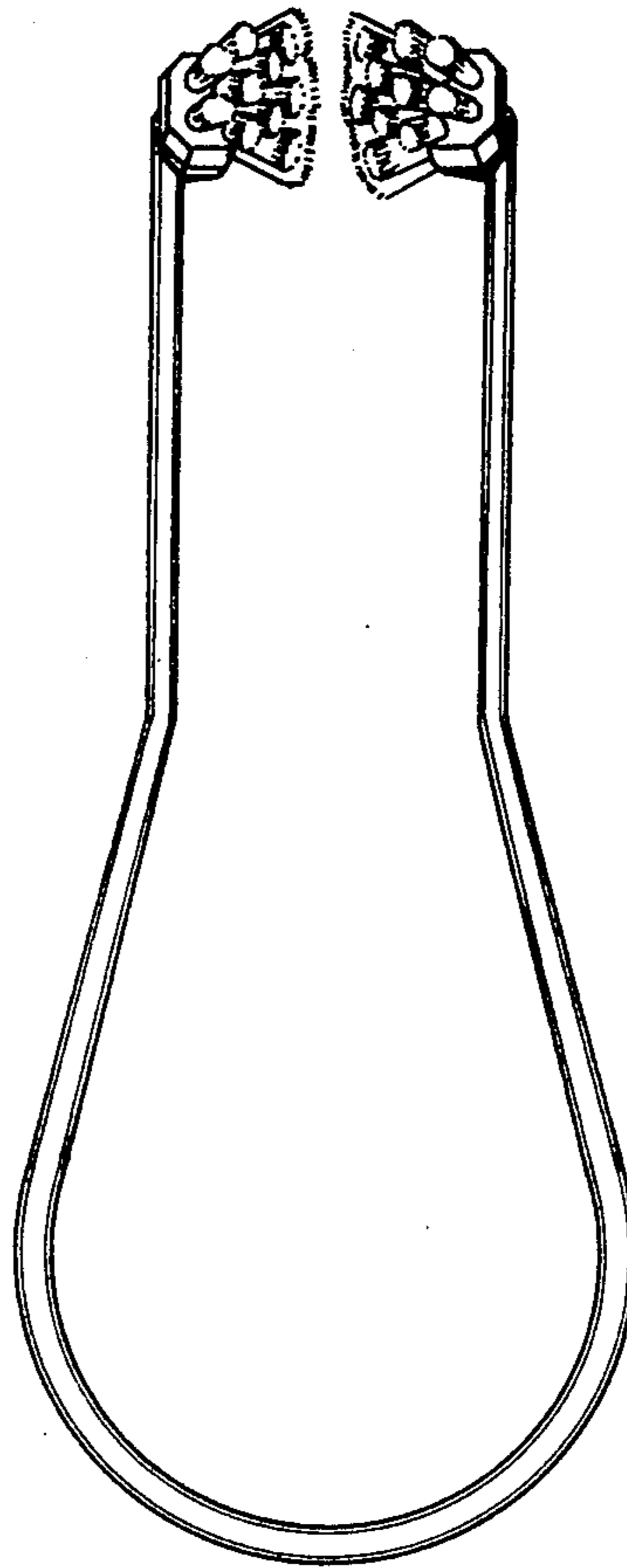

FIG. 2

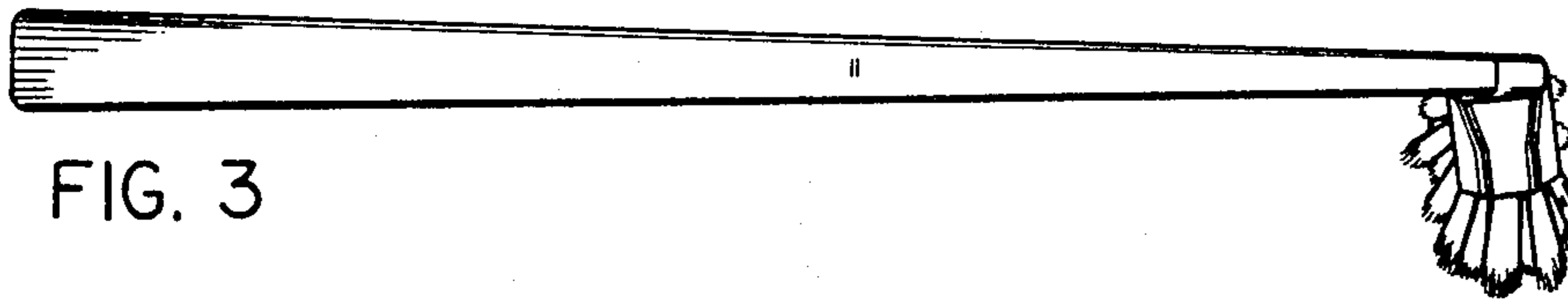

FIG. 3

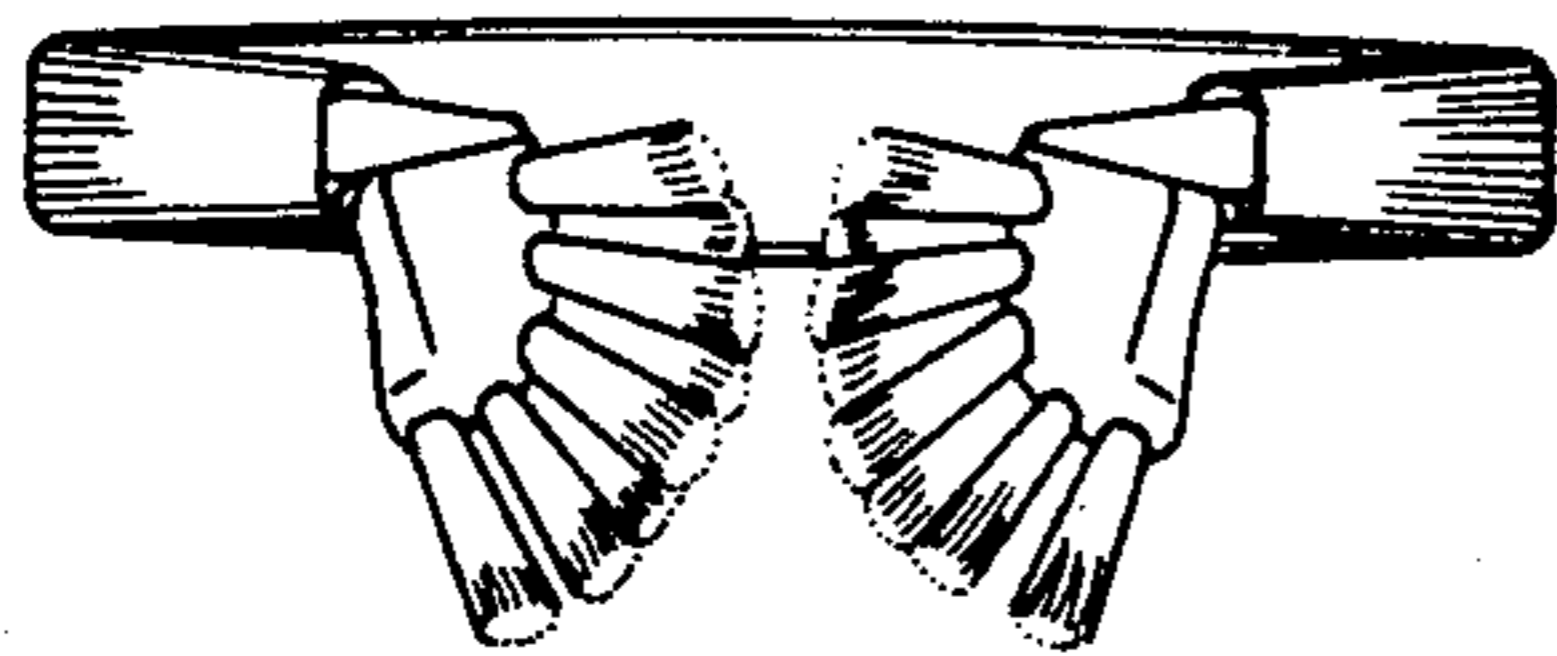

FIG. 4

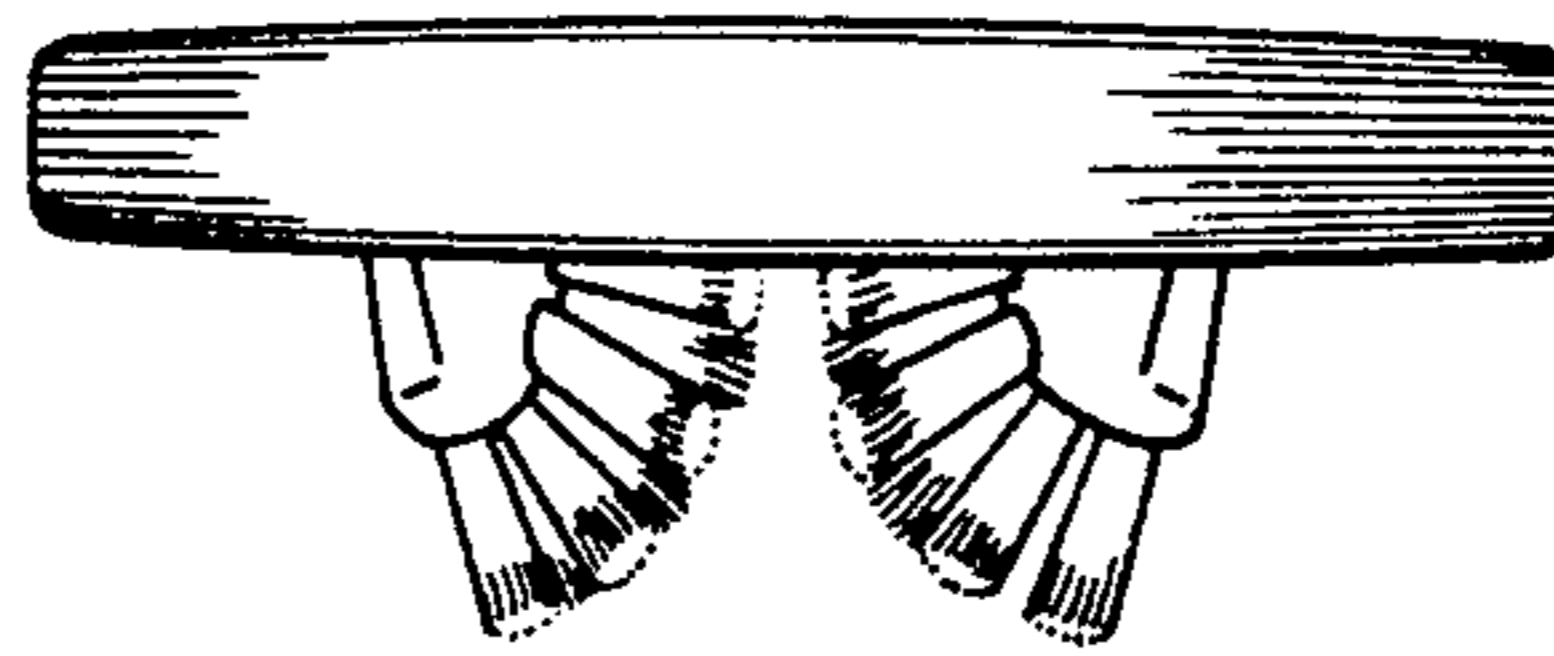

FIG. 5

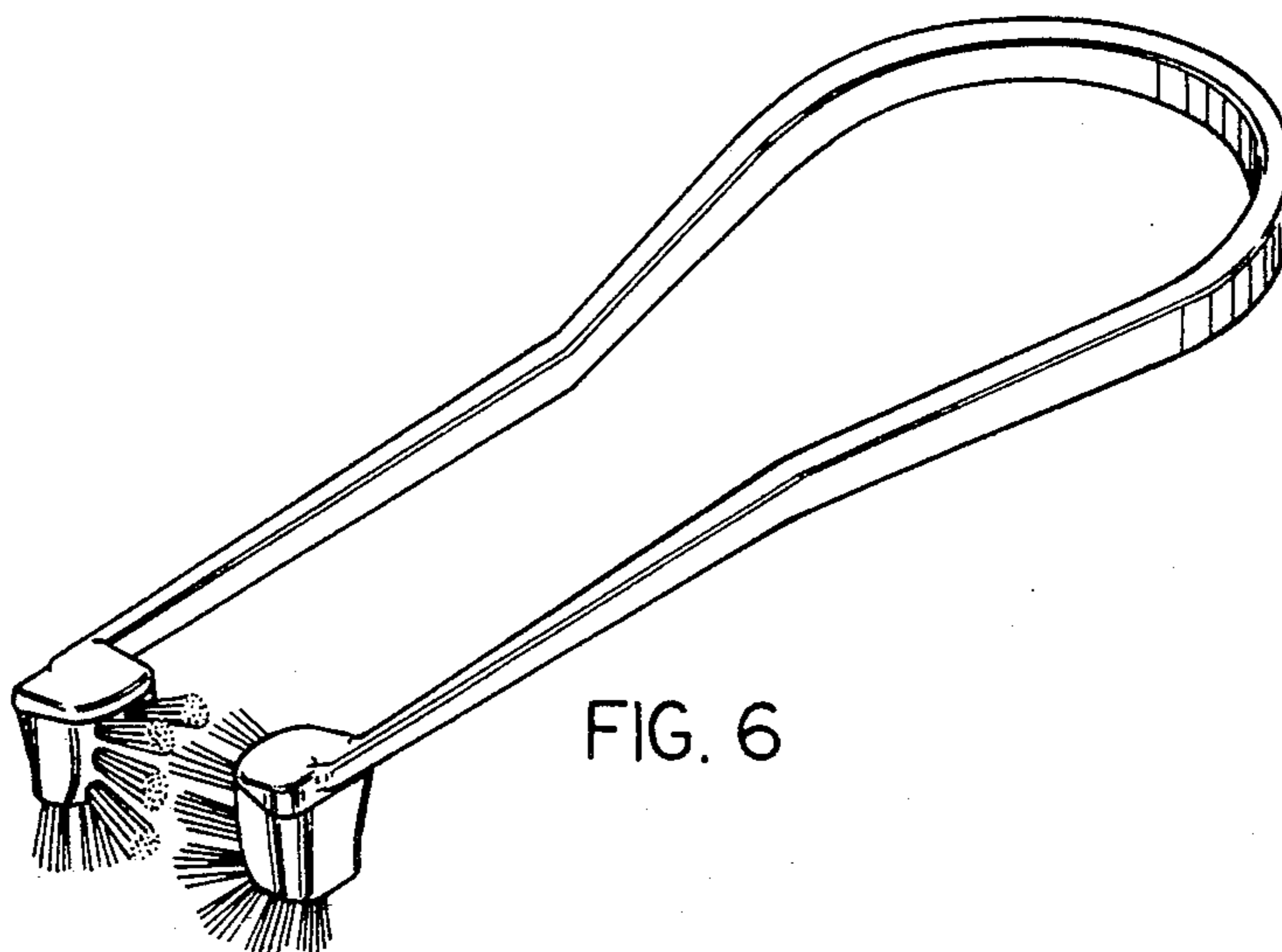

FIG. 6

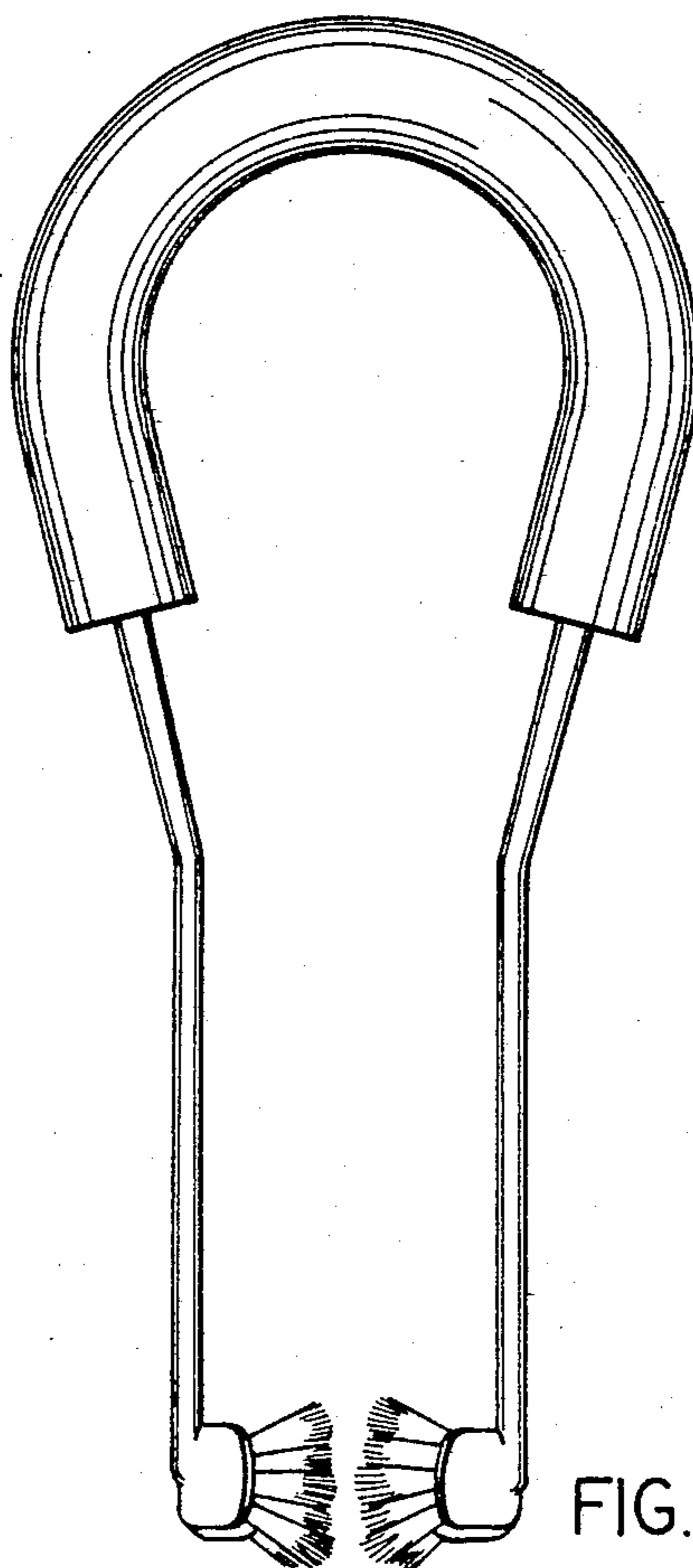

FIG. 7