

[54] TAPE APPLICATOR OR SIMILAR ARTICLE

[75] Inventors: David C. Miller; Robert E. Dawson, both of Ridgefield; Thomas J. Pendelton, North Wilton; Jacob A. Krapowicz, Ridgefield, all of Conn.

[73] Assignee: Wagner Spray Tech Corporation, Minneapolis, Minn.

[**] Term: 14 Years

[21] Appl. No.: 522,969

[22] Filed: Aug. 15, 1983

[52] U.S. Cl. D19/69; D18/19

[58] Field of Search D19/67-69; 225/89, 56, 59; D18/19

[56] References Cited

U.S. PATENT DOCUMENTS

- D. 164,556 9/1951 Donkin D19/69
- D. 183,881 11/1958 Fritzinger D19/67
- D. 225,577 12/1972 Boyce D19/69

- D. 227,810 7/1973 Boyce D19/69
- D. 239,620 4/1976 Fritzinger D19/69

Primary Examiner—George P. Word
Attorney, Agent, or Firm—Hill, Van Santen, Steadman & Simpson

[57] CLAIM

The ornamental design for a tape applicator or similar article, as shown and described.

DESCRIPTION

FIG. 1 is a perspective view of a tape applicator or similar article showing our new design, the environmental structure shown in dotted lines being for illustrative purposes only;

FIG. 2 is a top plan view thereof.

FIG. 3 is a side elevational view thereof.

FIG. 4 is a front elevational view thereof taken from the right hand side of FIG. 3.

FIG. 5 is a rear elevational view thereof taken from the left hand side of FIG. 3; and

FIG. 6 is a bottom plan view thereof.

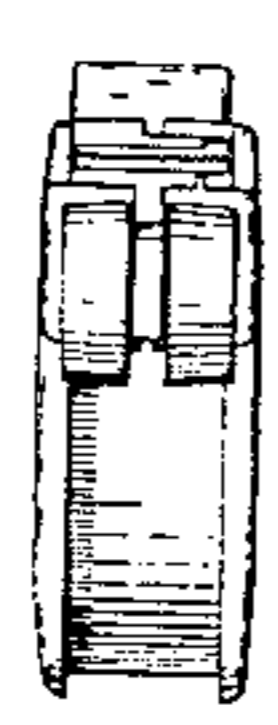
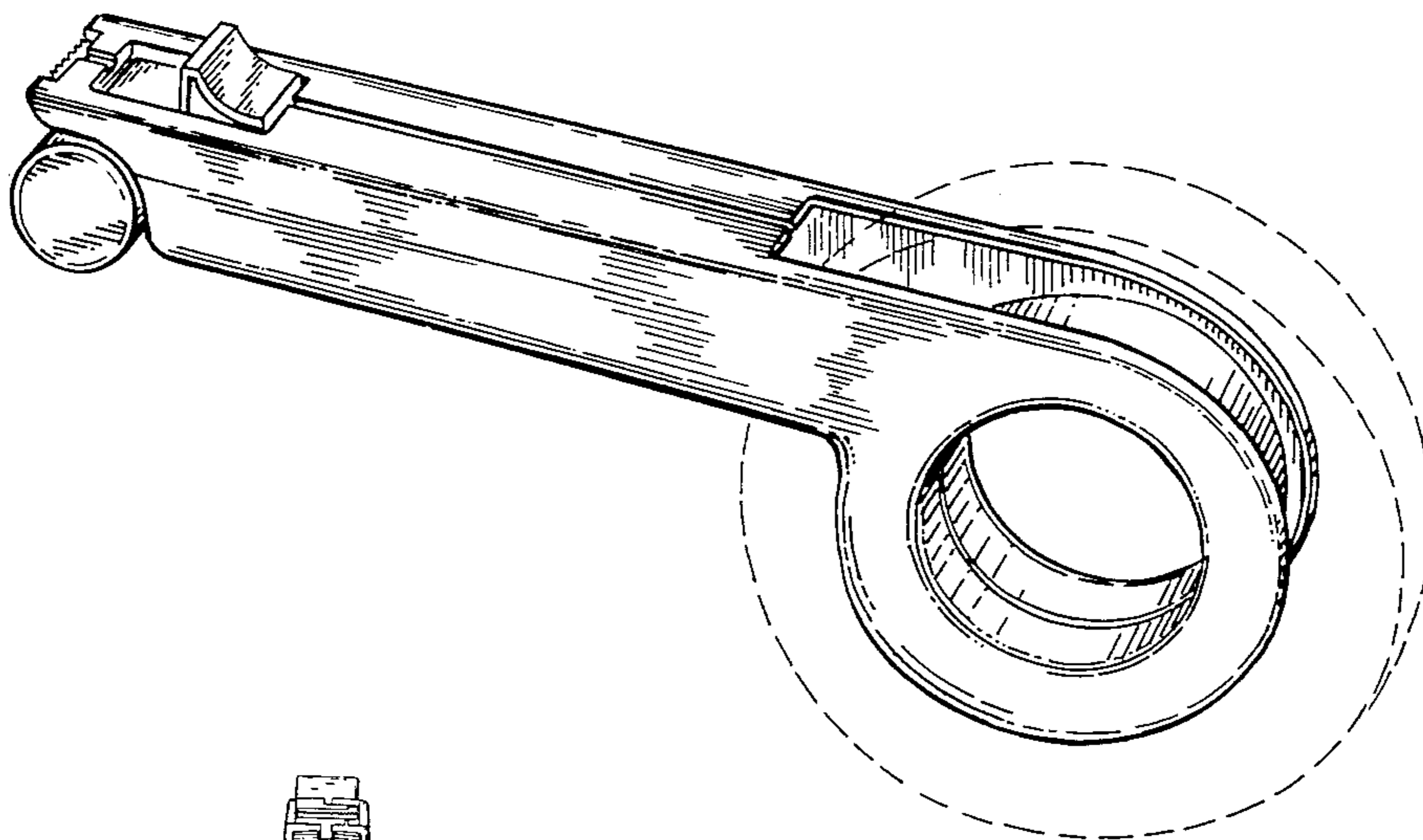

FIG. 1

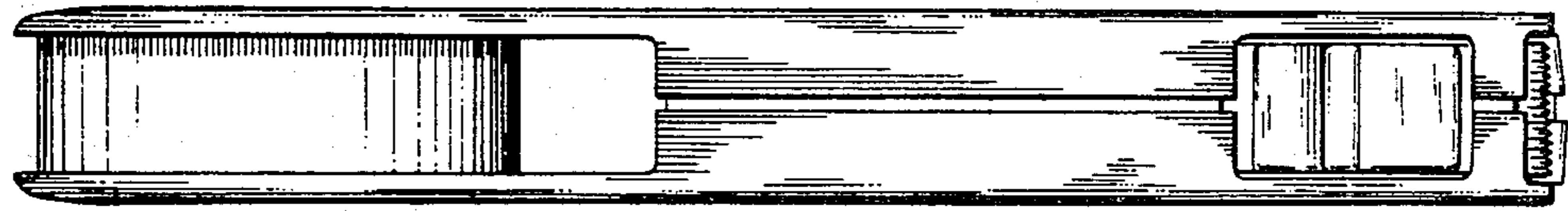
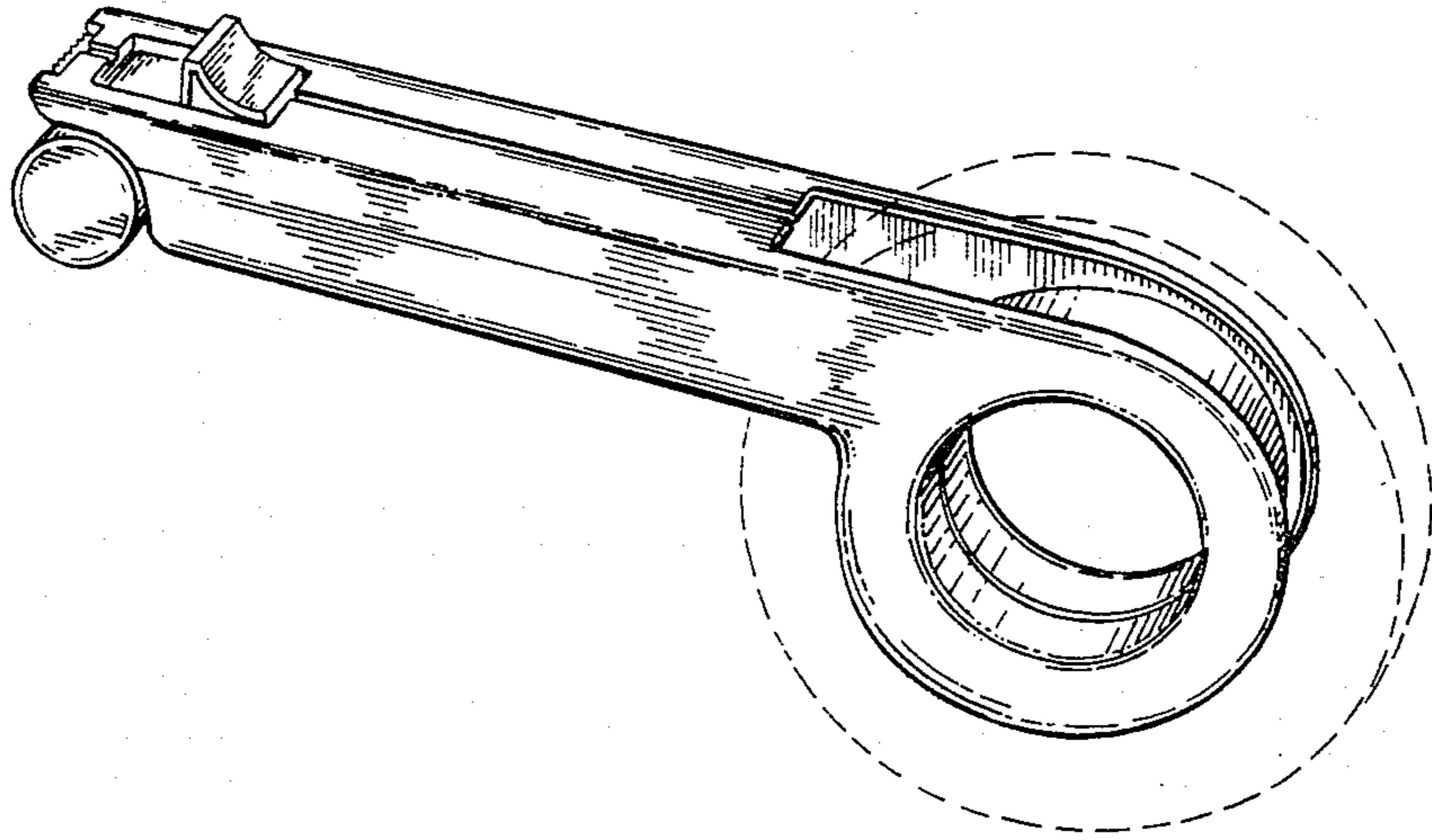

FIG. 2

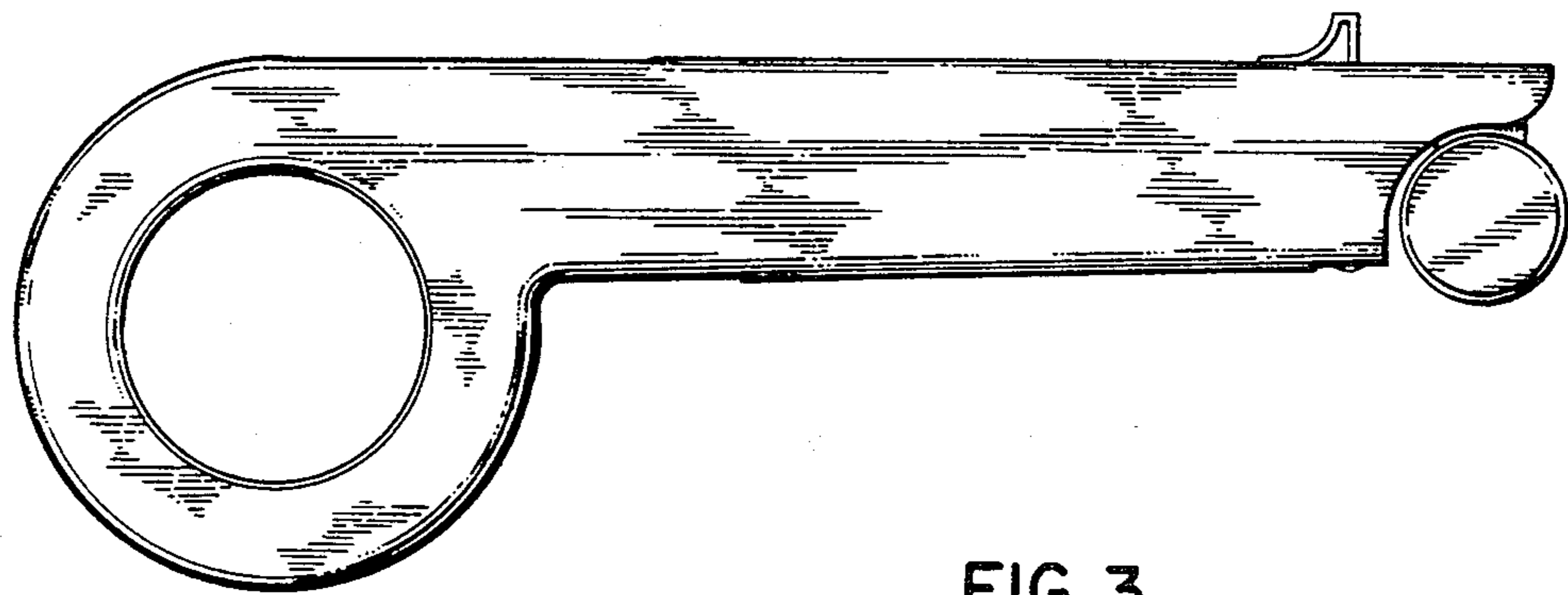

FIG. 3

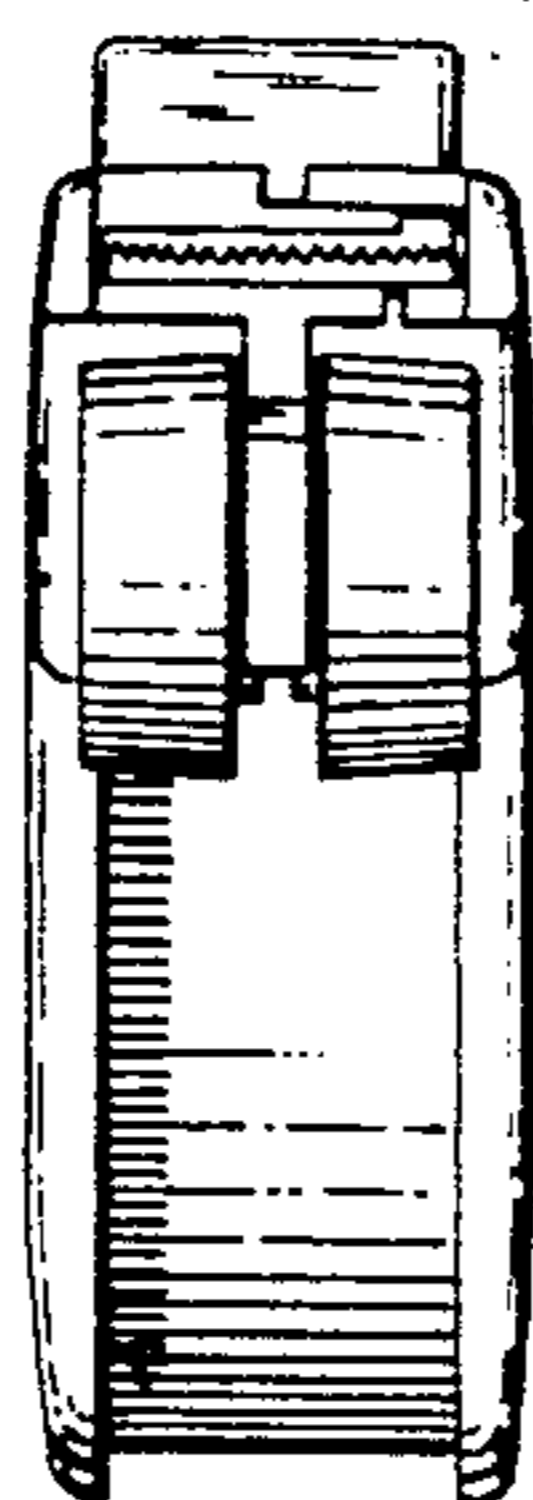

FIG. 4

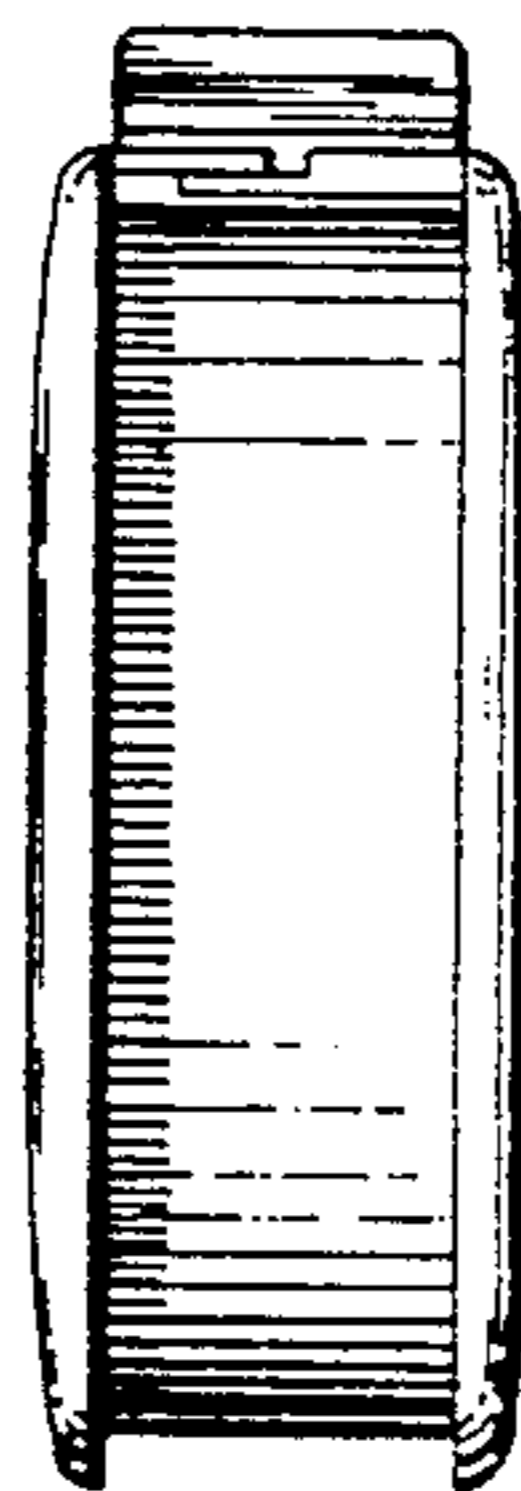

FIG. 5

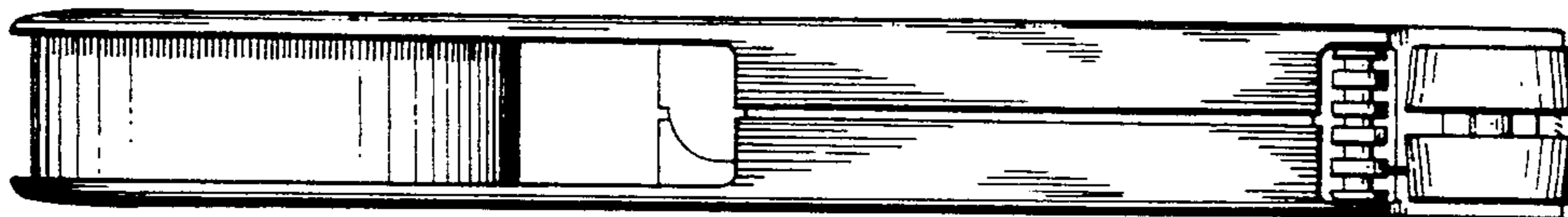

FIG. 6