

[54] SHOWCASE

[75] Inventor: Robert G. Harig, Paragould, Ark.

[73] Assignee: Darling Store Fixtures, Paragould, Ark.

[**] Term: 14 Years

[21] Appl. No.: 489,097

[22] Filed: Apr. 27, 1983

[52] U.S. Cl. D6/470

[58] Field of Search D6/474, 471, 472, 432, D6/436, 470; 312/114, 117

[56] References Cited

U.S. PATENT DOCUMENTS

D. 33,867	1/1901	DeLisle	D6/470
D. 172,795	8/1954	Kaufman	D6/471
D. 209,768	1/1968	Rasmussen	D6/470 X
D. 247,079	1/1978	Ofema	D6/470 X
845,652	2/1907	LaBerge	312/114 X

OTHER PUBLICATIONS

"Display Fixtures a Specification Guide" by Lozier Store Fixtures, p. 11, Framed Series Showcase A, bottom left of page.

Primary Examiner—Carmen H. Vales
Attorney, Agent, or Firm—Emch, Schaffer, Schaub & Porcello Co.

[57] CLAIM

The ornamental design for a showcase, substantially as shown and described.

DESCRIPTION

FIG. 1 is a perspective view of a showcase showing my new design.

FIG. 2 is a left side elevational view thereof.

FIG. 3 is a front elevational view thereof.

FIG. 4 is a rear elevational view thereof.

FIG. 5 is a top plan view thereof; and

FIG. 6 is a bottom plan view thereof.

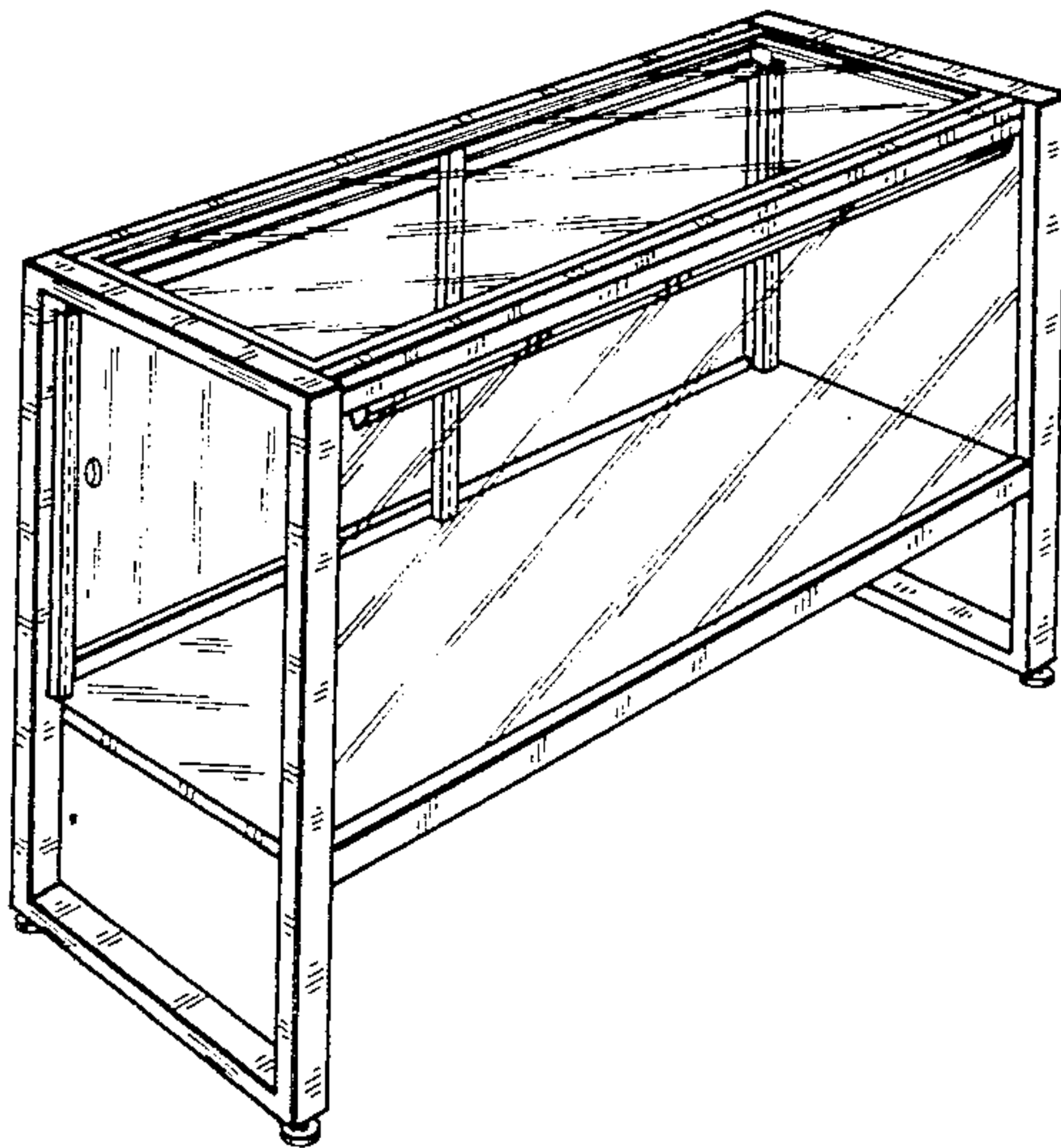

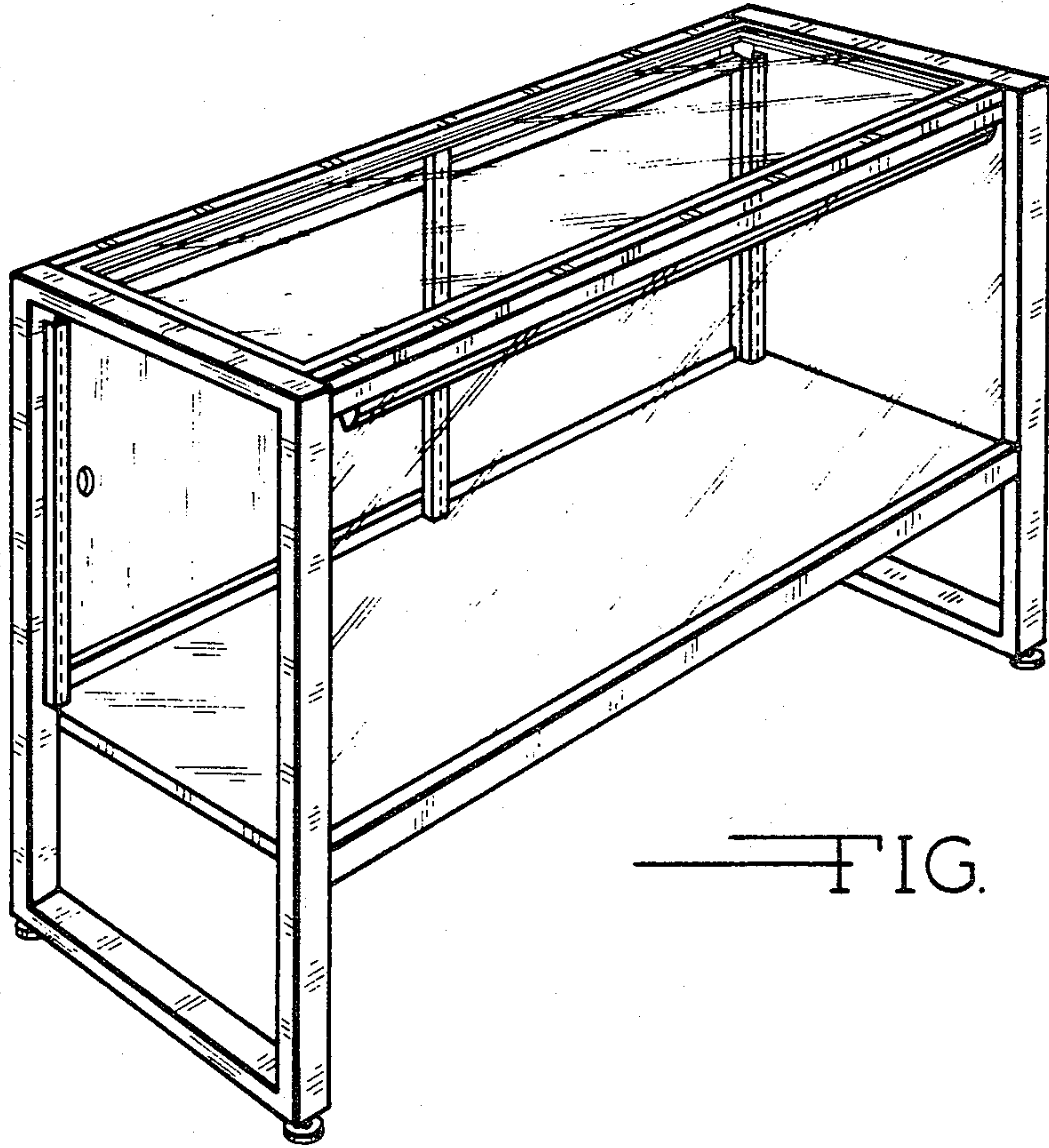

— FIG. 1

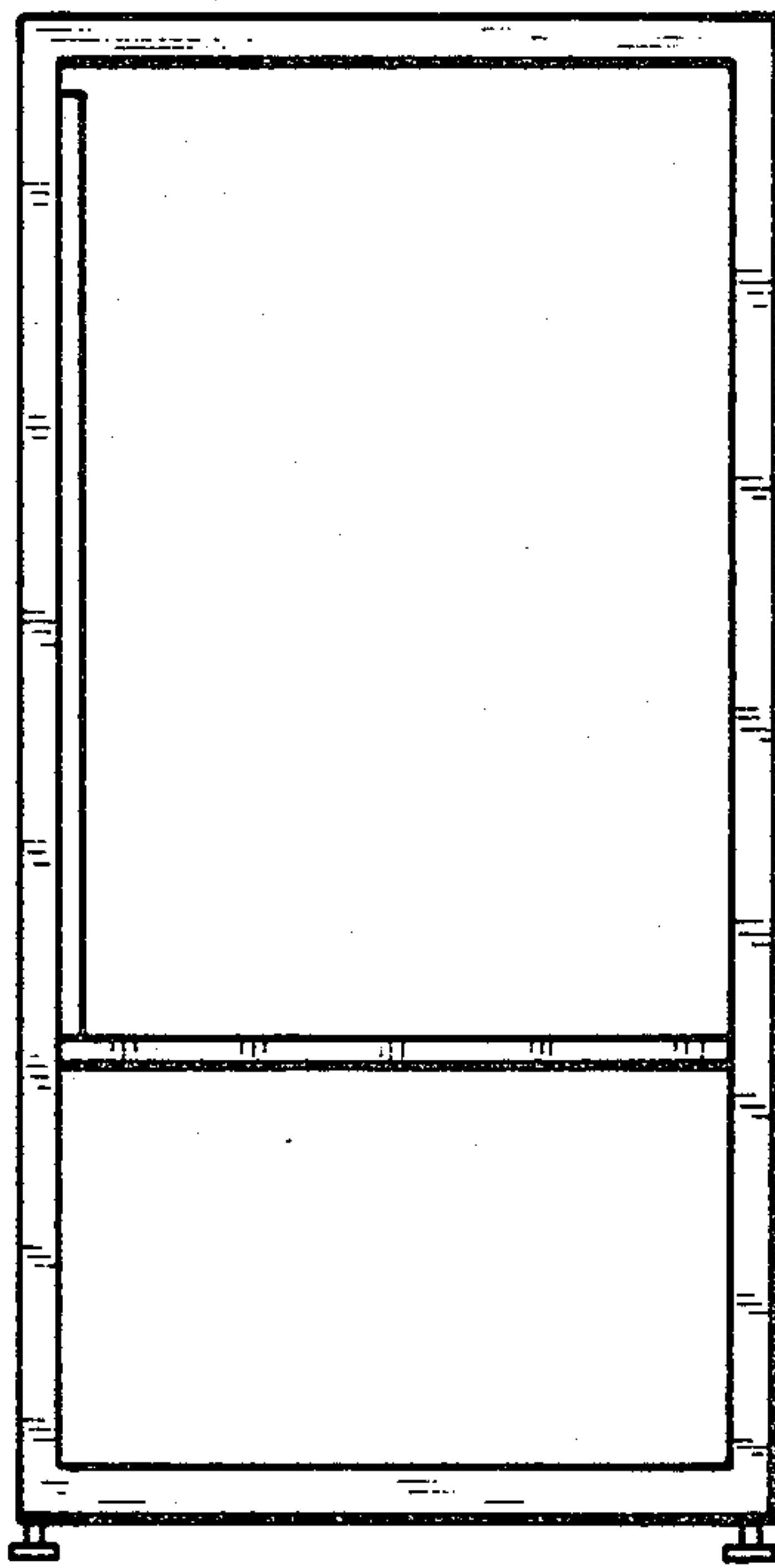

— FIG. 2

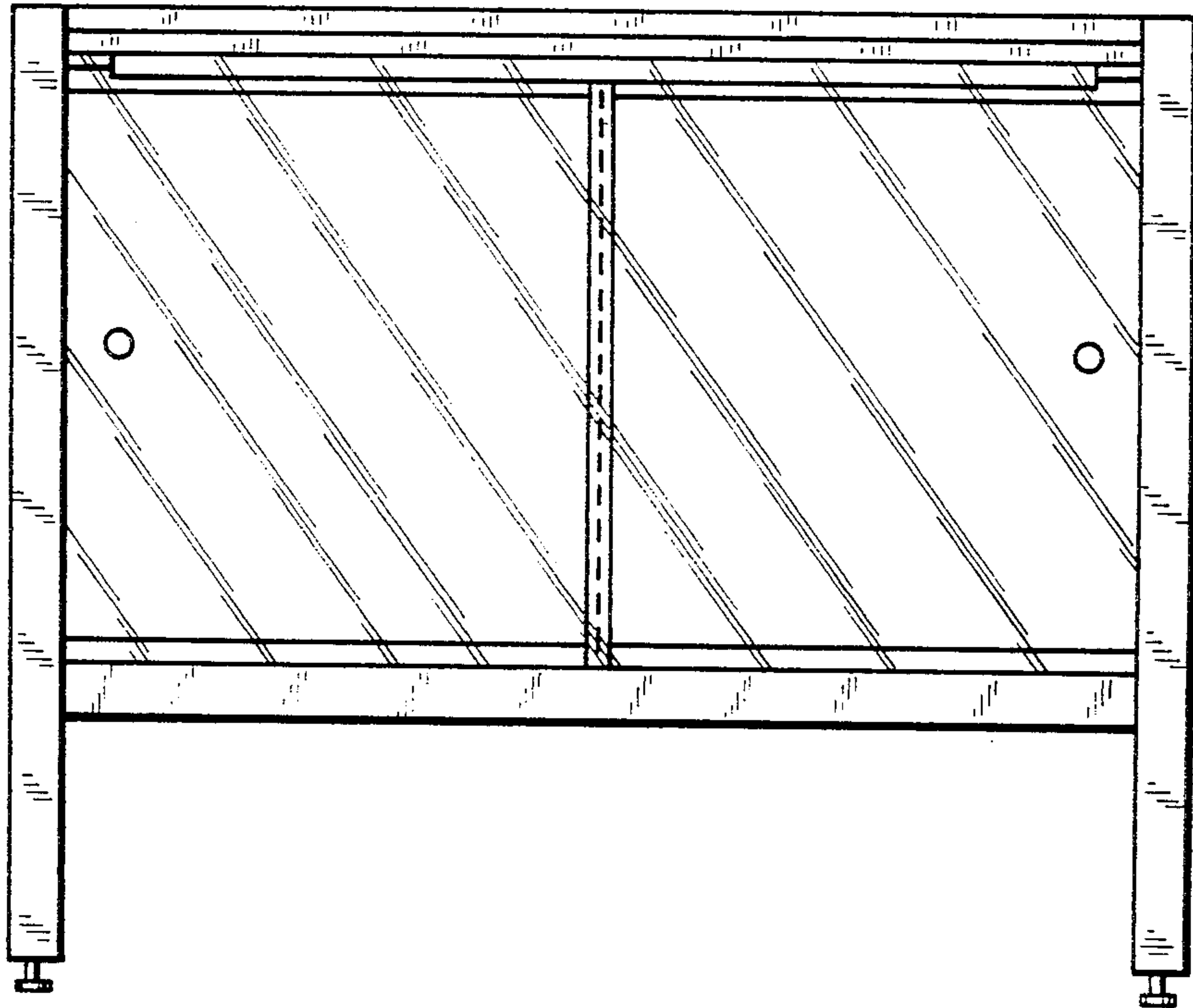

— FIG. 3

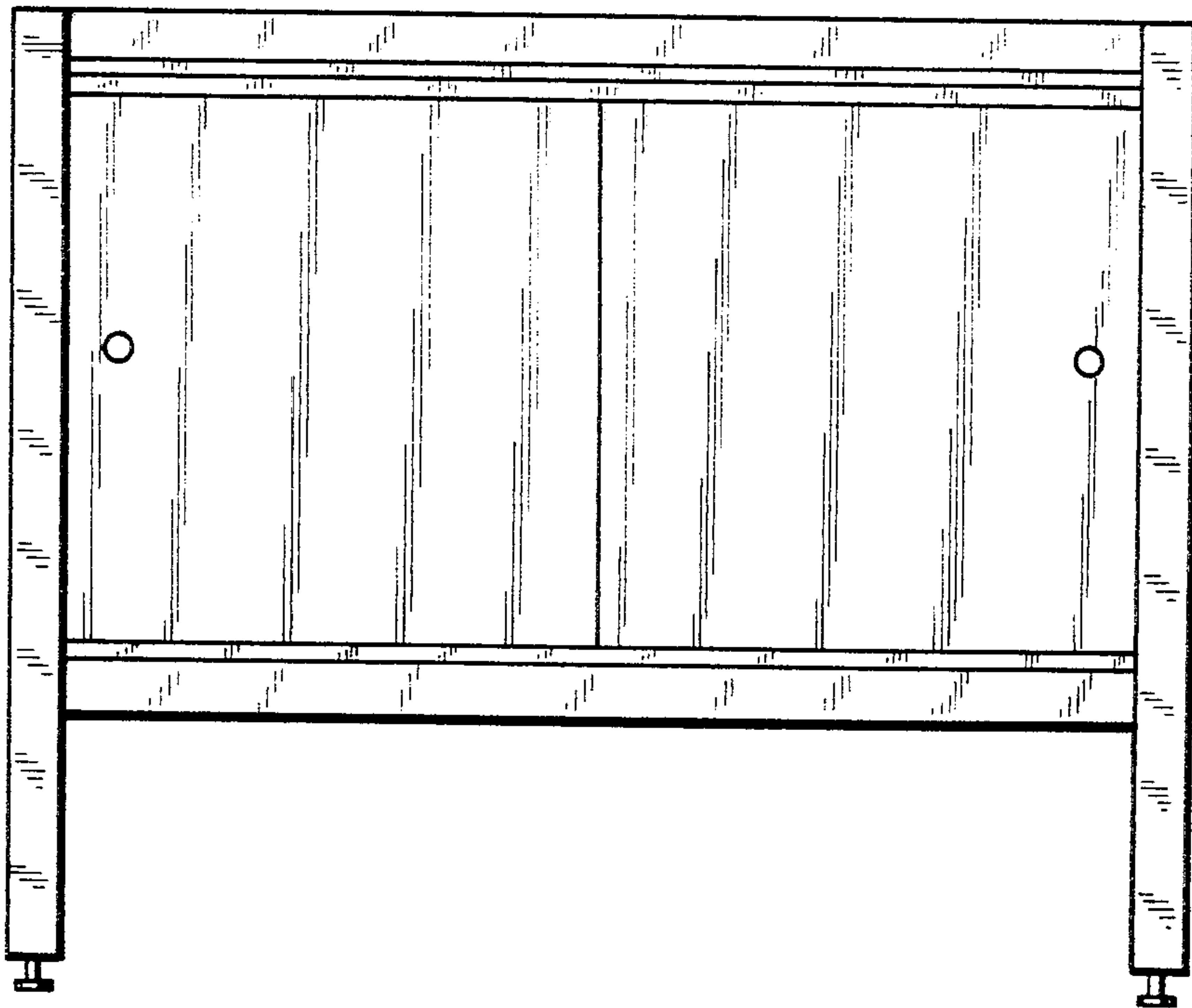

— FIG. 4

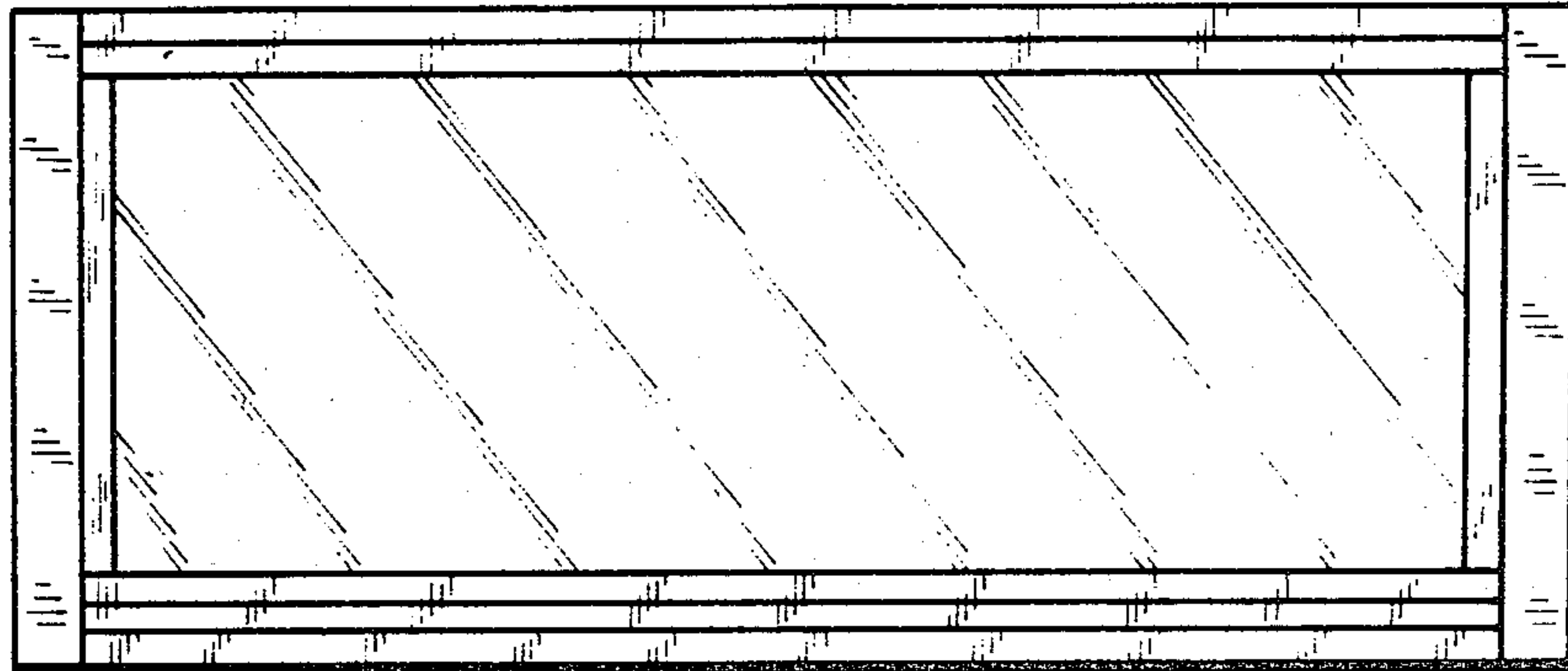

— FIG. 5

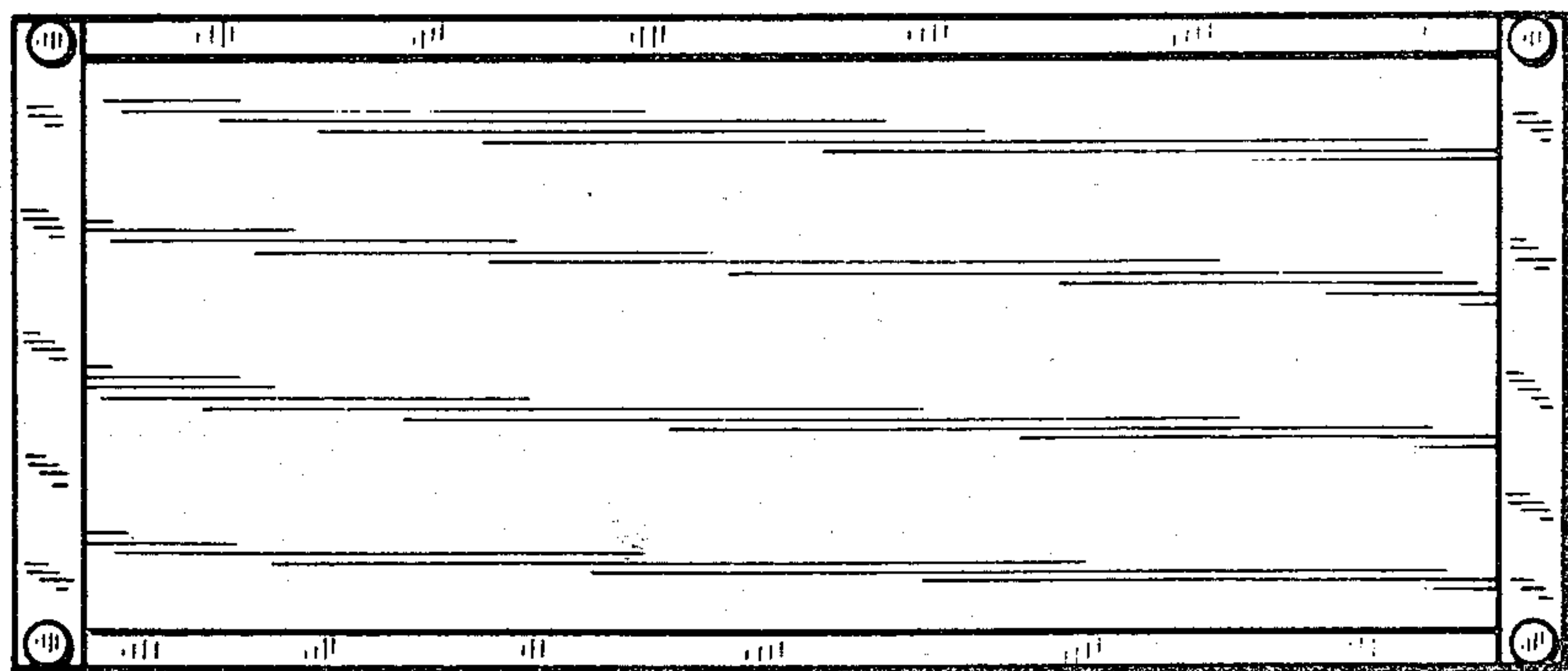

— FIG. 6