

[54] COMPARTMENTED STORAGE BOX FOR STATIONERY ARTICLES OR THE LIKE

[76] Inventor: Kurt Geist, Room 805, Belgian Bank Bldg., 721 Nathan Rd., Kowloon, Hong Kong

[**] Term: 14 Years

[21] Appl. No.: 534,619

[22] Filed: Sep. 22, 1983

[30] Foreign Application Priority Data

Mar. 24, 1983 [GB] United Kingdom 1 012 143

[52] U.S. Cl. D3/74; D3/30.1

[58] Field of Search 206/214, 1.7, 1.8; D3/30.1, 39, 74, 75, 78; D19/75

[56] References Cited

U.S. PATENT DOCUMENTS

- D. 216,928 3/1970 Olson D3/74
- D. 224,071 6/1972 Hatibovich D3/39
- D. 264,232 5/1982 Lang D3/74
- D. 273,427 4/1984 Barradas D3/74

- 2,105,163 1/1938 Scandore 206/214
- 2,446,896 8/1948 Wellman 206/214
- 2,515,703 7/1950 Dumas 206/1.8
- 2,637,299 5/1953 Salkey 206/214

Primary Examiner—George P. Word
Attorney, Agent, or Firm—Wenderoth, Lind & Ponack

[57] CLAIM

The ornamental design for a compartmental storage box for stationery articles or the like, as shown and described.

DESCRIPTION

FIG. 1 is a front perspective view of a compartmented storage box for stationery articles or the like showing my new design;

FIG. 2 is a right side elevational view thereof;

FIG. 3 is a bottom plan view thereof;

FIG. 4 is a rear elevational view thereof;

FIG. 5 is a perspective view thereof from above and the rear showing the lid open; and

FIG. 6 is a view similar to FIG. 5 but showing the compartments in alternative positions.

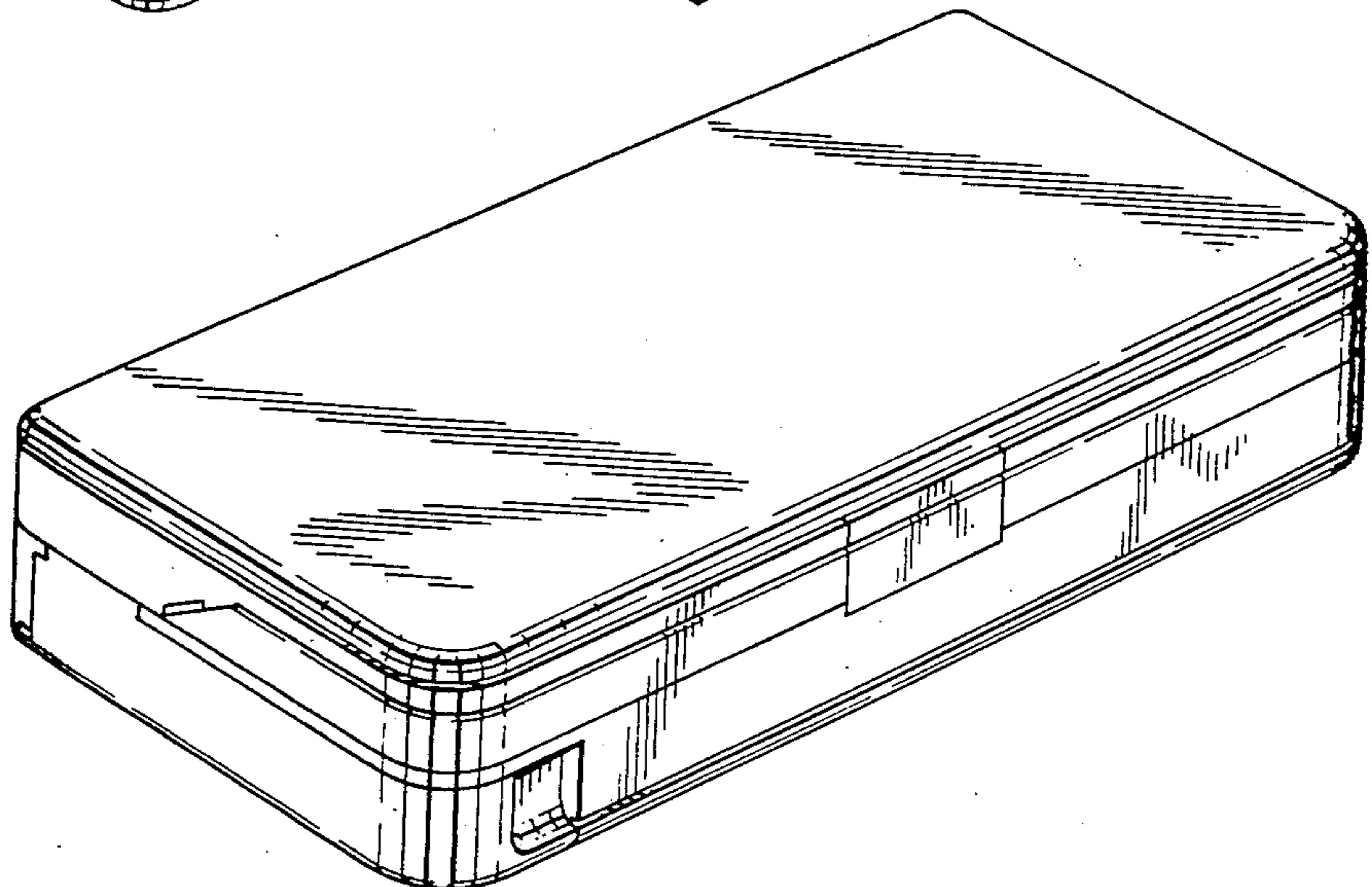
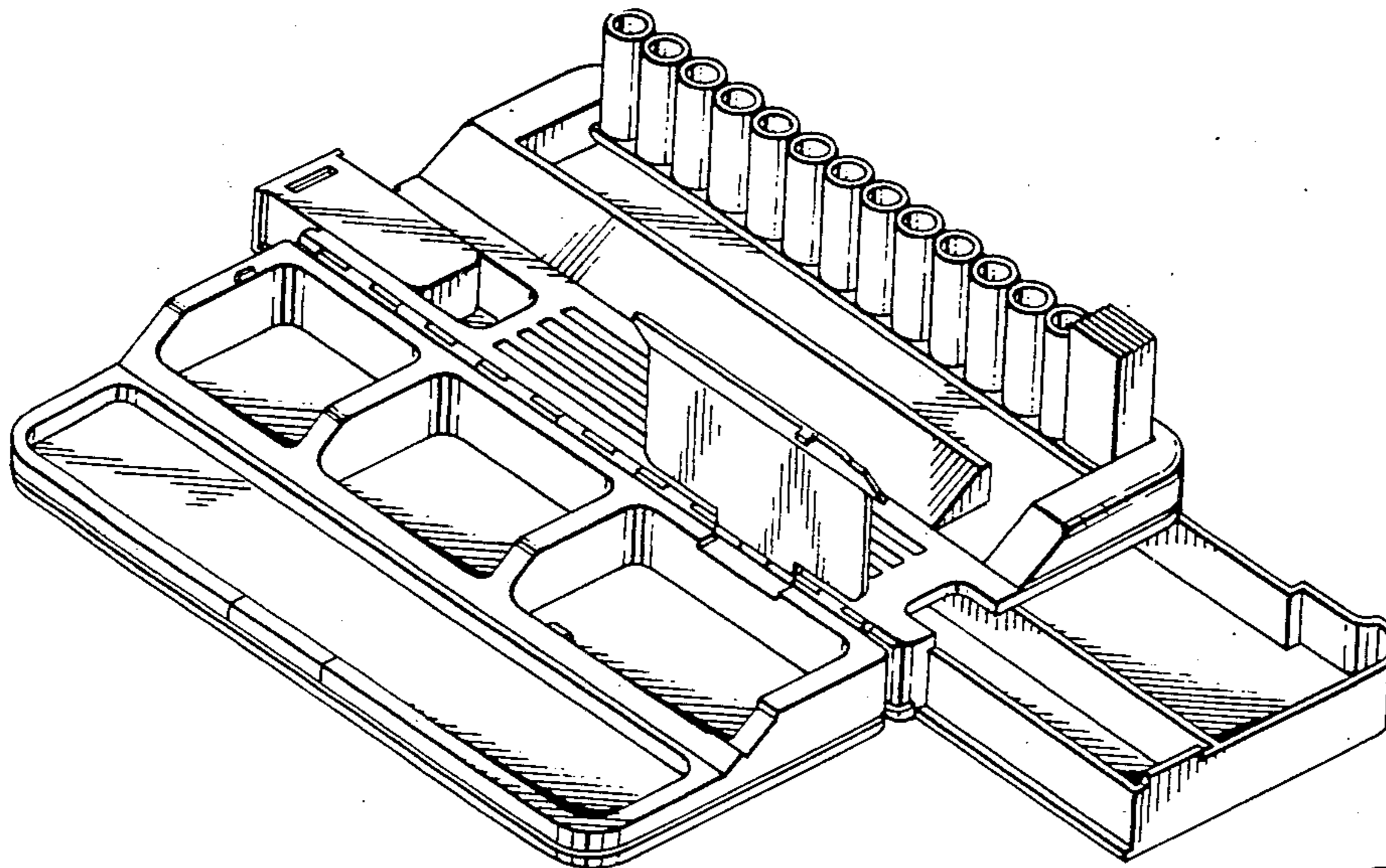

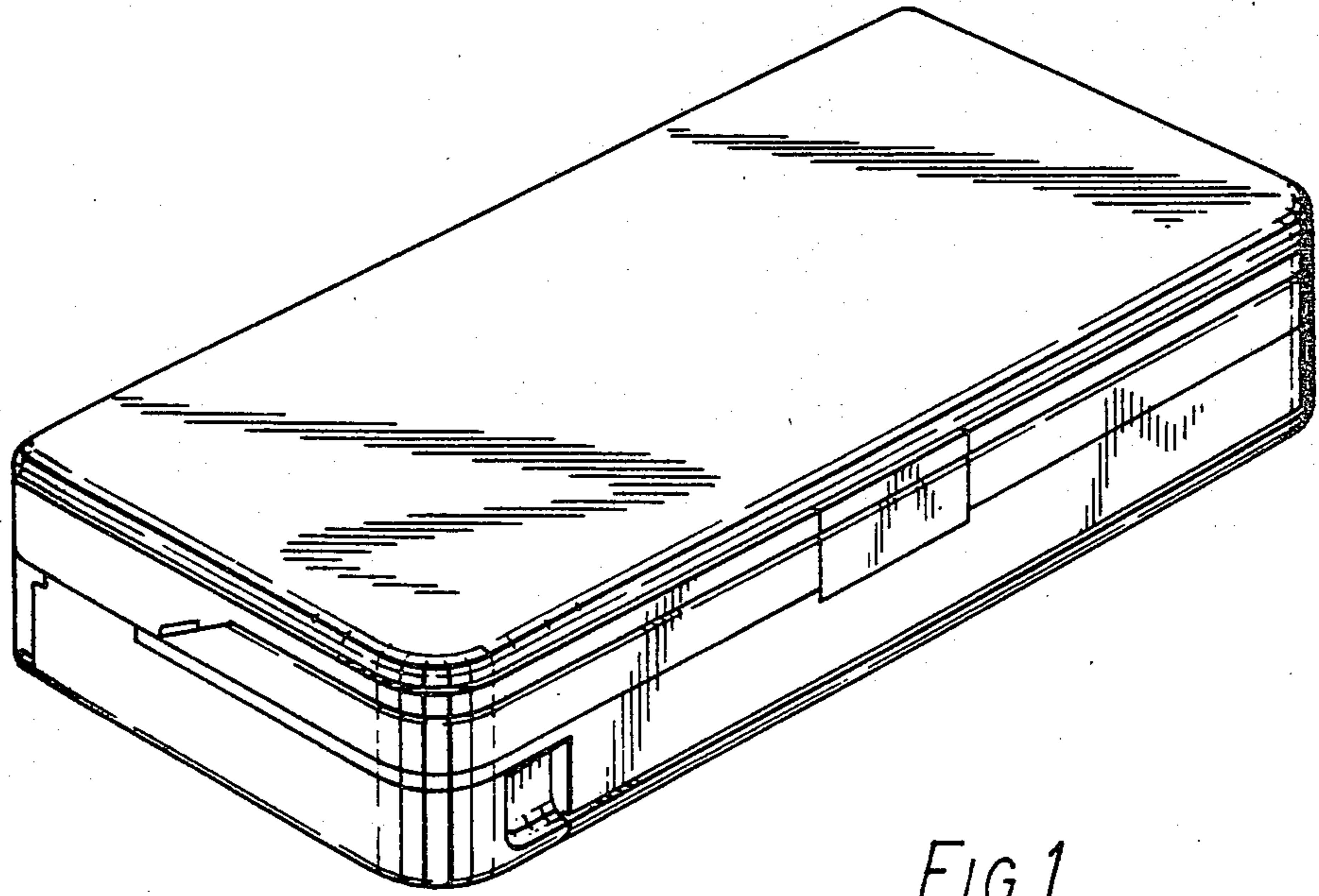

FIG. 1

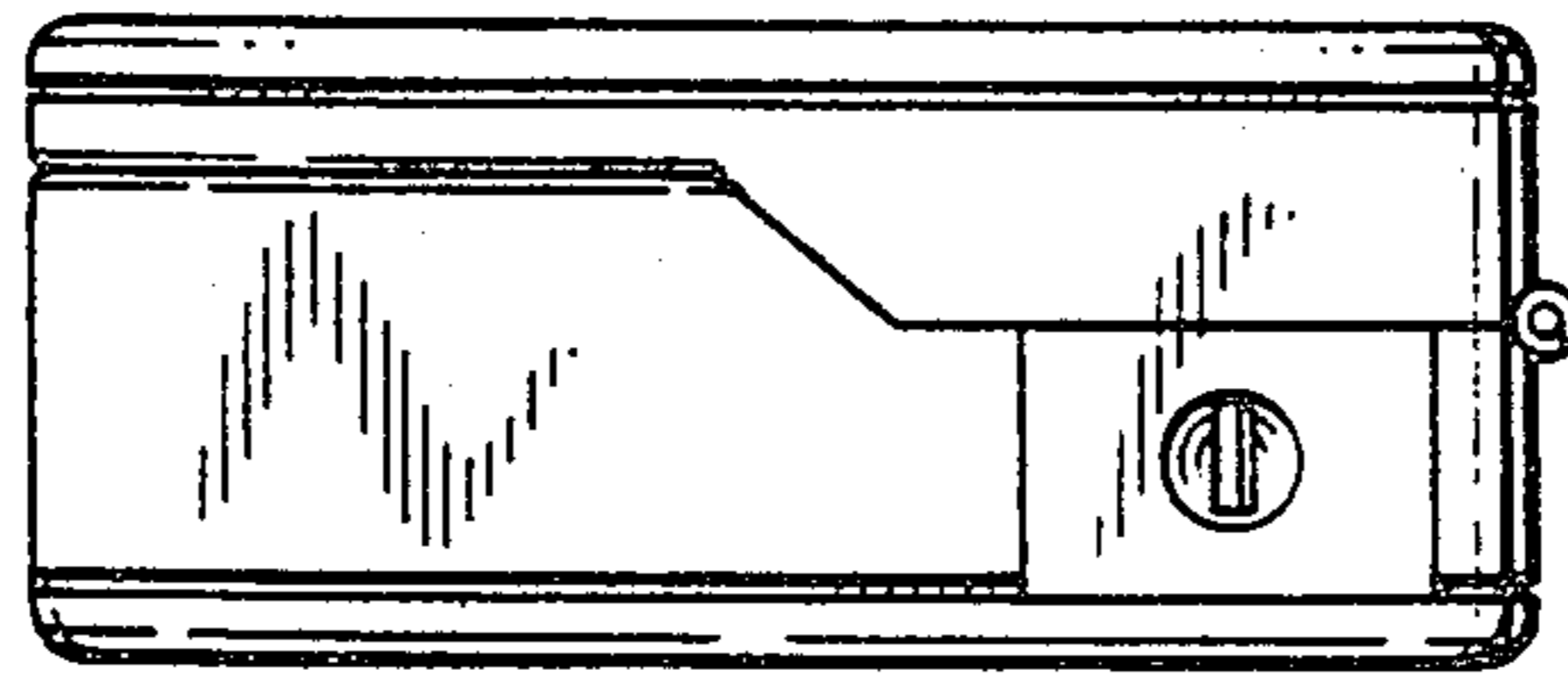

FIG. 2

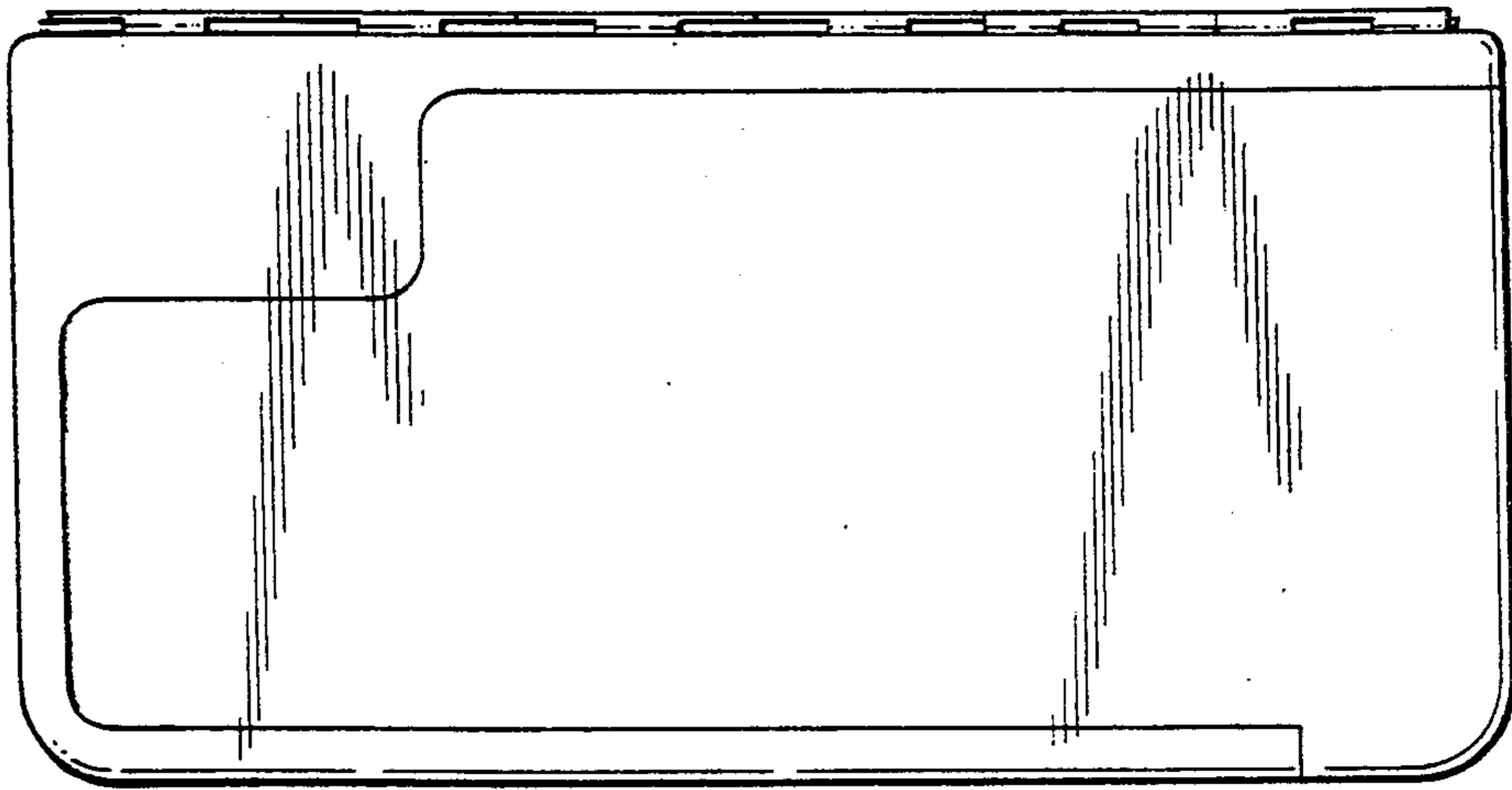

FIG. 3

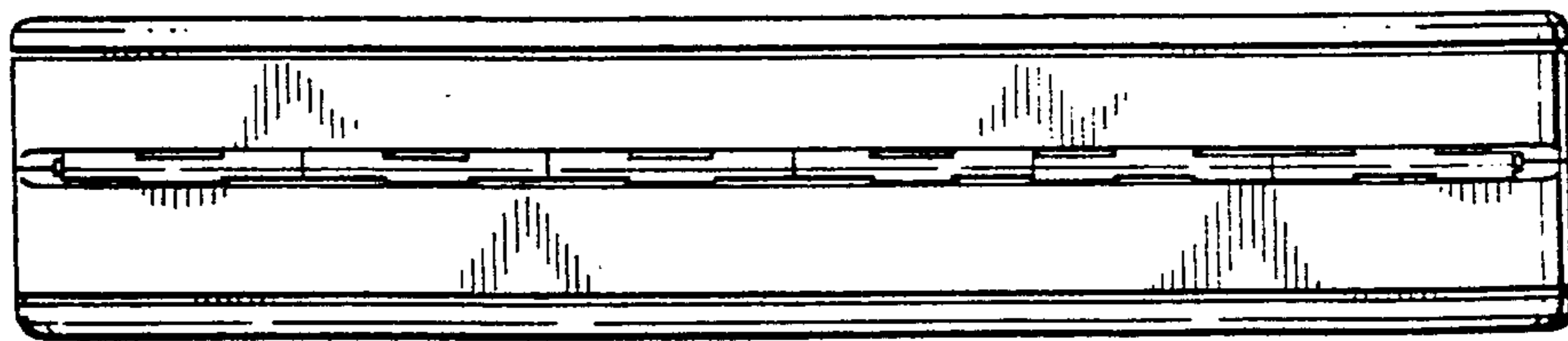

FIG. 4

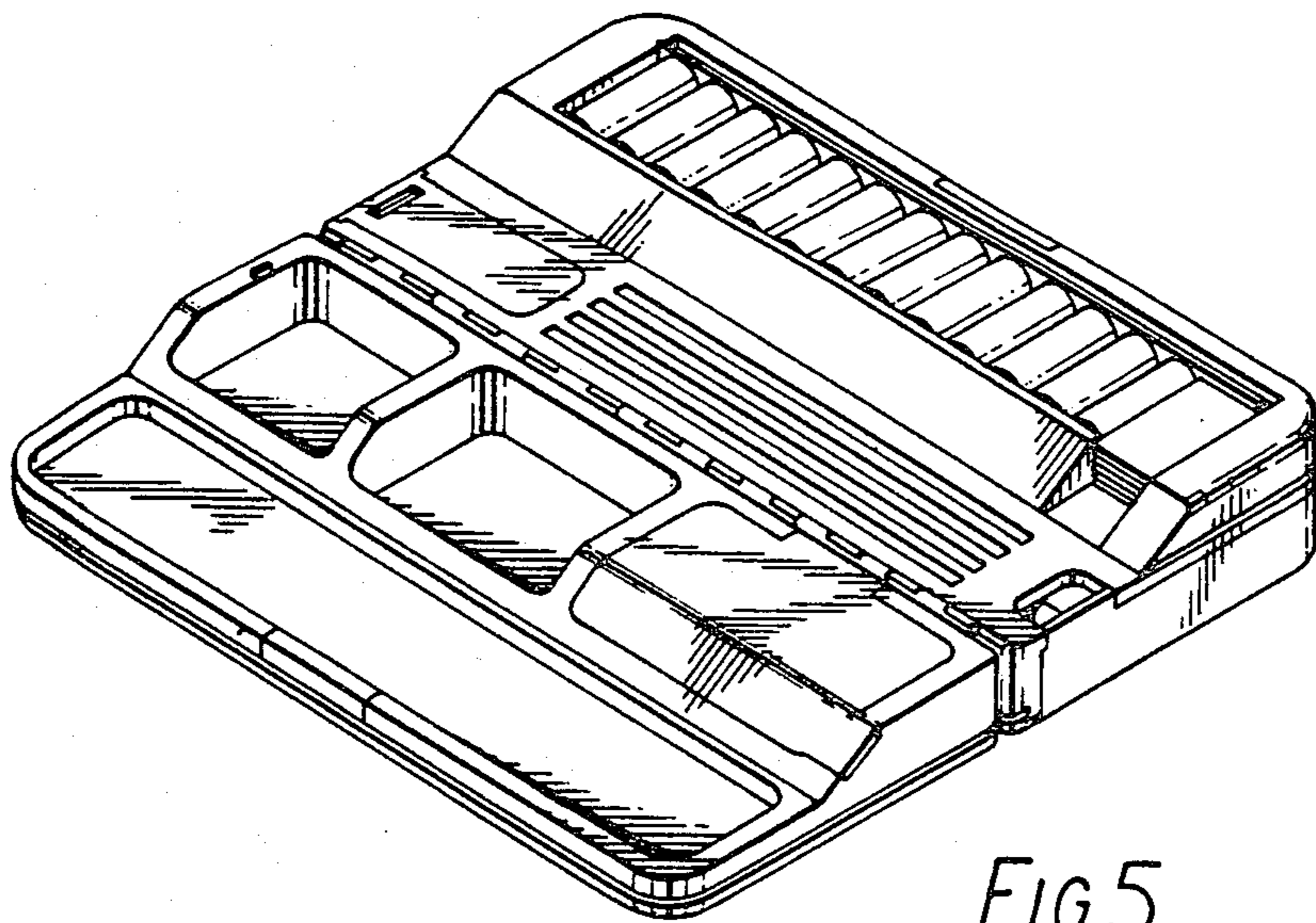

FIG. 5

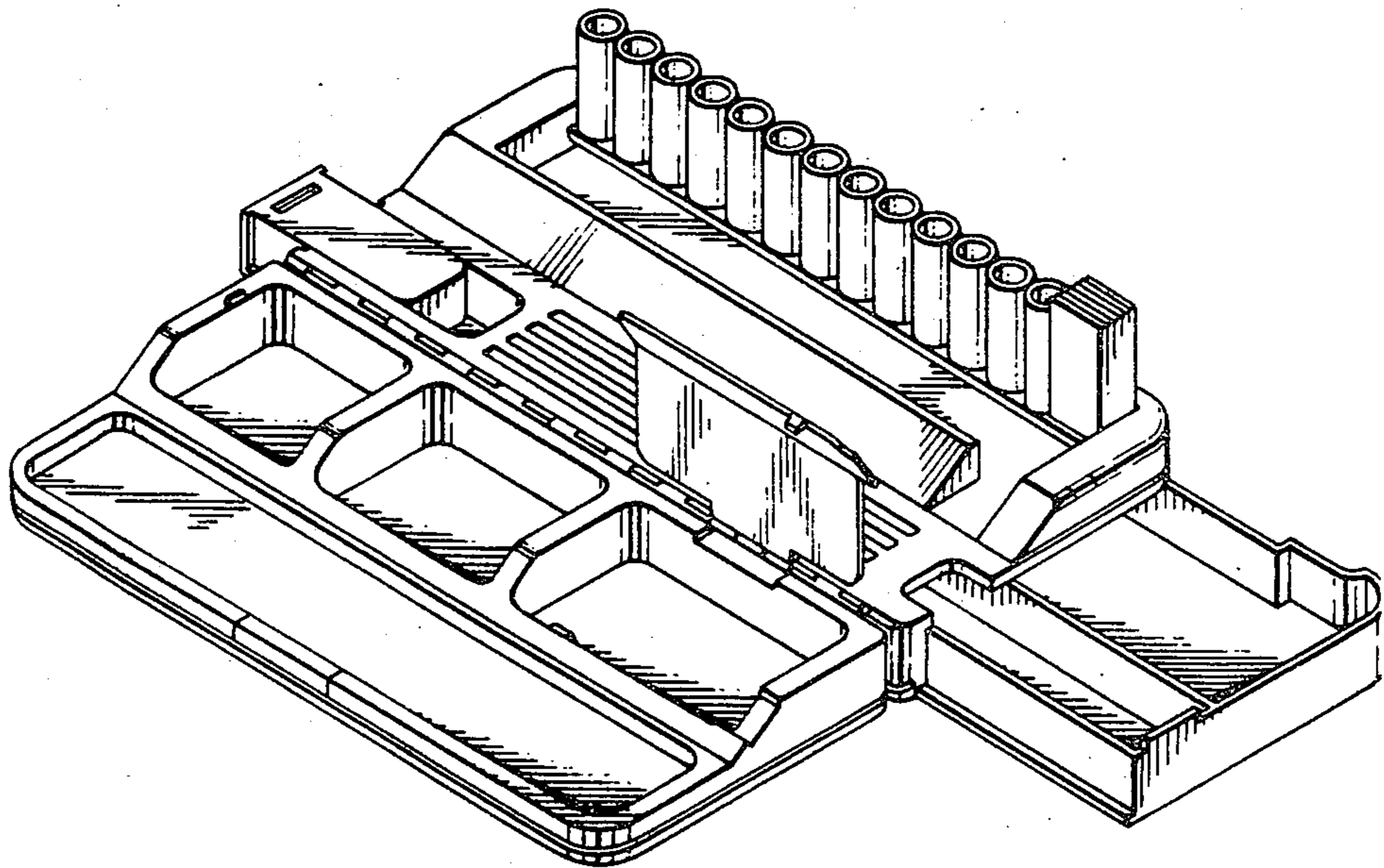

FIG. 6