

[54] CIGAR PIERCER

[76] Inventor: Ed Kolpin, 2729 Wilshire Blvd., Santa Monica, Calif. 90403

[\*\*] Term: 14 Years

[21] Appl. No.: 634,291

[22] Filed: Jul. 25, 1984

[52] U.S. Cl. .... D27/51

[58] Field of Search ..... D27/51; 131/188, 233, 131/248, 252-255, 329

[56] References Cited

U.S. PATENT DOCUMENTS

223,020	12/1879	Wight	131/253
D. 254,811	4/1980	Katz	D27/51
297,956	4/1884	Ungerer	131/255
1,177,852	4/1916	Flanders	131/254
1,376,335	4/1921	Hentschel	131/254
1,434,599	11/1922	Field et al.	131/255
1,892,429	12/1932	Frankel	131/254

FOREIGN PATENT DOCUMENTS

329862	9/1935	Italy	131/254
22606	of 1905	United Kingdom	131/255
2809	of 1911	United Kingdom	131/188

Primary Examiner—Catherine E. Kemper  
Attorney, Agent, or Firm—John E. Kelly

[57] CLAIM

The ornamental design for a cigar piercer, substantially as shown.

DESCRIPTION

FIG. 1 is a perspective view of a cigar piercer showing my new design;  
 FIG. 2 is a perspective view thereof, showing the two sections separated;  
 FIG. 3 is a side elevational view thereof;  
 FIG. 4 is a top view thereof;  
 FIG. 5 is a side elevational view thereof, showing the two sections separated;  
 FIG. 6 is a top elevational view thereof, showing the two sections separated;  
 FIG. 7 is a left side elevational view thereof; and,  
 FIG. 8 is a right side elevational view thereof.

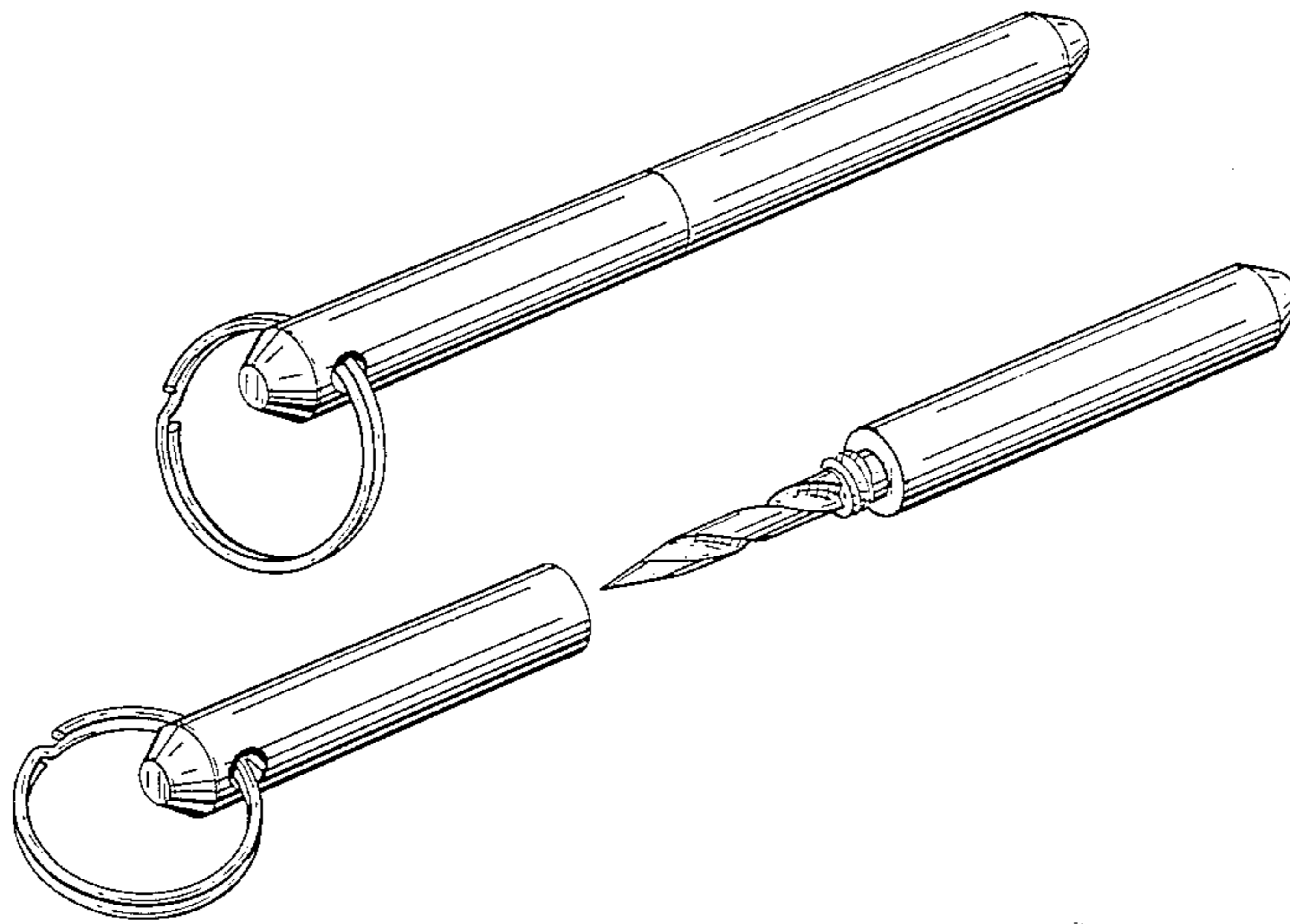

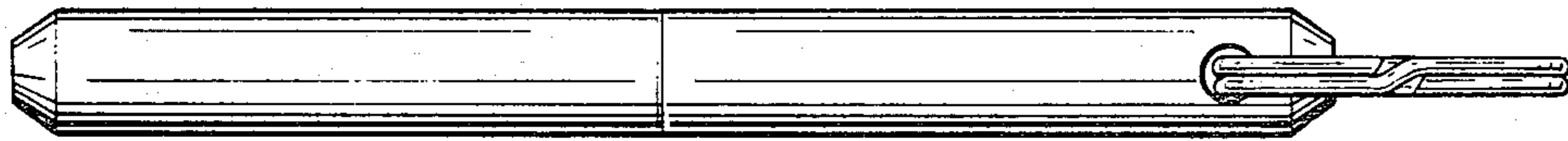
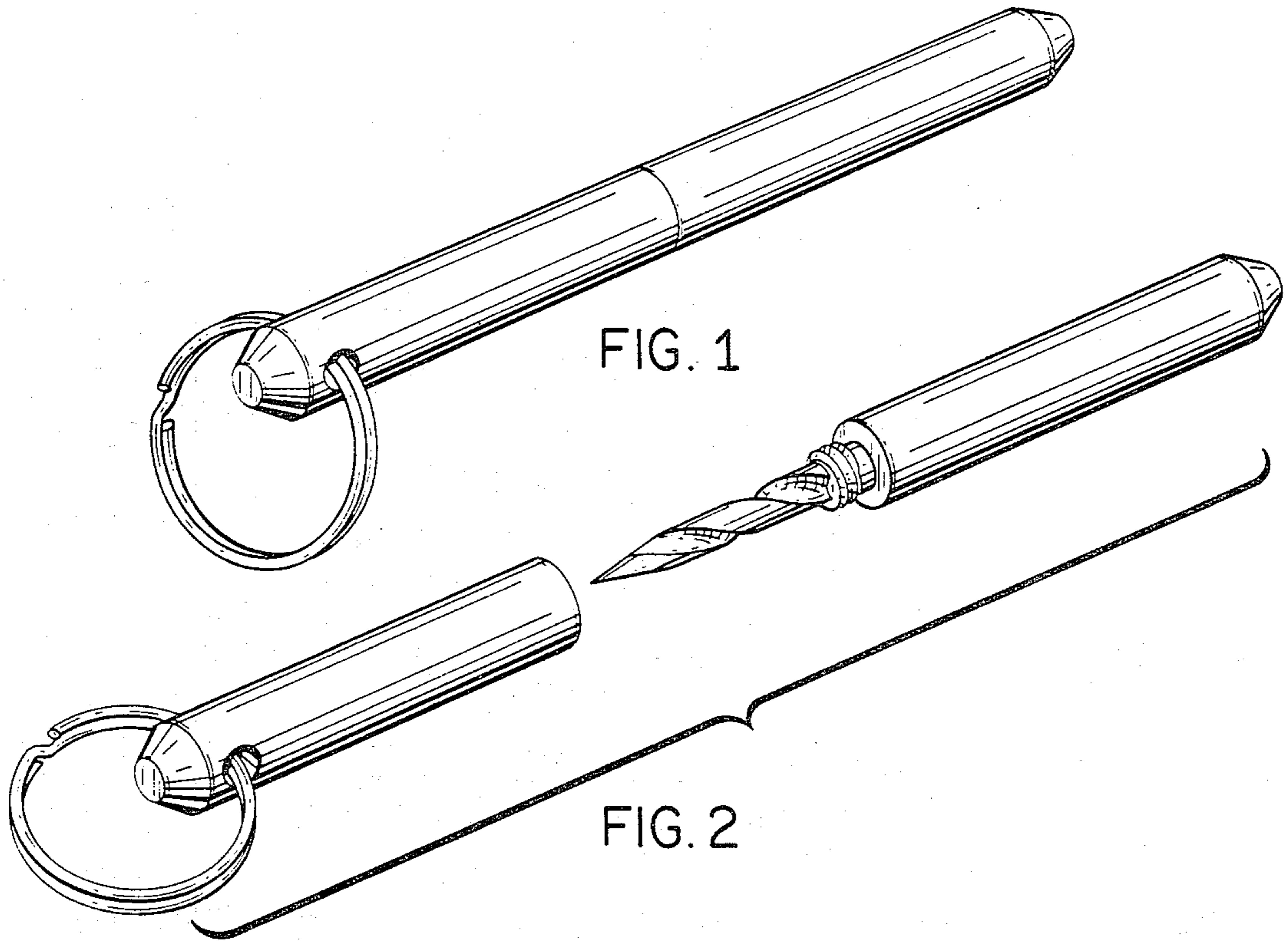

FIG. 3

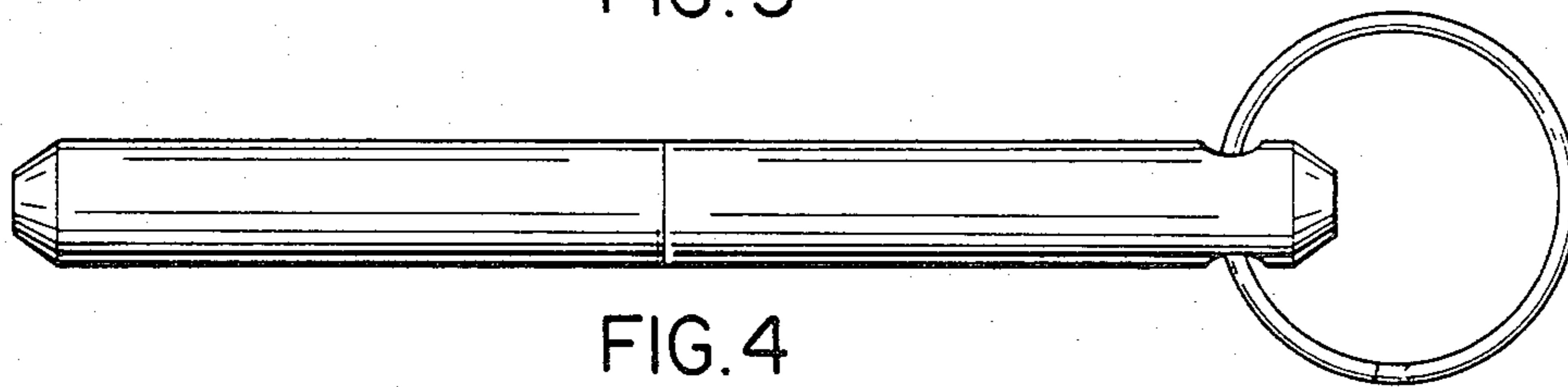

FIG. 4

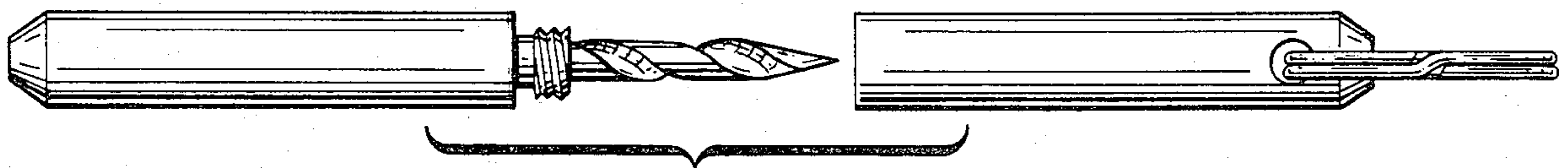

FIG. 5

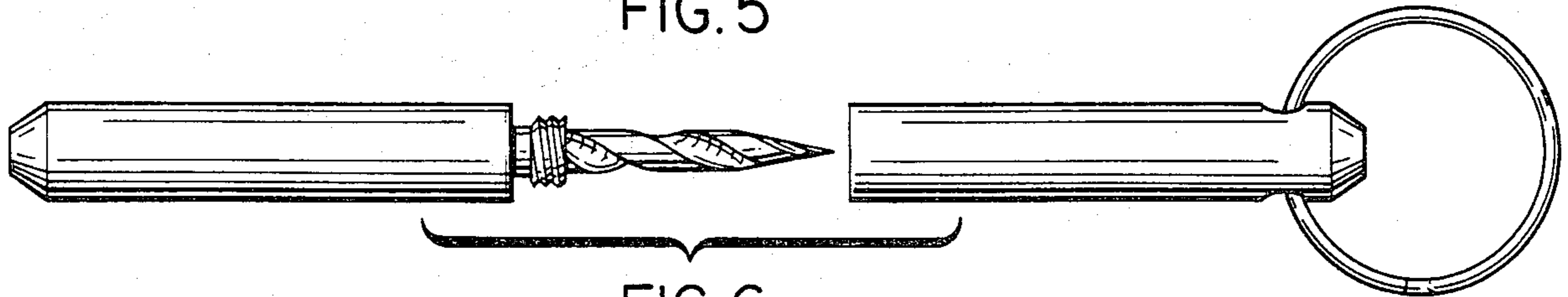

FIG. 6

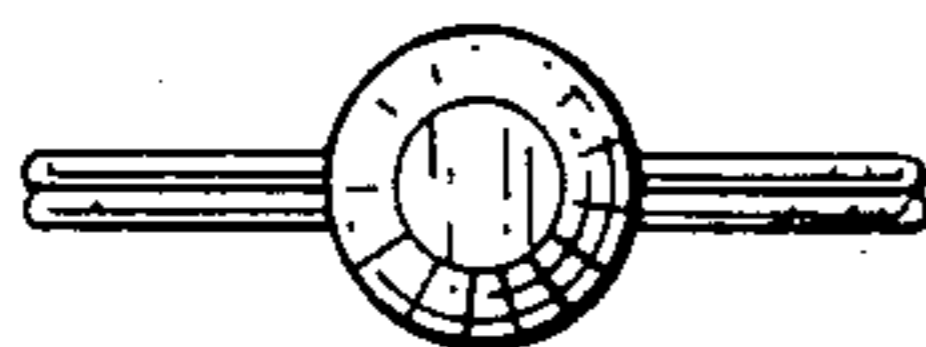

FIG. 7

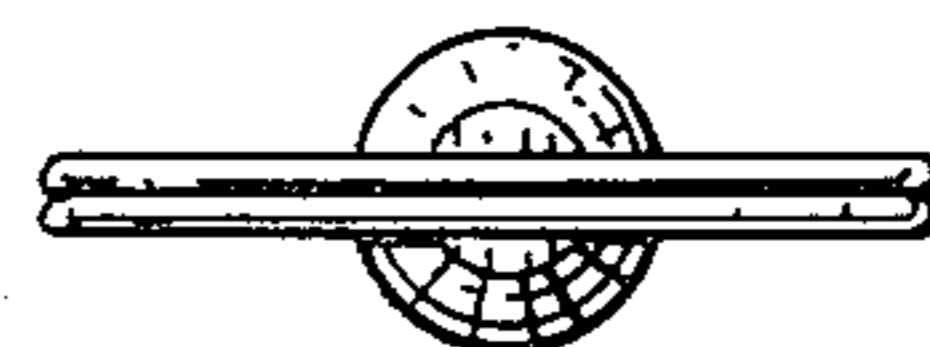

FIG. 8