

[54] WELL POINT SYSTEM TANK

[76] Inventor: Albert H. Sloan, 4201 Kean Rd., Fort Lauderdale, Fla. 33314

[**] Term: 14 Years

[21] Appl. No.: 512,240

[22] Filed: Jul. 11, 1983

[52] U.S. Cl. D15/7

[58] Field of Search D15/7, 9; 417/40, 46, 417/200, 202

[56] References Cited

U.S. PATENT DOCUMENTS

2,927,174	3/1960	Walshin	417/40
2,930,867	3/1960	Nash	417/40
3,005,068	10/1961	Pollack	417/40
4,029,438	6/1977	Sloan	417/200

Primary Examiner—Wallace R. Burke
Assistant Examiner—Lynn Wilder
Attorney, Agent, or Firm—James E. Nilles

[57] CLAIM

The ornamental design for a well point system tank, substantially as shown.

DESCRIPTION

FIG. 1 is a perspective view of a well point system tank showing my new design;
FIG. 2 is a front elevational view thereof;
FIG. 3 is a top plan view thereof;
FIG. 4 is a bottom plan view thereof;
FIG. 5 is a side elevational view taken from the left side of FIG. 2;
FIG. 6 is a side elevational view taken from the right side of FIG. 2; and
FIG. 7 is a rear elevational view thereof.

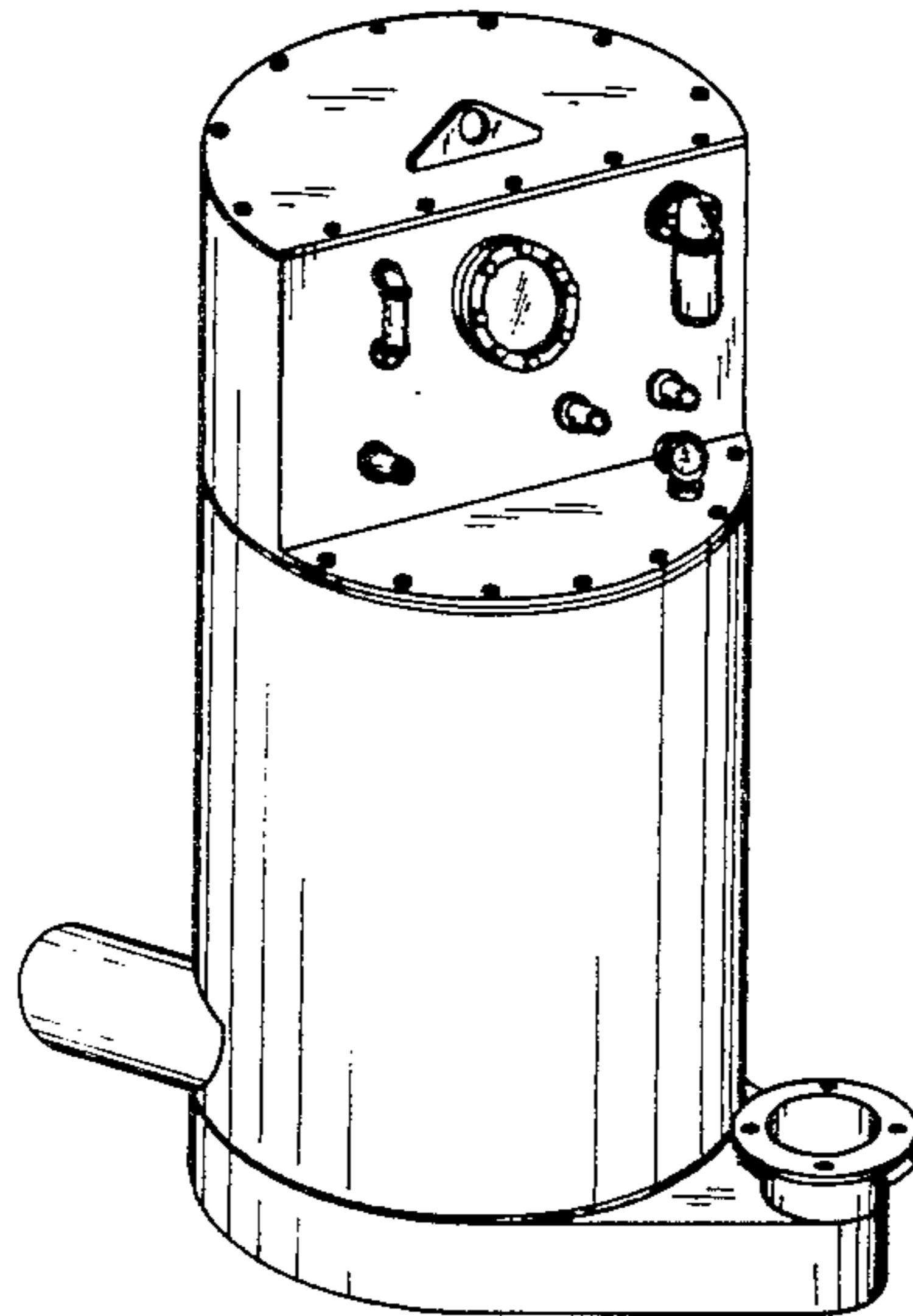

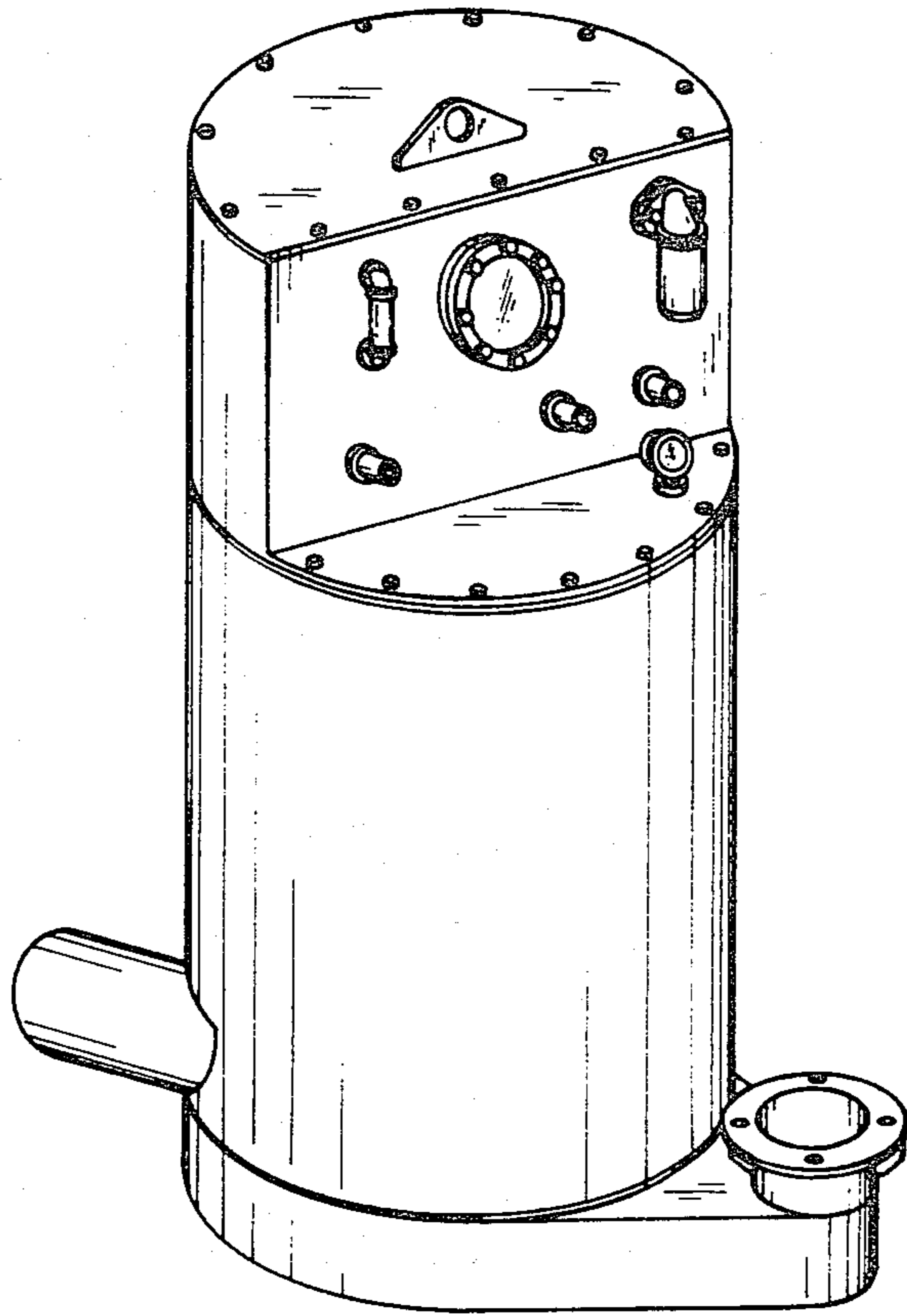

FIG. 1

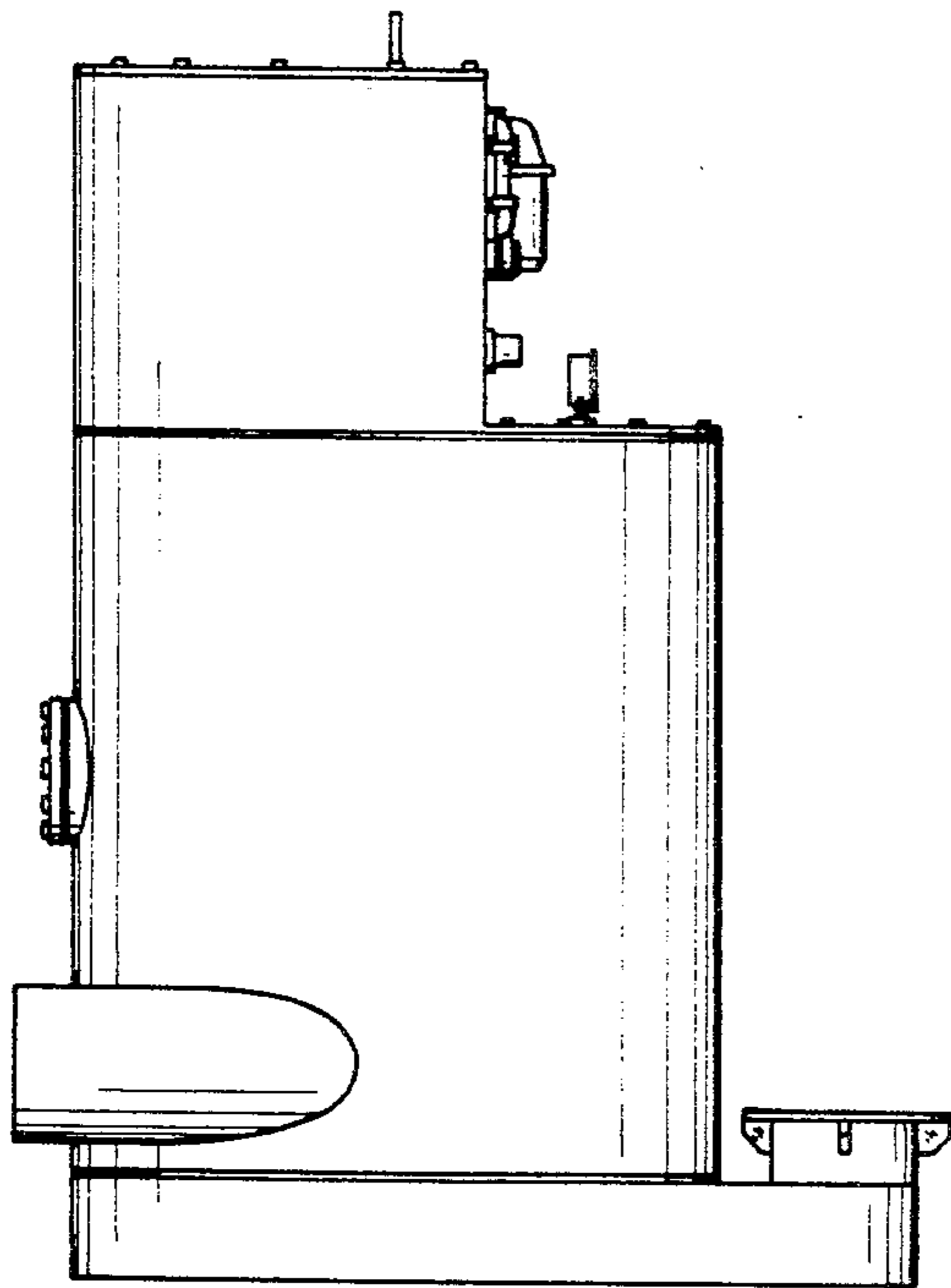

FIG. 5

FIG. 2

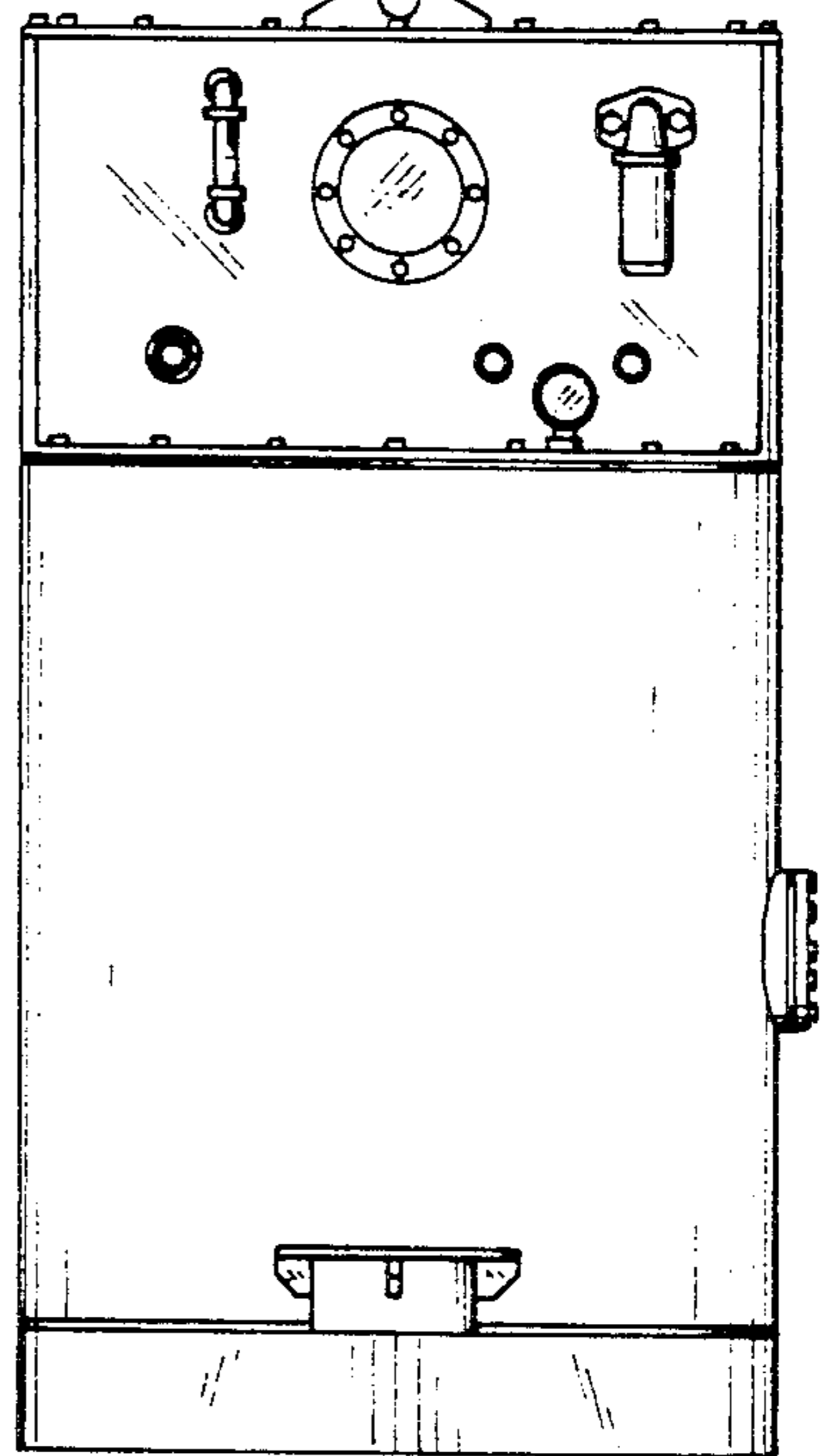

FIG. 3

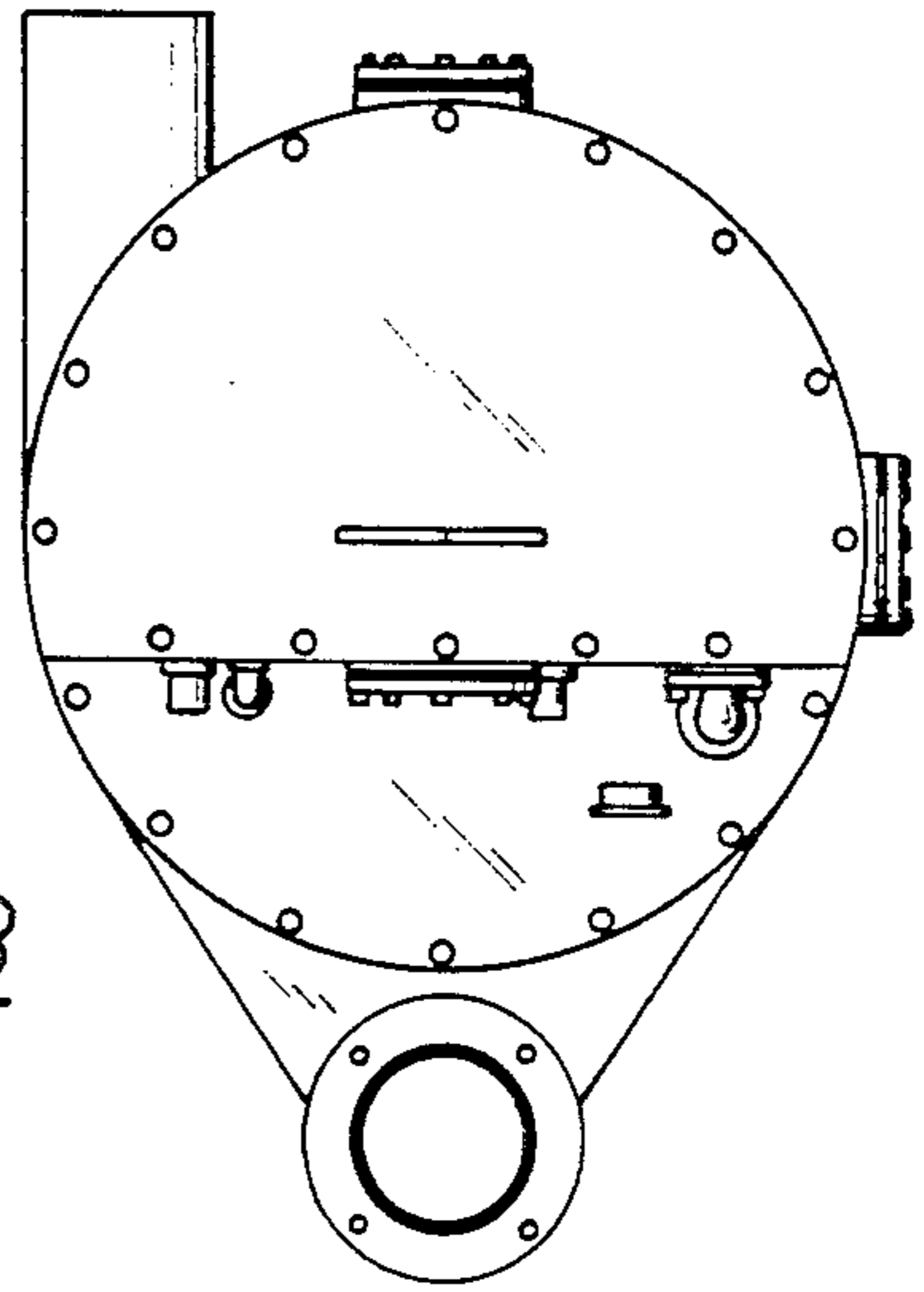
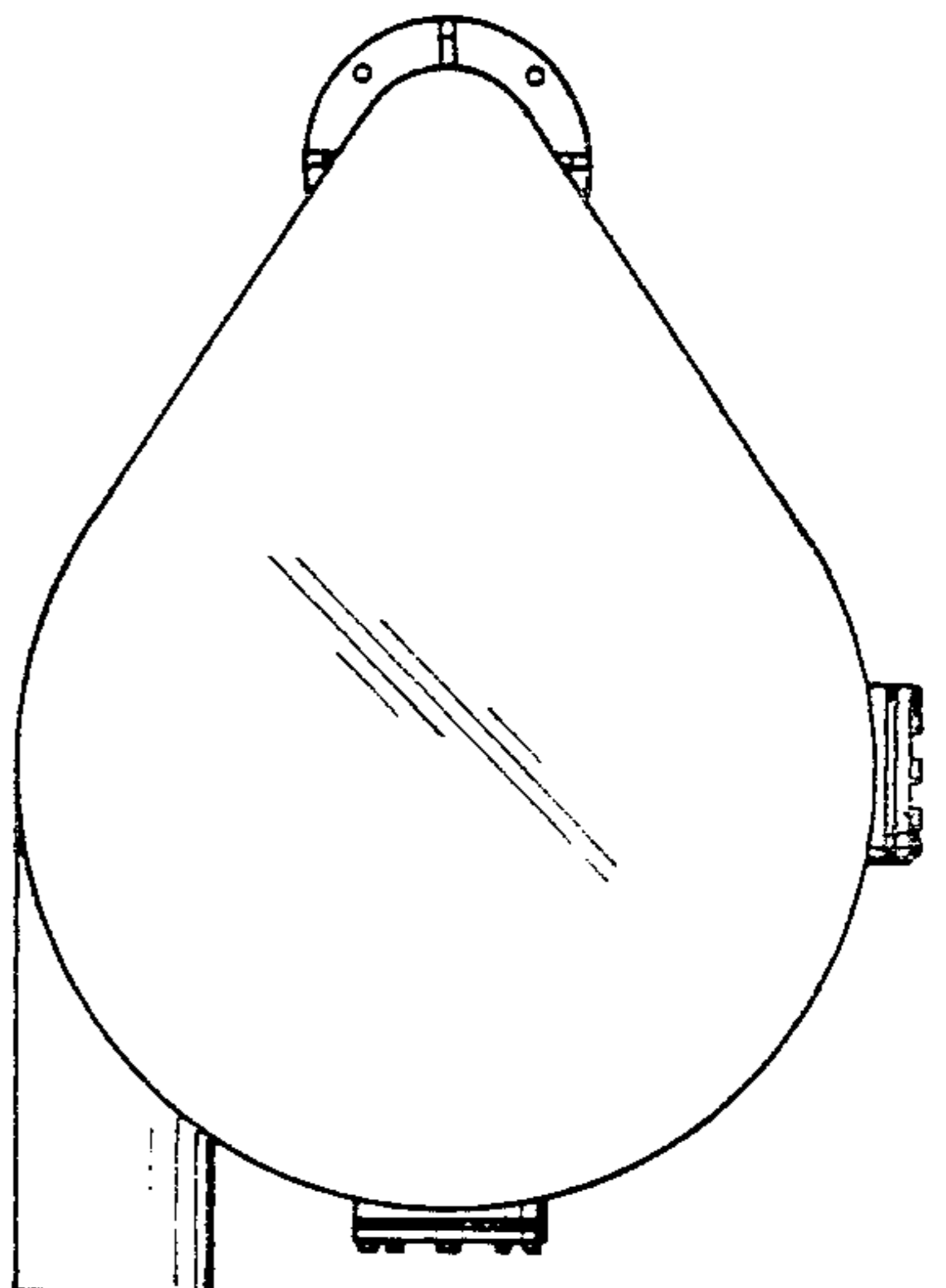

FIG. 4



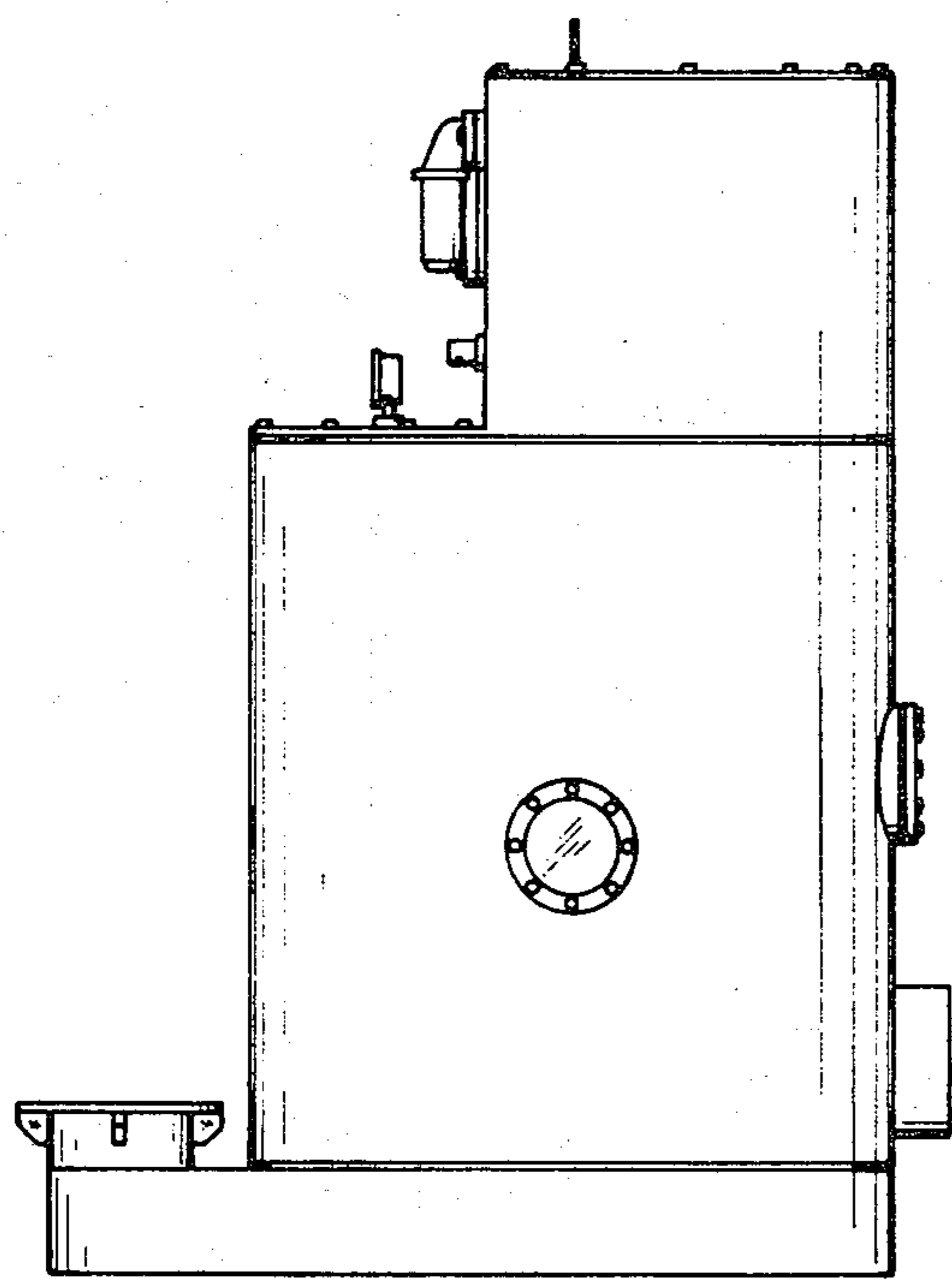

FIG. 6

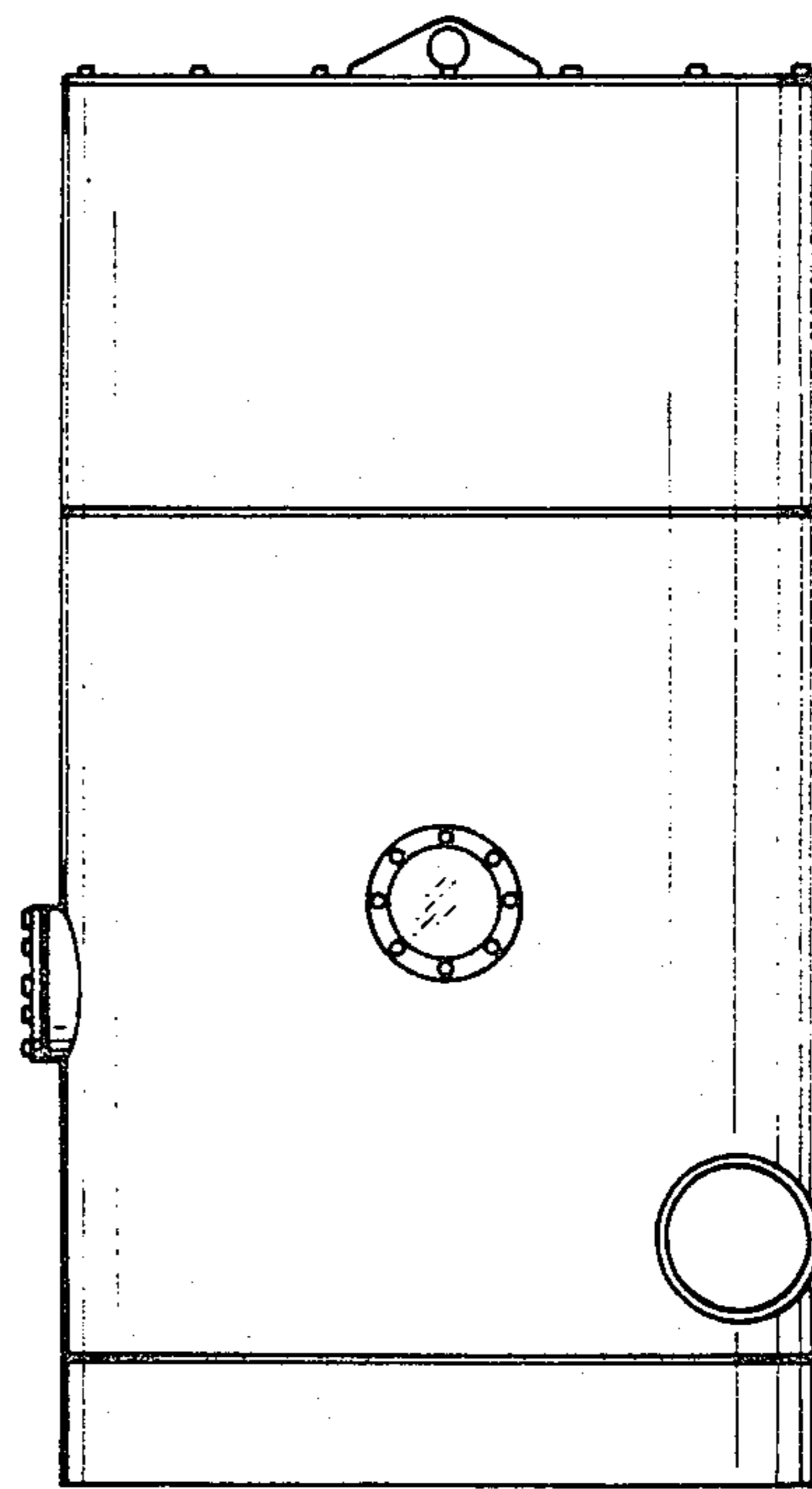

FIG. 7