

[54] **BUTTON**

[76] Inventor: Alfred C. De Rosa, 145 Dorwin Ave., Syracuse, N.Y. 13205

[\*\*] Term: 14 Years

[21] Appl. No.: 629,764

[22] Filed: Jul. 11, 1984

[52] U.S. Cl. .... D11/95; D11/41; D11/80

[58] Field of Search ..... D11/1, 2, 6, 7, 40, D11/41, 43-47, 48, 75, 79-81, 86, 95, 99; 40/1.5, 1.6; 362/104; 63/1 R-2, 18-21, 23

[56] **References Cited**

**U.S. PATENT DOCUMENTS**

D. 25,544	5/1896	Brown	.....	D11/108
919,983	4/1909	Walsh	.....	63/18
2,340,402	2/1944	Mitchel	.....	40/1.5
2,341,467	2/1944	Nedell	.....	40/1.5

Primary Examiner—Louis S. Zarfes  
Attorney, Agent, or Firm—Bruns and Wall

[57] **CLAIM**

The ornamental design for a button, as shown and described.

**DESCRIPTION**

FIG. 1 is a top perspective view of a button showing my new design;  
 FIG. 2 is a bottom perspective view thereof;  
 FIG. 3 is a top plan view thereof;  
 FIG. 4 is a bottom plan view thereof;  
 FIG. 5 is a right side elevation thereof;  
 FIG. 6 is a left side elevation thereof;  
 FIG. 7 is an upper side elevation thereof;  
 FIG. 8 is a lower side elevation thereof;  
 FIG. 9 is a sectional view taken along line 9—9 in FIG. 4;  
 FIG. 10 is a sectional view taken along line 10—10 in FIG. 4.  
 FIG. 11 is a sectional view taken along line 11—11 in FIG. 4;  
 FIG. 12 is an exploded view in perspective thereof showing the two sections of the button separated; and  
 FIG. 13 is also an exploded view in perspective showing the two sections of the button separated and the clip removed.

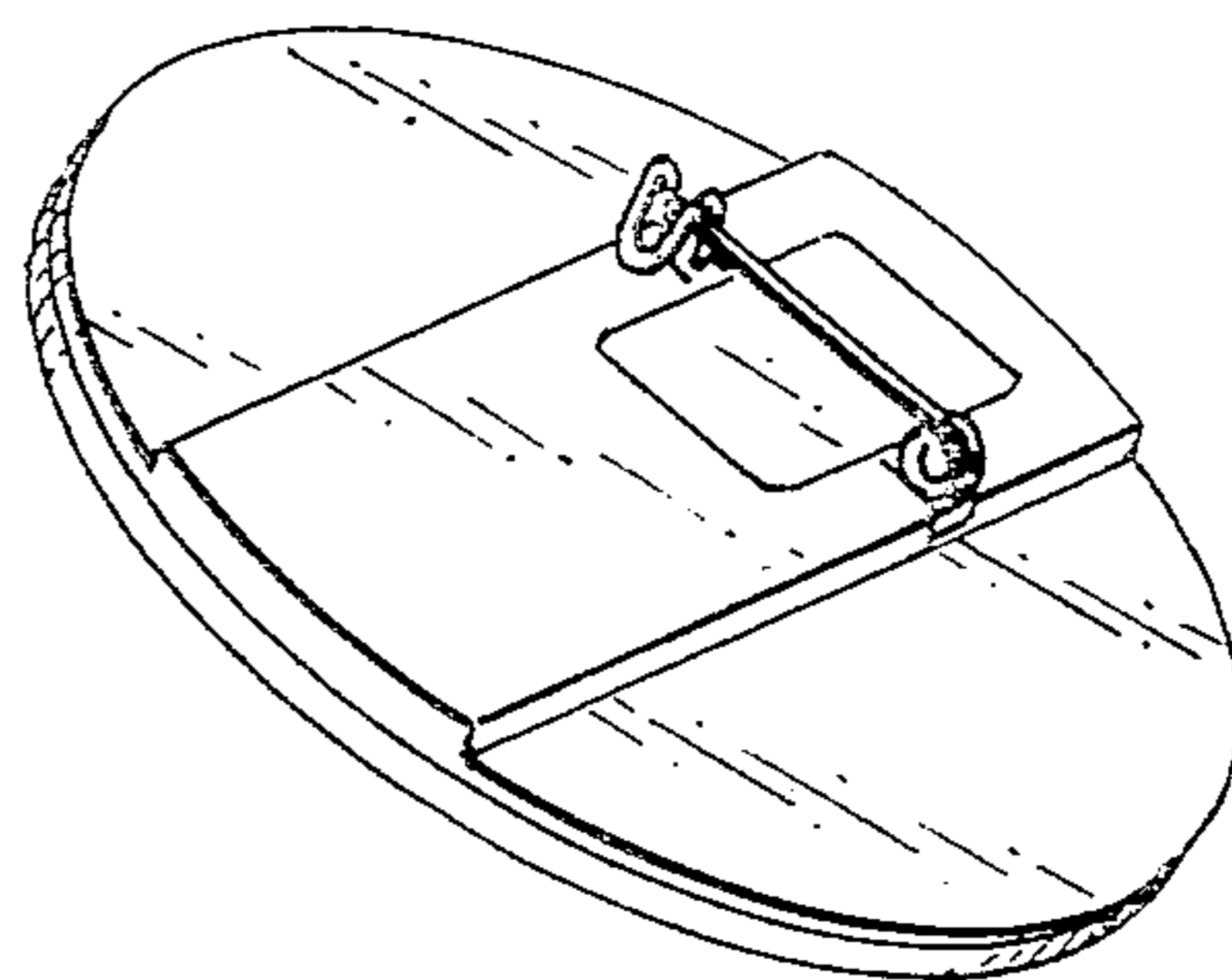
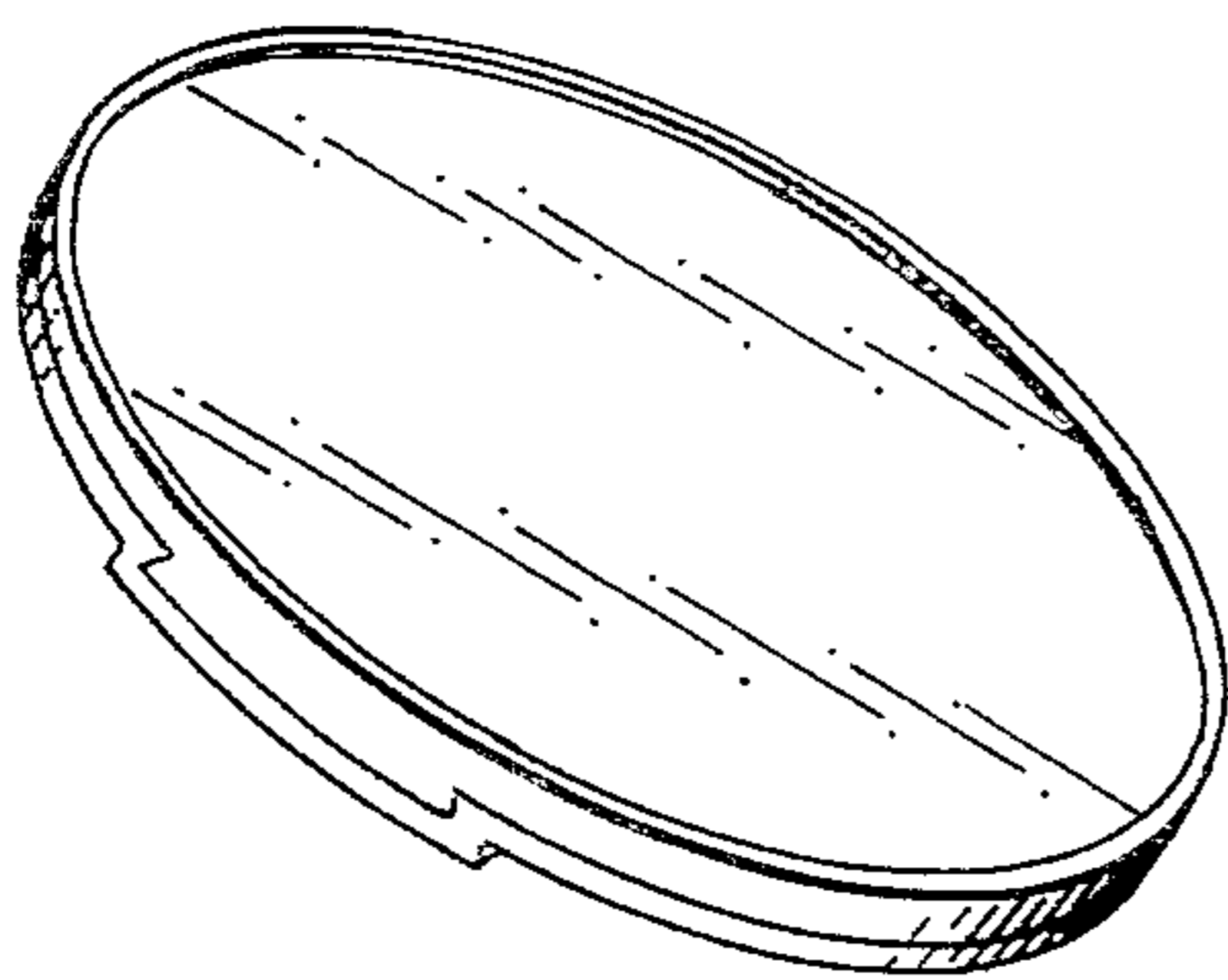

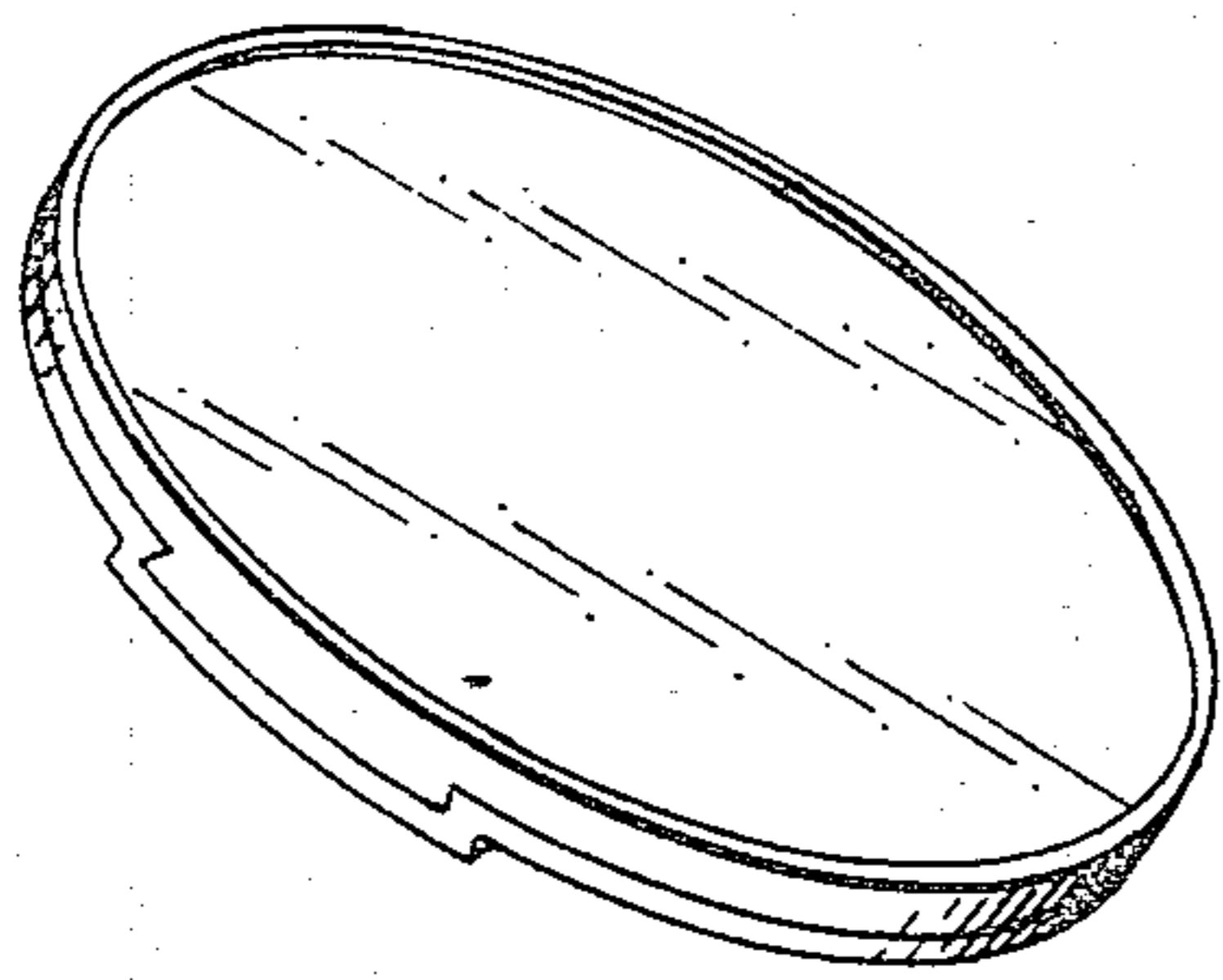

FIG. 1

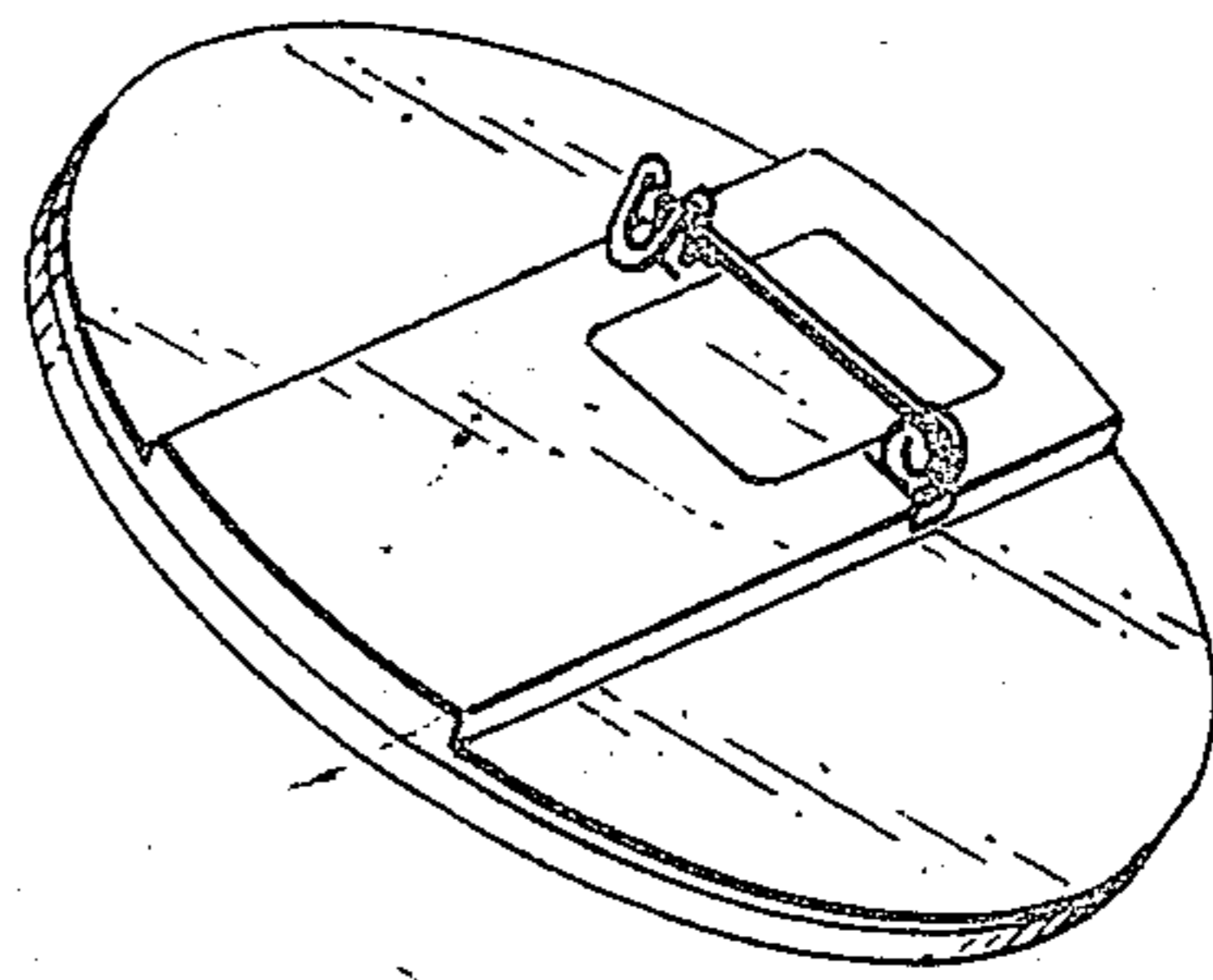

FIG. 2

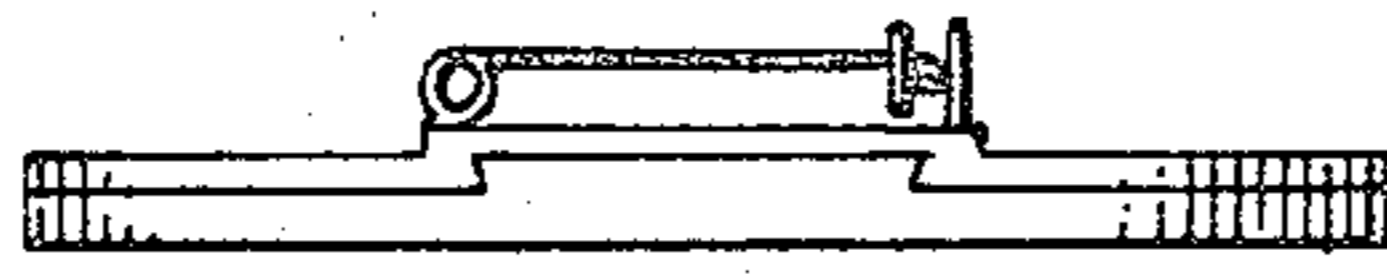

FIG. 7

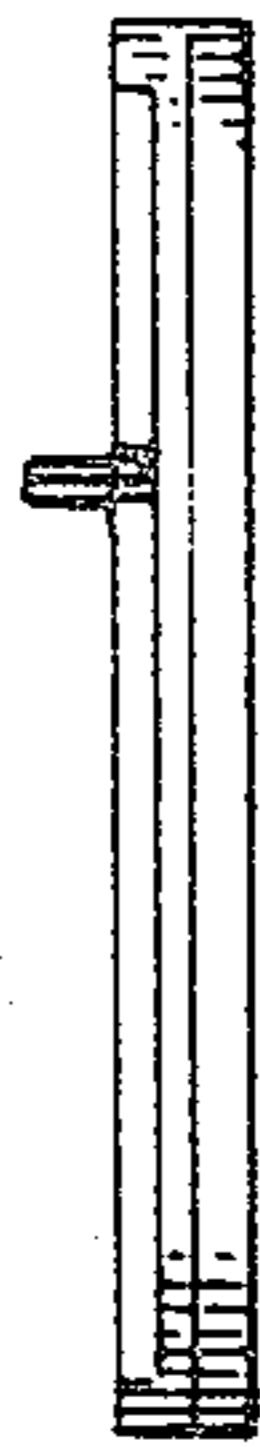

FIG. 6

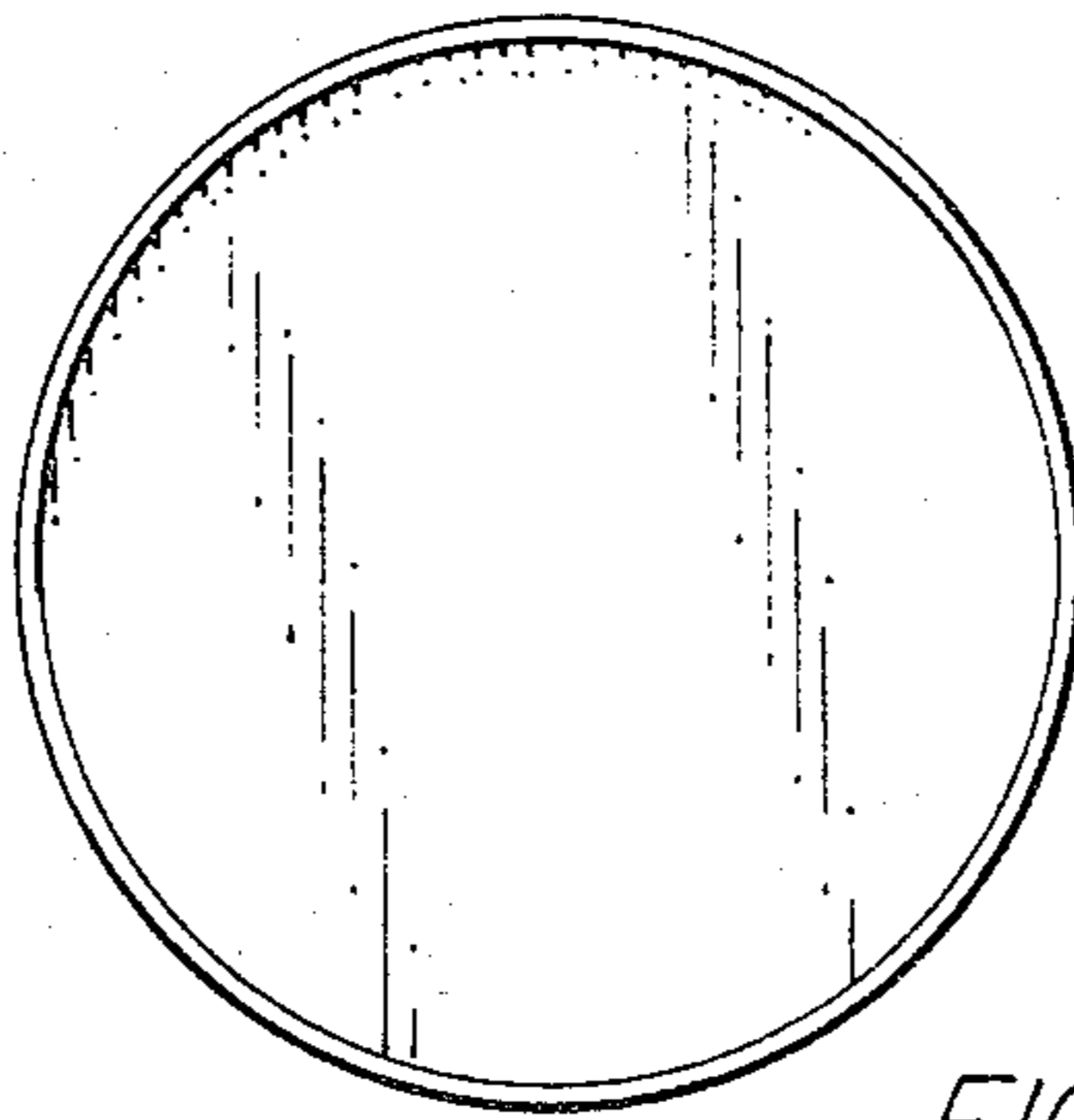

FIG. 3

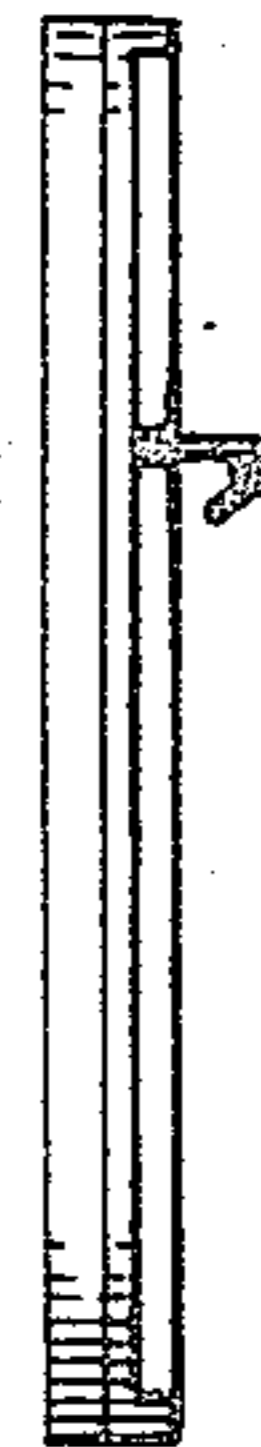

FIG. 5

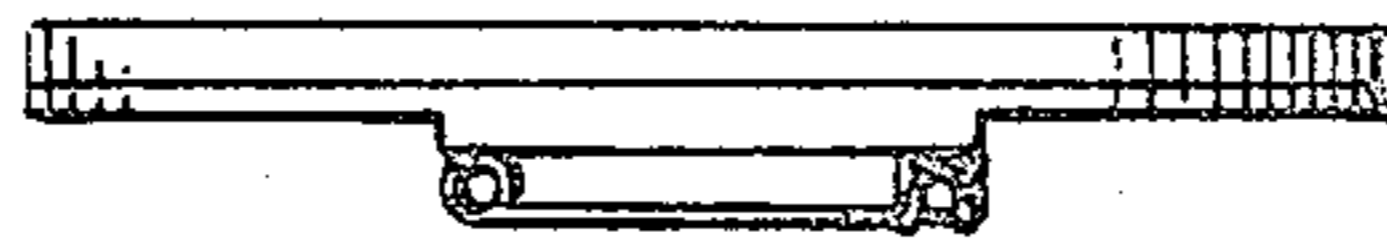

FIG. 8

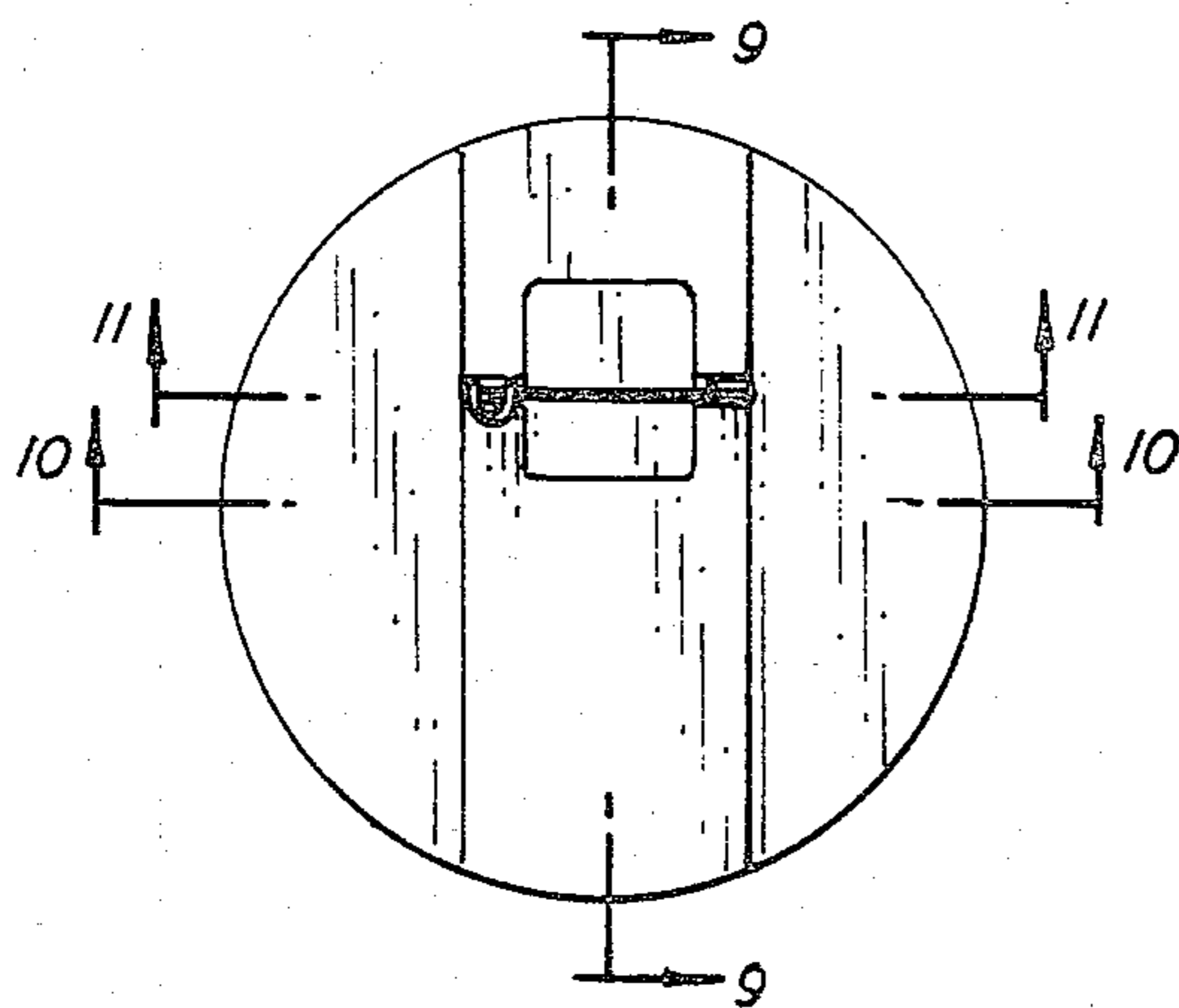

FIG. 4

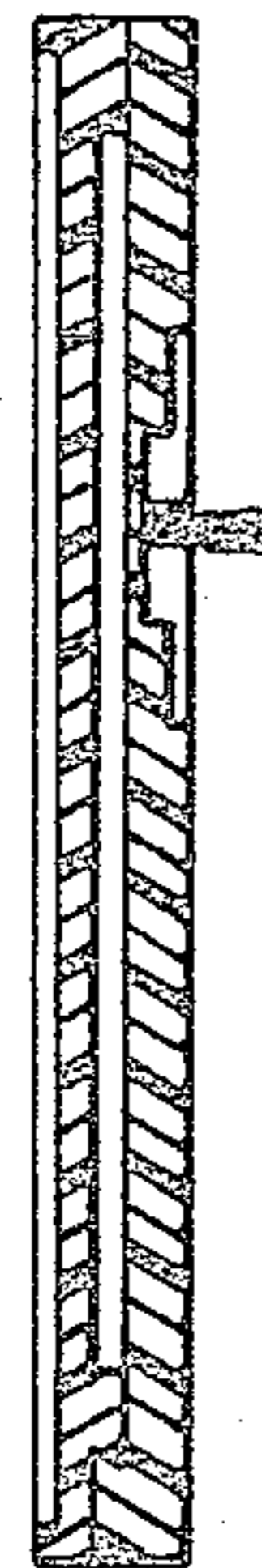

FIG. 9

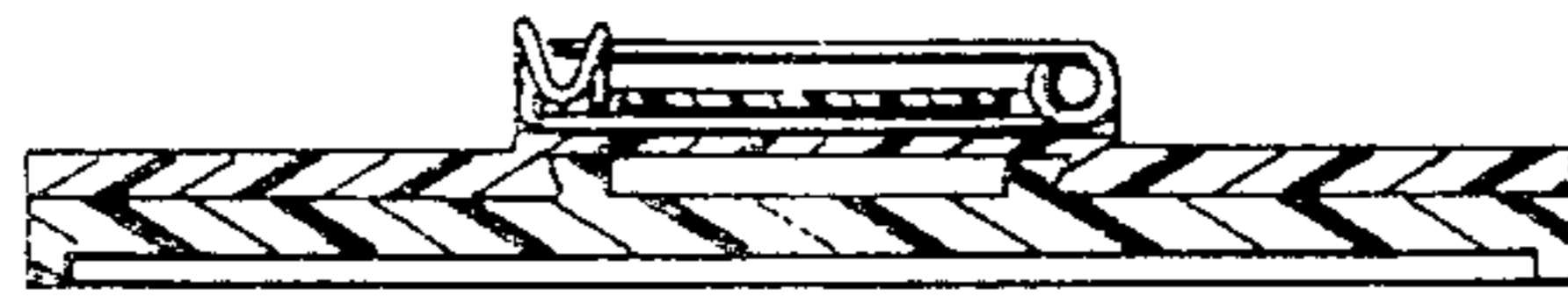

FIG. 11

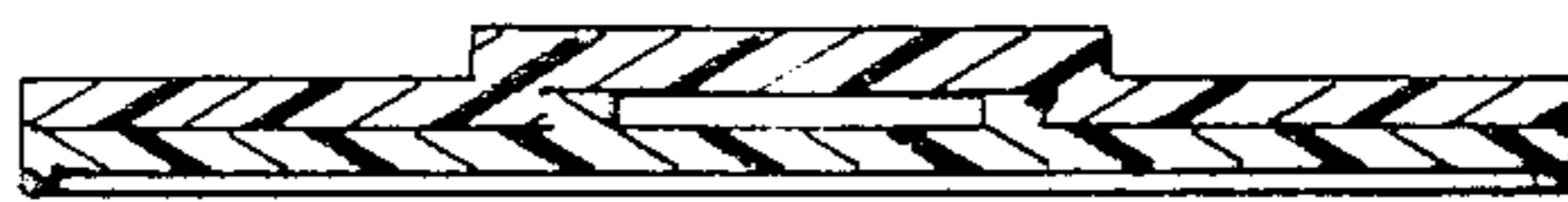

FIG. 10

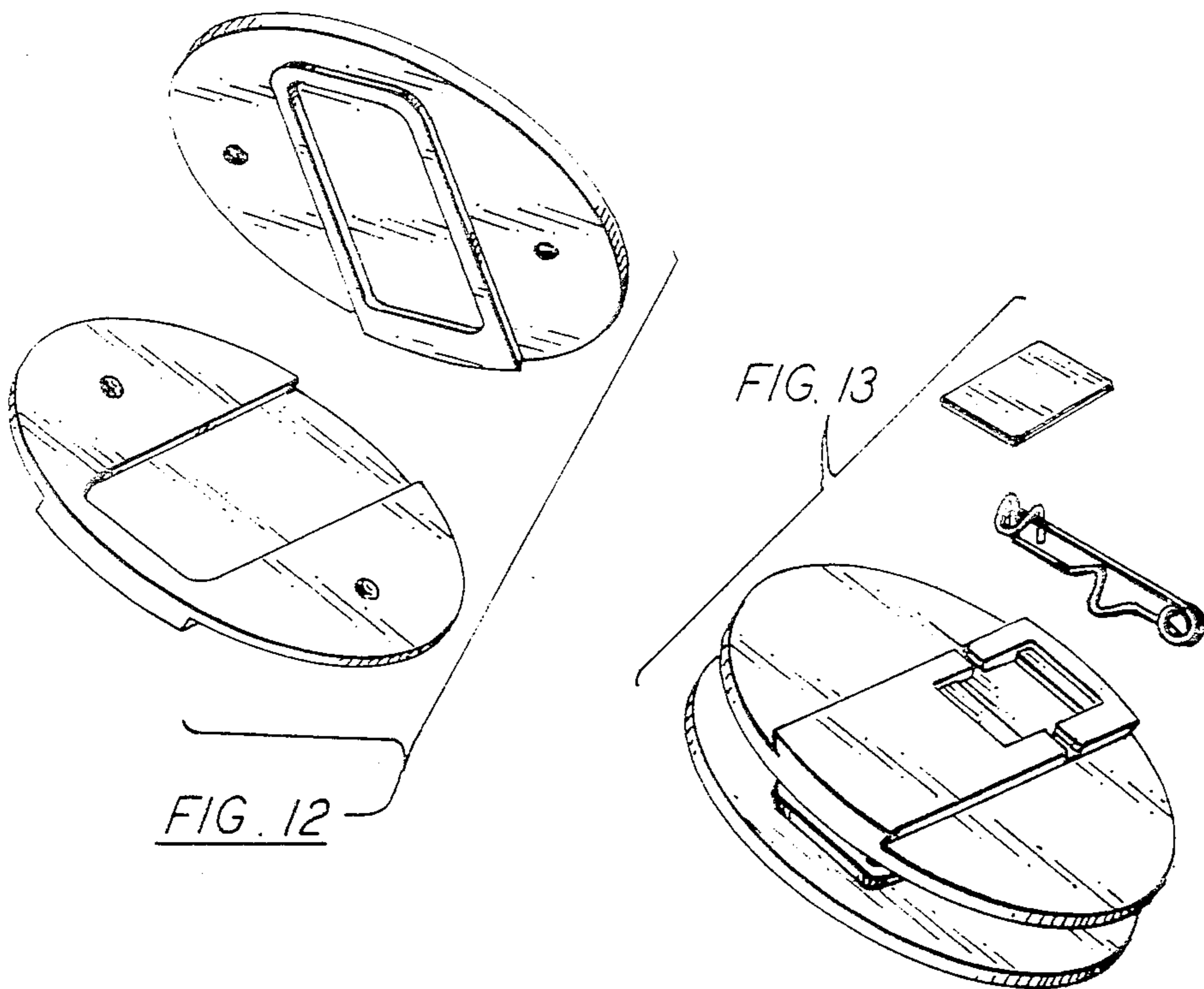

FIG. 12

FIG. 13