

[54] ELECTRIC LAMP

[76] Inventor: Kimiko Ikeda, 6-15, Sendagaya 5-chome, Shibuya-ku, Tokyo, Japan

[**] Term: 14 Years

[21] Appl. No.: 520,859

[22] Filed: Aug. 5, 1983

[30] Foreign Application Priority Data

Feb. 8, 1983 [JP] Japan 58-4760
[52] U.S. Cl. D26/93; D11/131; D26/72
[58] Field of Search D26/93-112, D26/24, 67, 68, 72, 85, 87, 88, 91, 92; 362/410-414, 431, 806; D11/131

[56] References Cited

U.S. PATENT DOCUMENTS

D. 178,075 6/1956 Manley D26/104
D. 223,282 4/1972 Andre D26/72 X
D. 236,646 9/1975 Stewart D26/85
3,793,515 2/1974 Park D26/104 X

OTHER PUBLICATIONS

Architectural Record, Mid-May, 1970, p. 21, Lamp (top).
Industrial Design, 6-1963, p. 35, Lamp #6.
Progress Lighting Catalog, 1972, p. 57, Wall Lamp, P-3120-3130.

Primary Examiner—Susan J. Lucas
Attorney, Agent, or Firm—Robert E. Burns; Emmanuel J. Lobato; Bruce L. Adams

[57] CLAIM

The ornamental design for an electric lamp, substantially as shown and described.

DESCRIPTION

FIG. 1 is a front elevational view of an electric lamp showing my new design;
FIG. 2 is a top plan view thereof;
FIG. 3 is a bottom plan view thereof;
FIG. 4 is a rear elevational view thereof;
FIG. 5 is a right side elevational view thereof, the left side being a mirror image thereto;
FIG. 6 is a top left perspective view thereof;
FIG. 7 is a cross-sectional view thereof taken generally along the line 7-7 of FIG. 1 with the inner contents thereof omitted for clarity; and
FIG. 8 is a cross-sectional view thereof taken generally along the line 8-8 of FIG. 1 with the inner contents thereof omitted for clarity.

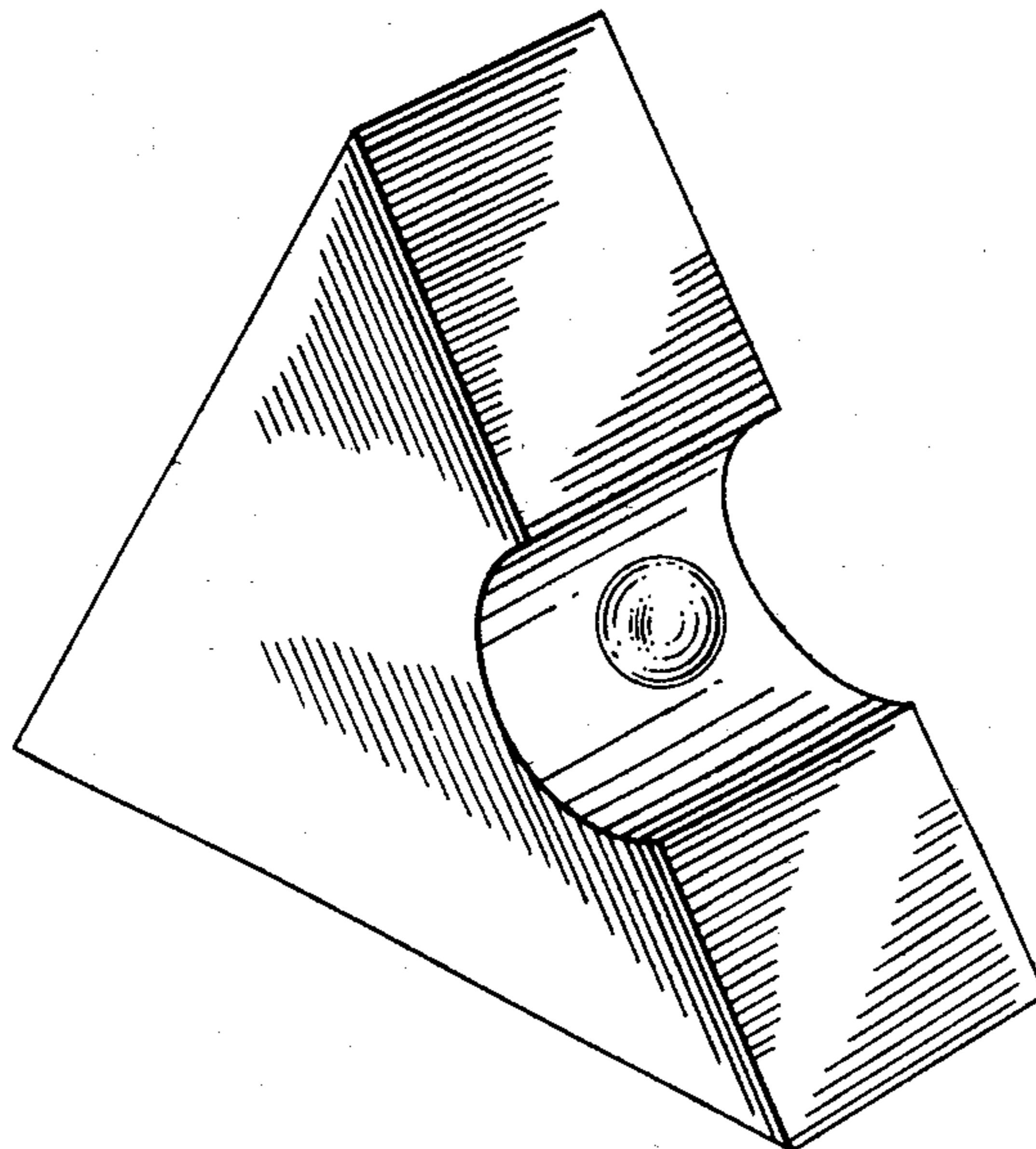

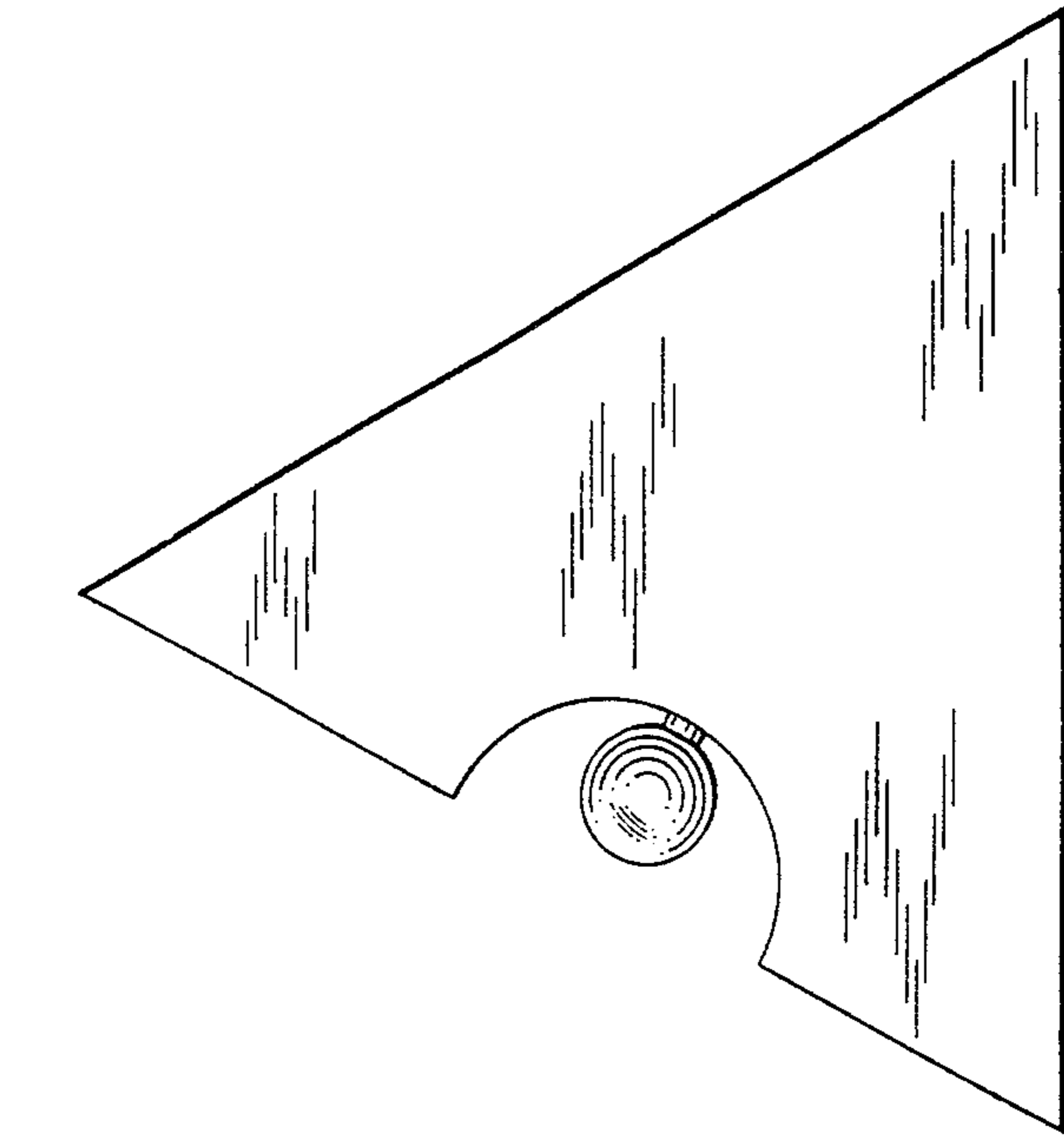

FIG. 5

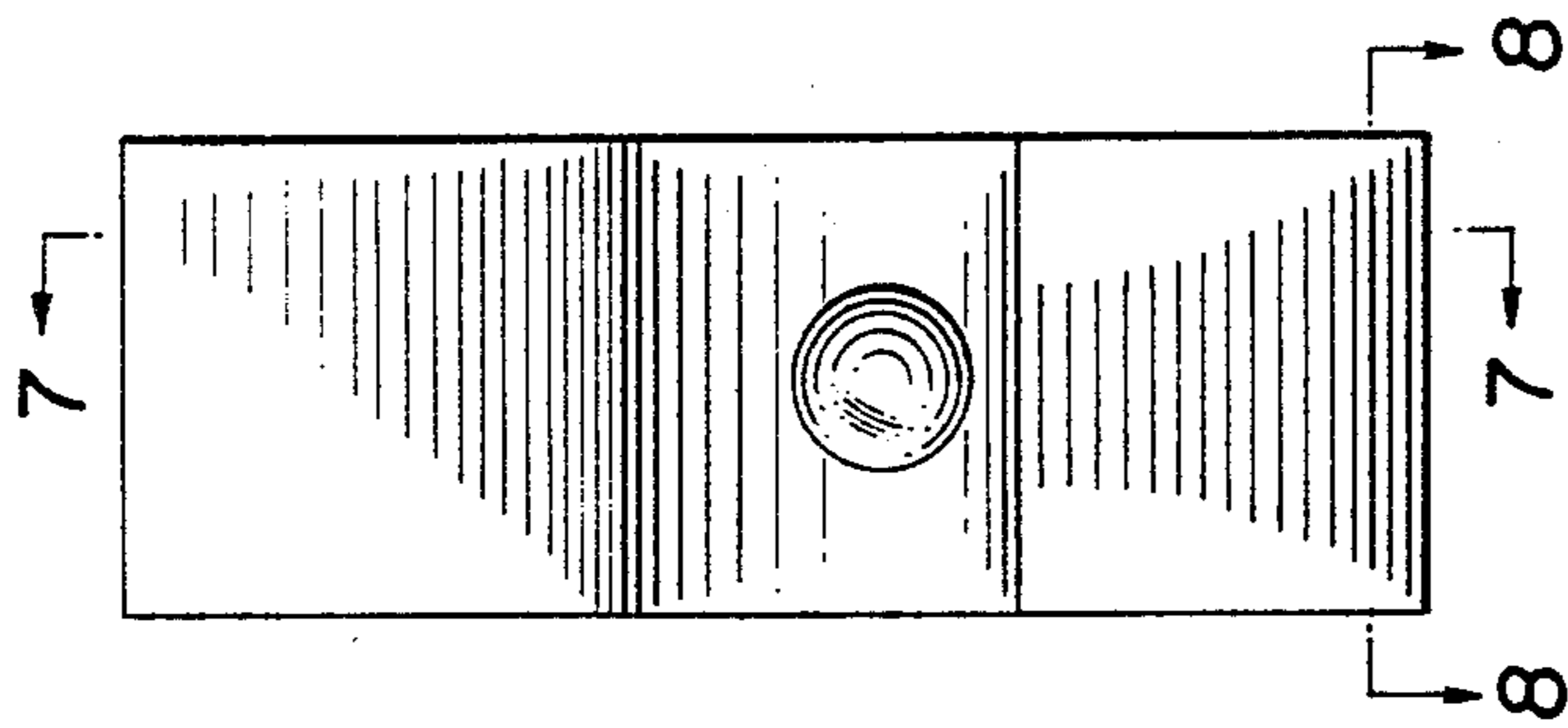

FIG. 1

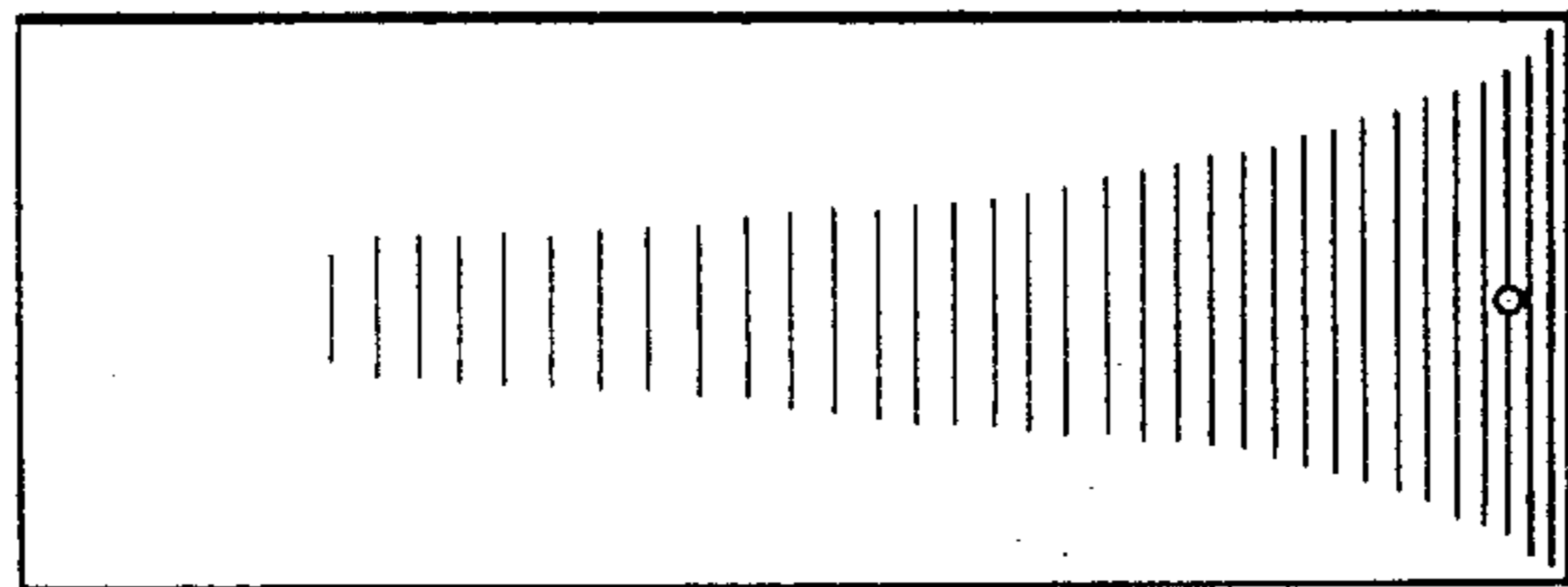

FIG. 4

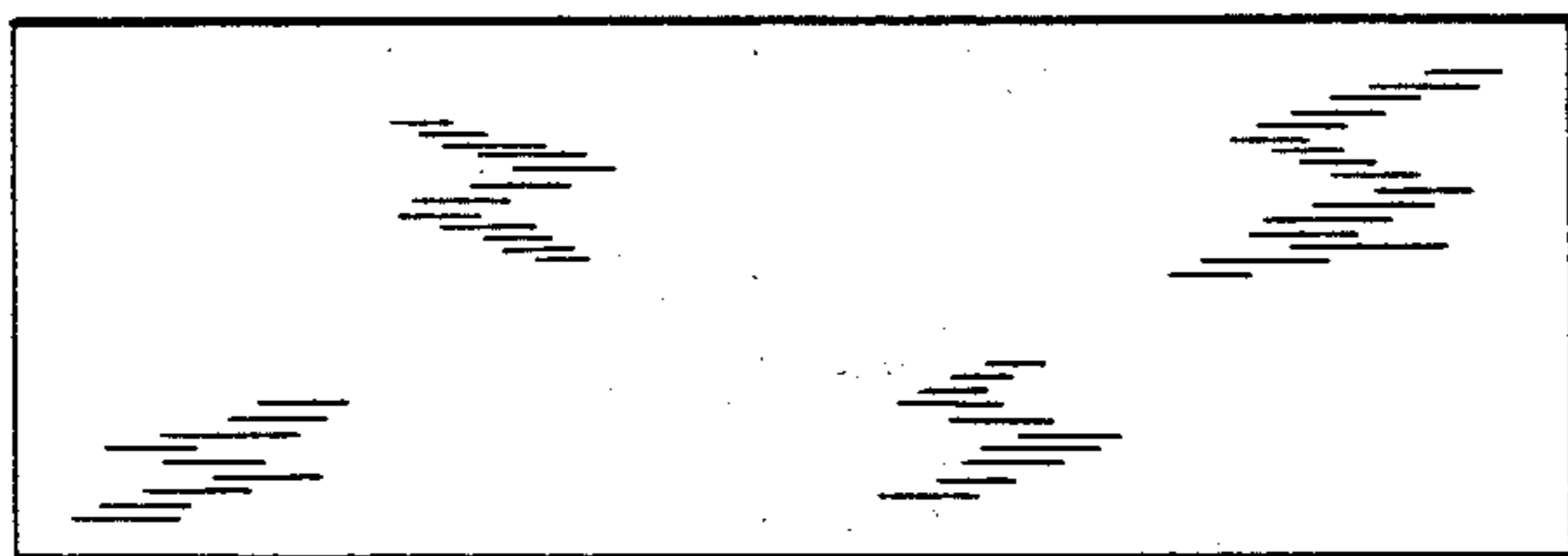

FIG. 3

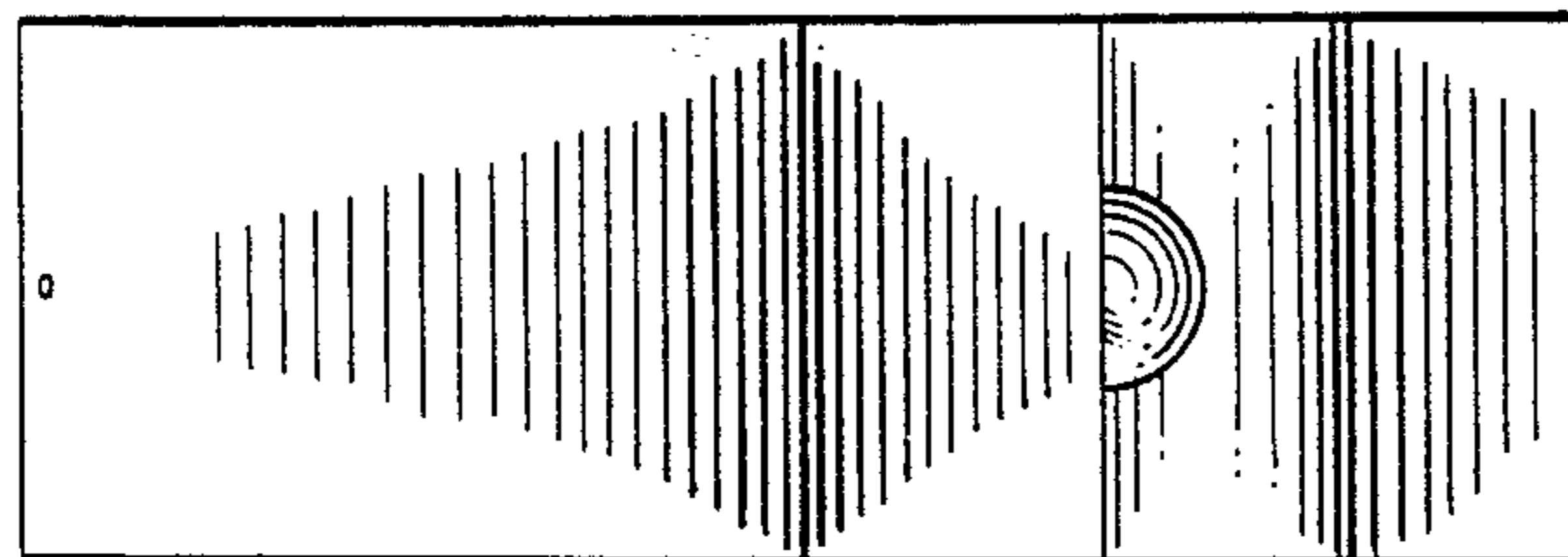

FIG. 2

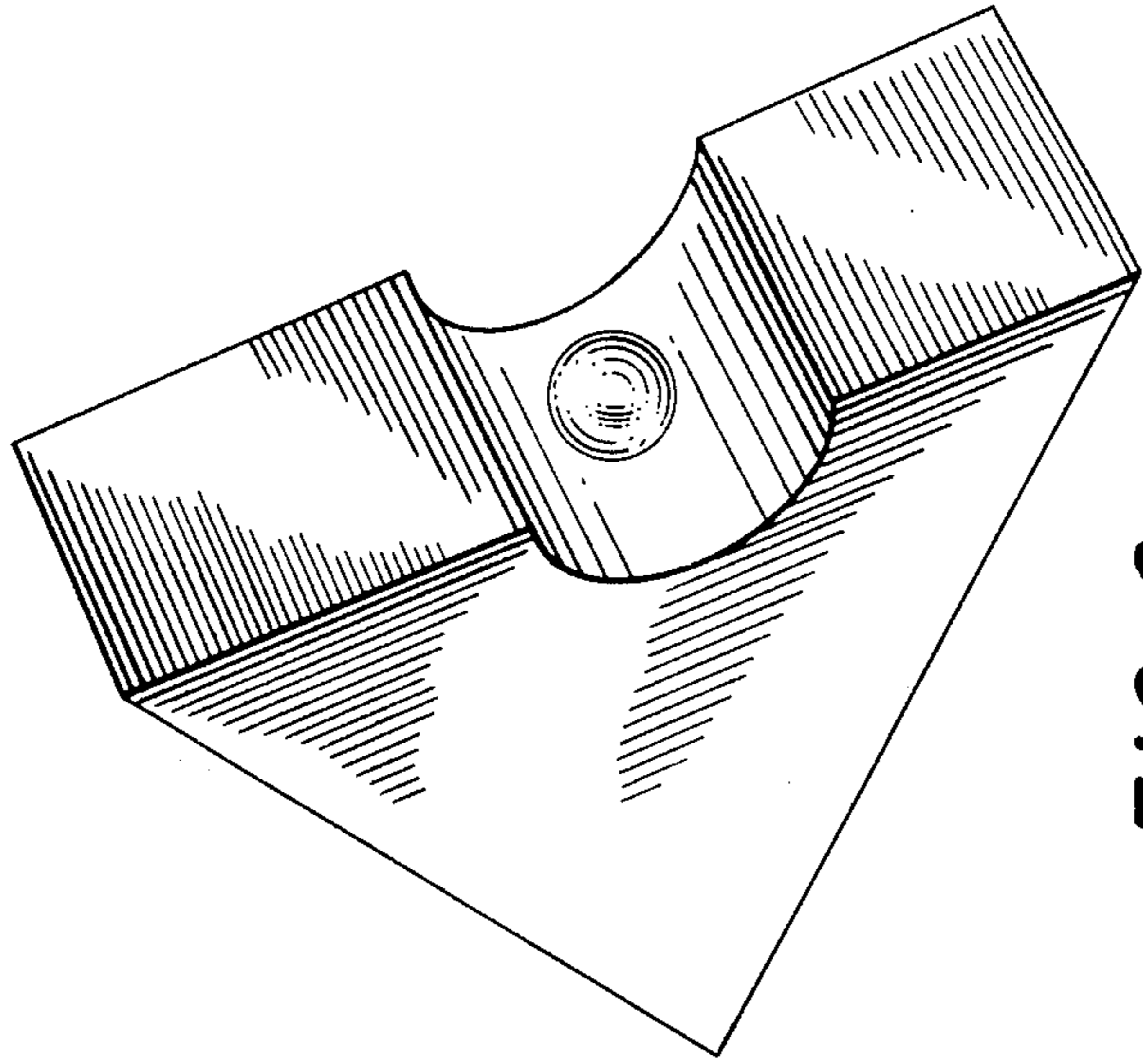

FIG. 6

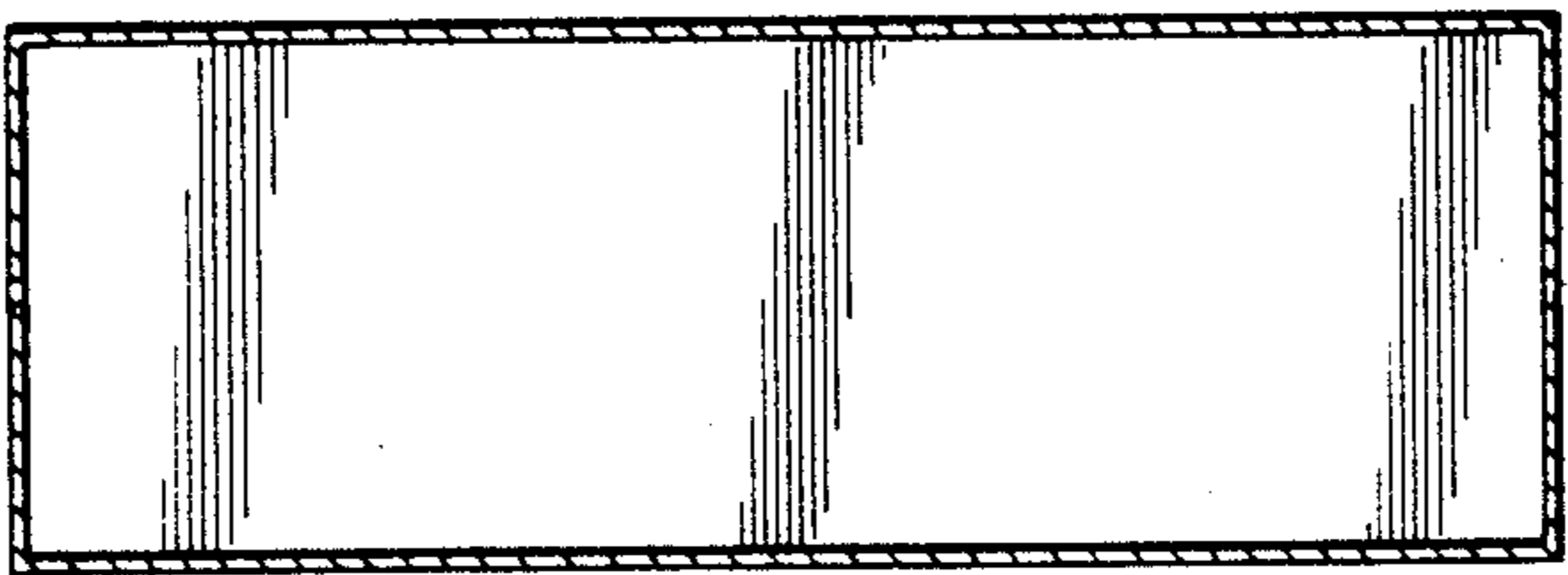

FIG. 8

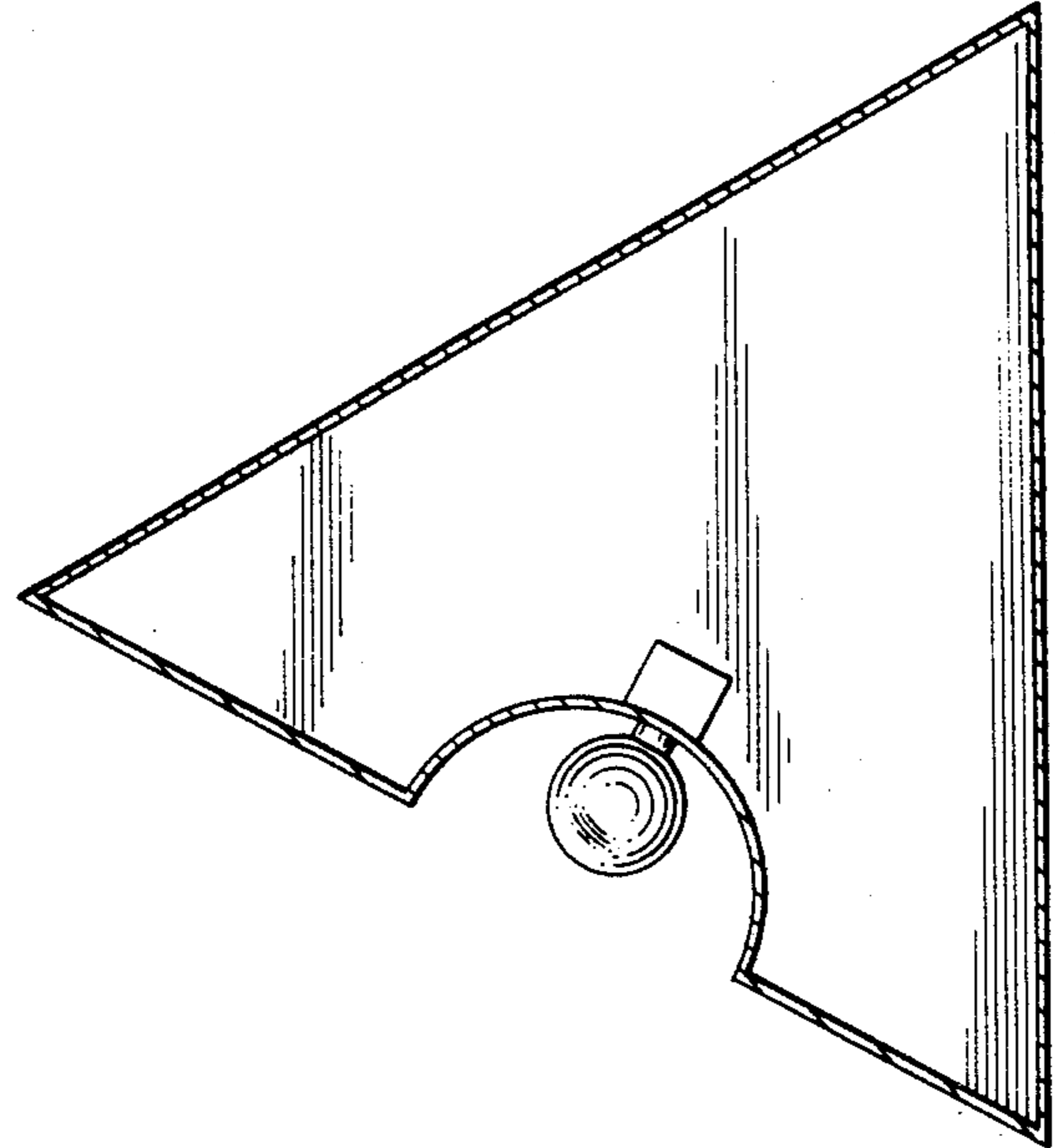

FIG. 7