

[54] LABEL HOLDER FOR USE ON A POSTAL SORTING BOX

[76] Inventor: Clarence Kopp, 293 Fillmore St., Centerport, N.Y. 11721

[\*\*] Term: 14 Years

[21] Appl. No.: 524,418

[22] Filed: Aug. 18, 1983

[52] U.S. Cl. .... D6/491

[58] Field of Search ..... D6/477, 478, 479, 491

[56] References Cited

U.S. PATENT DOCUMENTS

D. 200,813 4/1965 Cripe ..... D6/479 X

OTHER PUBLICATIONS

Montgomery Ward Catalog, "Valves For Summer 1979", ©1979, p. 268, Cabinet No. 1.

Global Equipment Co. Catalog, ©1974, p. 14, Storage Bin No. 252022.

Aurora Equipment Co., Cat., 1937, Automotive Bin Section, p. 2, Unit No. 403-1, Parts Bin.

Primary Examiner—Bruce W. Dunkins  
Attorney, Agent, or Firm—Bauer & Amer

[57] CLAIM

The ornamental design for a label holder for use on a postal sorting box, as shown and described.

DESCRIPTION

FIG. 1 is a perspective view of a label holder for use on a postal sorting box, showing my design; FIG. 2 is a front elevational view thereof; FIG. 3 is a plan view; FIG. 4 is a right side elevational view relative to FIG. 2; FIG. 5 is a left side elevational view relative to FIG. 2; FIG. 6 is a bottom view; and FIG. 7 is a rear elevational view thereof. The broken lines shown in FIGS. 1, 2, 3, 4 and 6 are for illustrative purposes only.

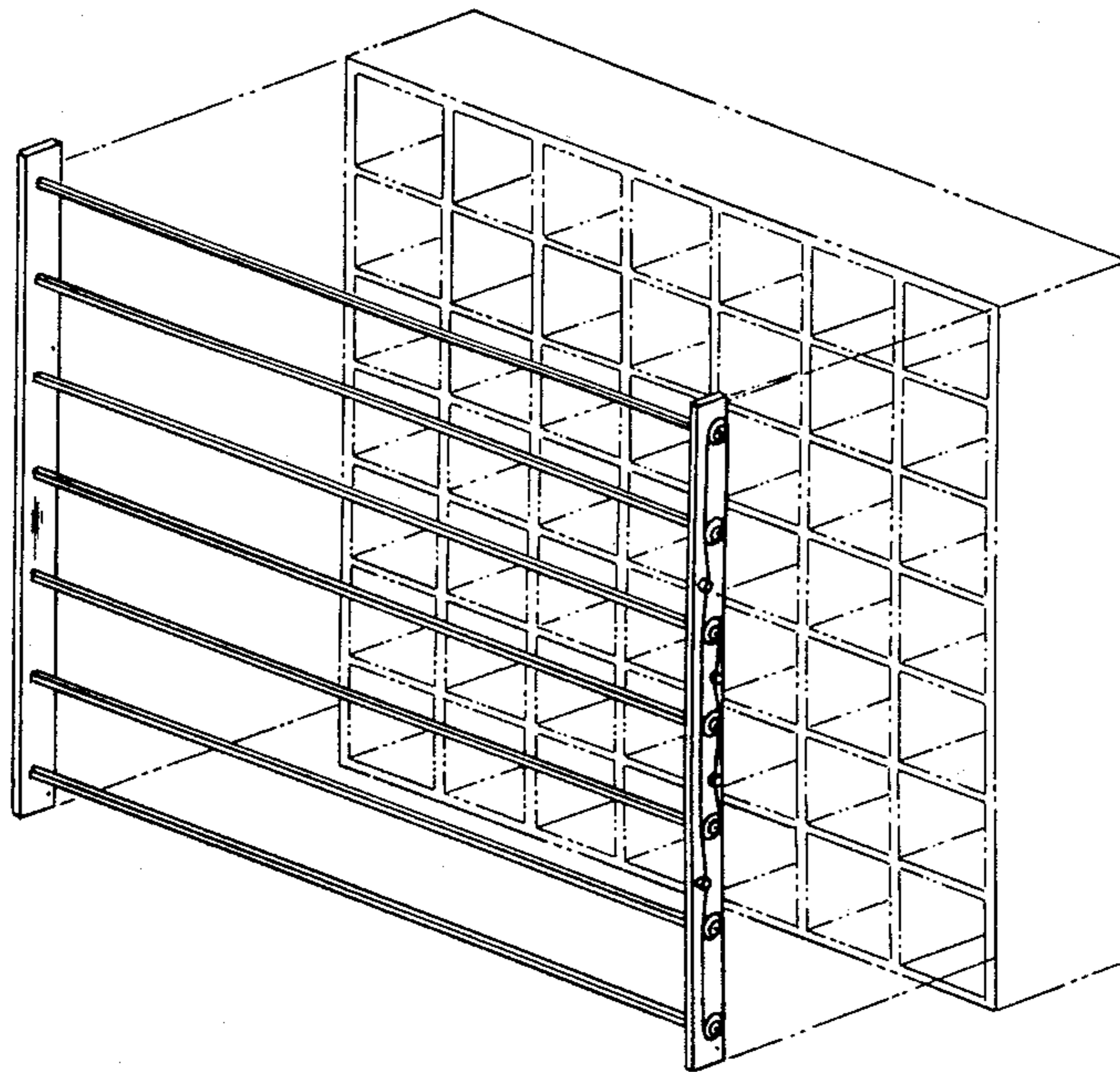

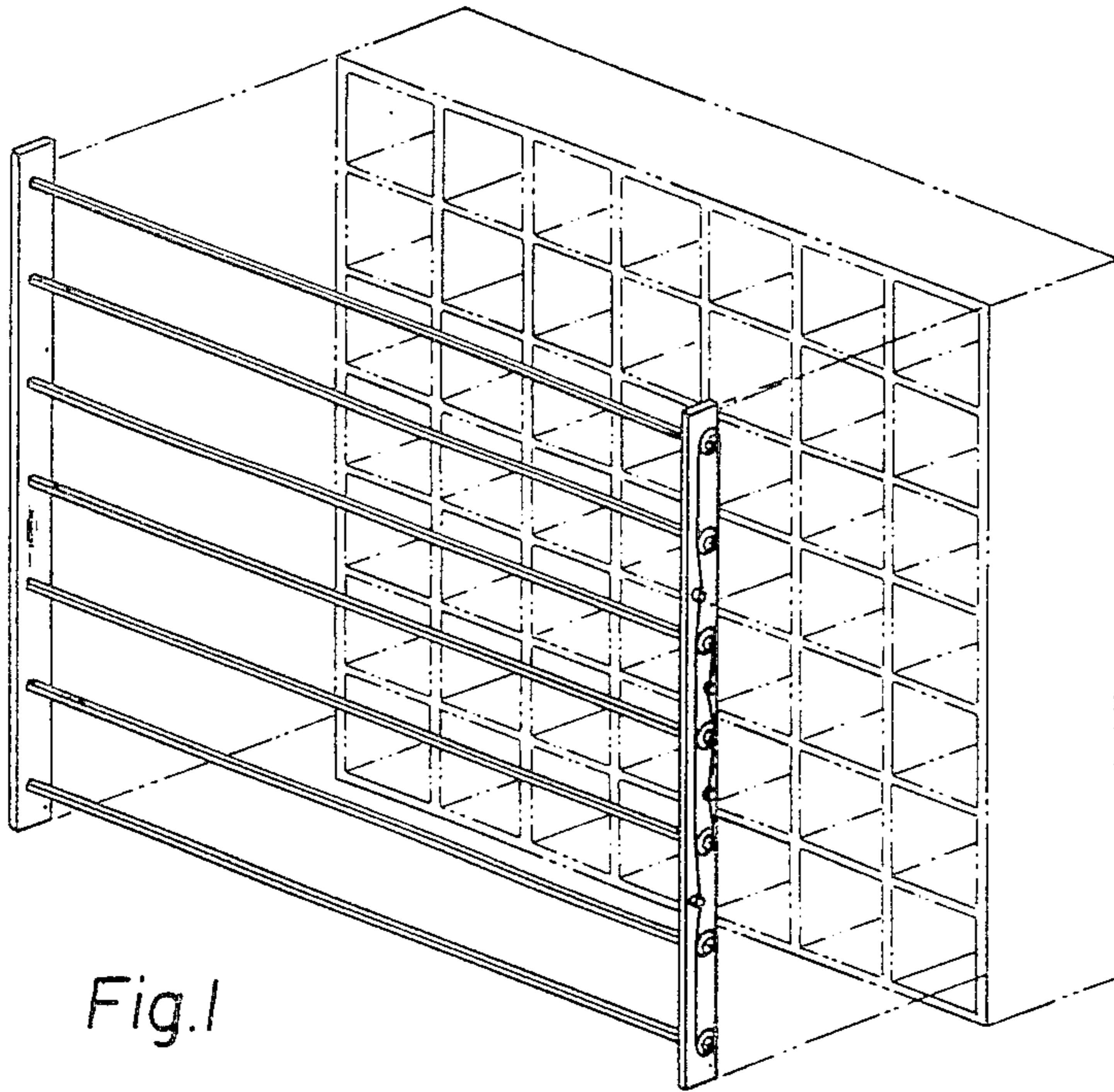

Fig. 1

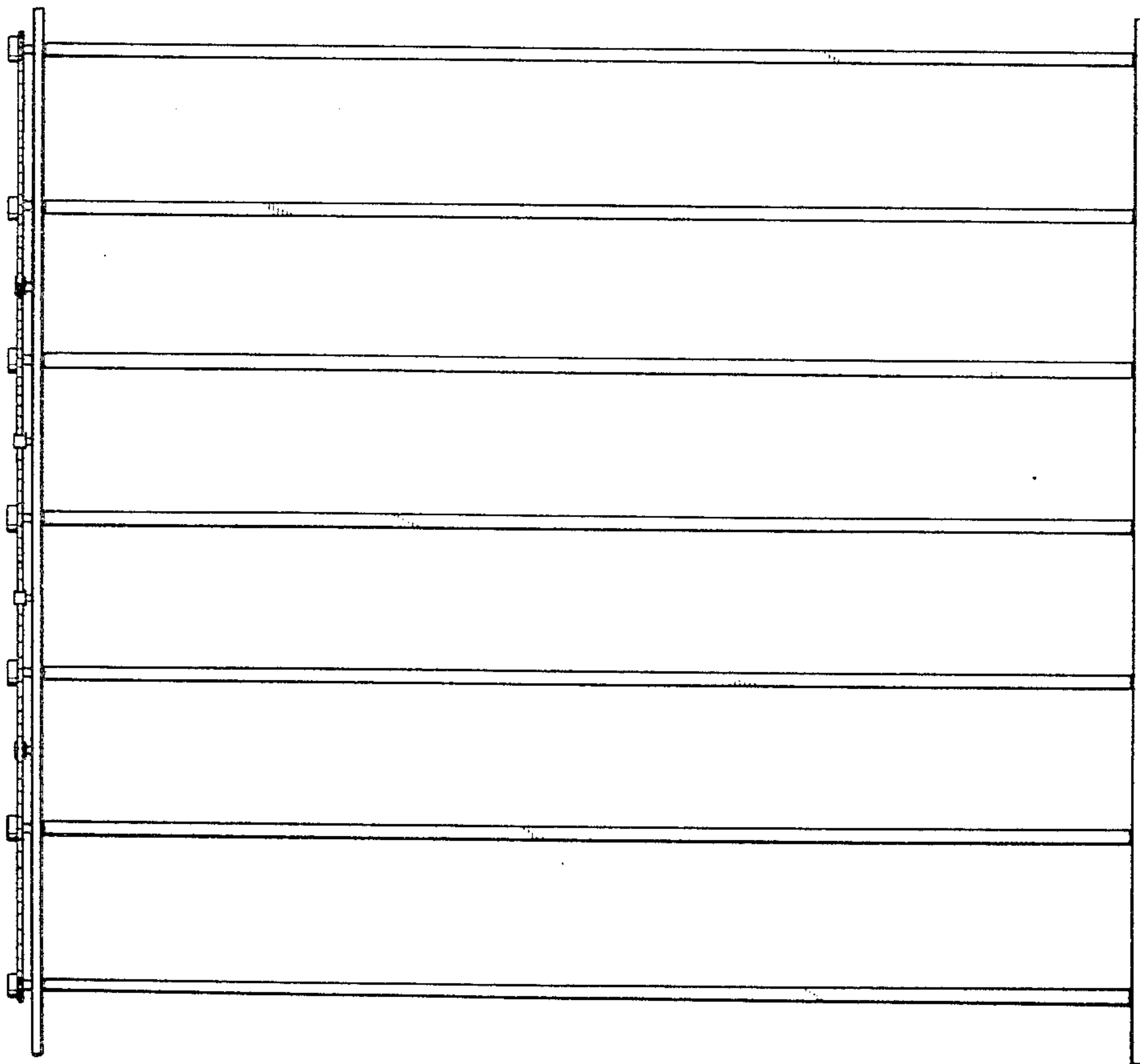

Fig. 7

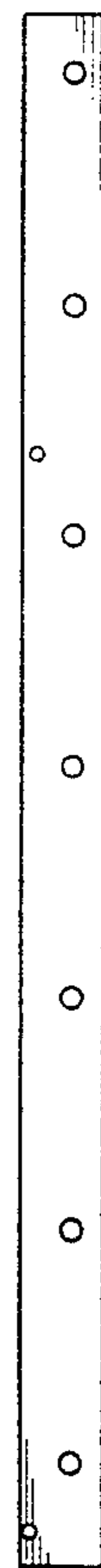

Fig. 5

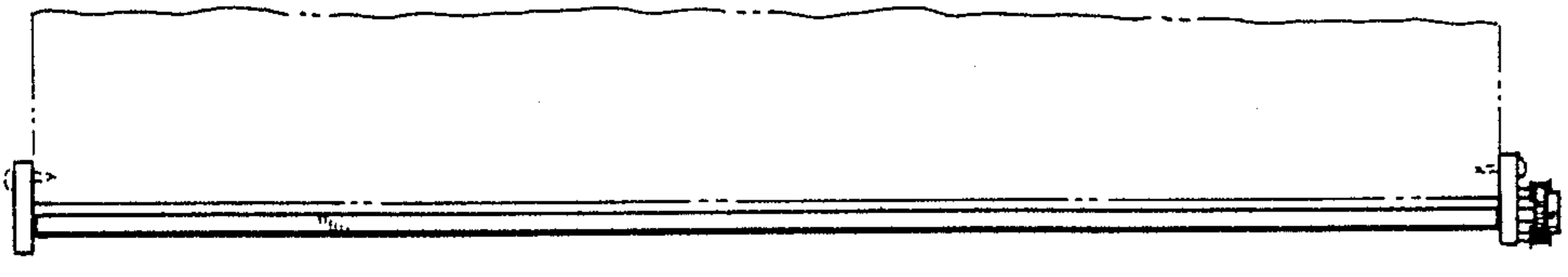

Fig. 3

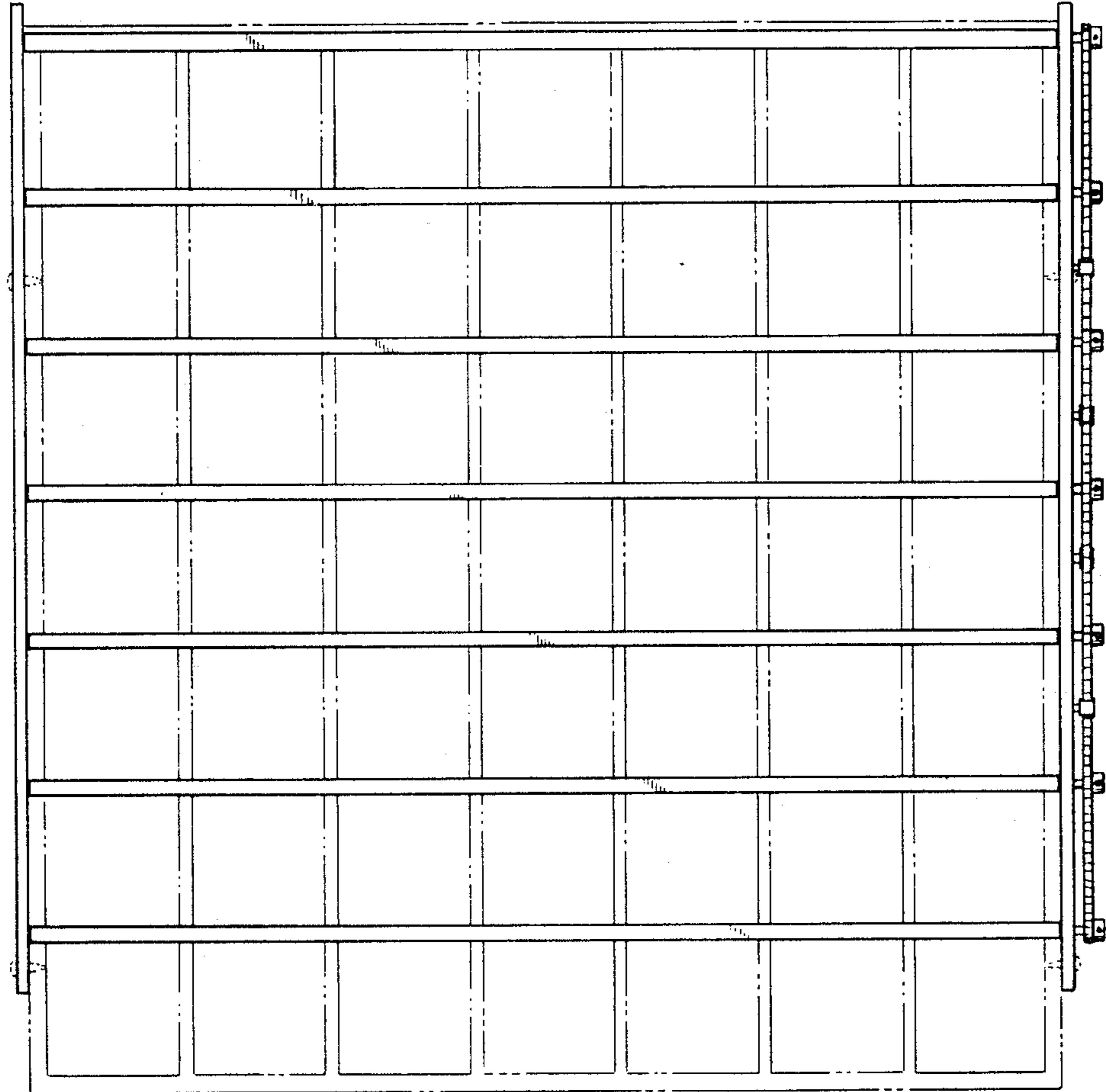

Fig. 2

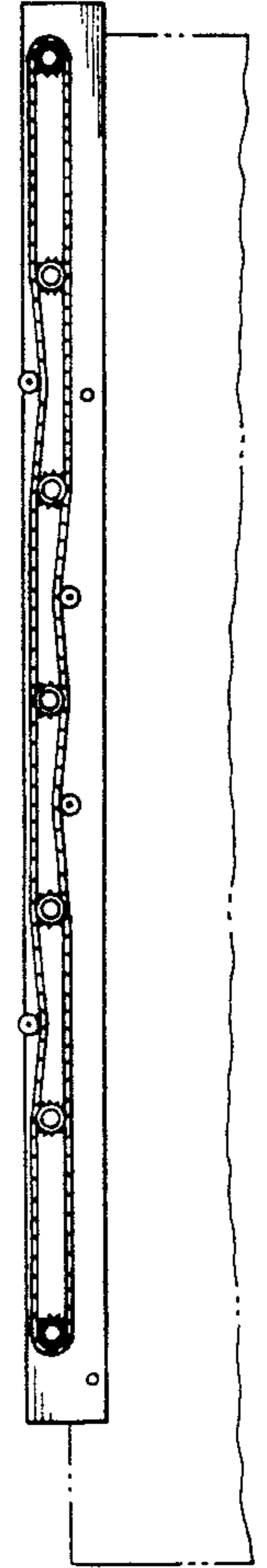

Fig. 4

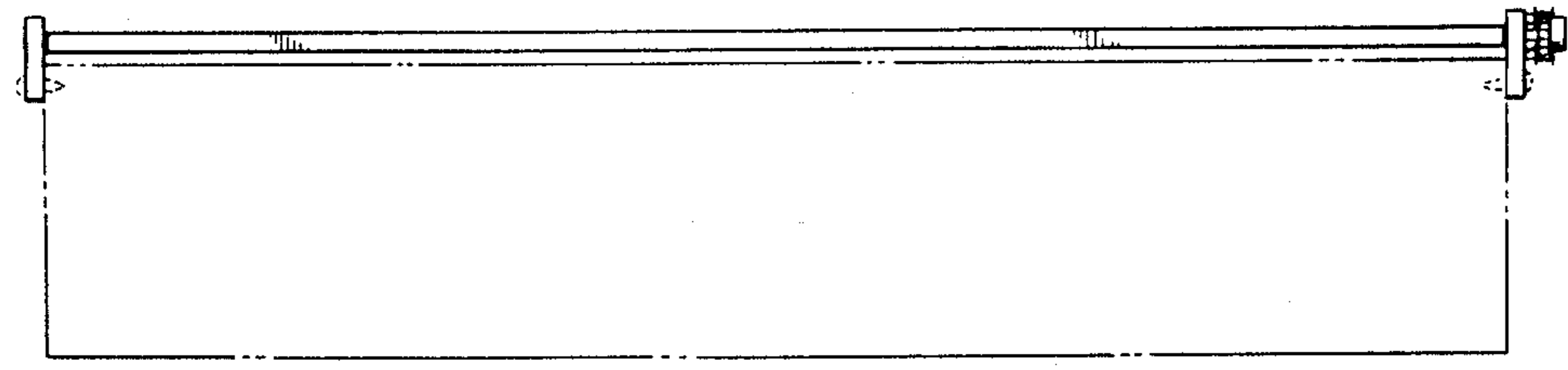

Fig. 6