

[54] TOY DIVER FIGURE WITH HOIST

[75] Inventor: Carlo A. Jensen, Helsingør, Denmark

[73] Assignee: Interlego AG, Baar, Switzerland

[**] Term: 14 Years

[21] Appl. No.: 561,663

[22] Filed: Dec. 15, 1983

[52] U.S. Cl. D21/177

[58] Field of Search D21/177, 166, 150, 148, D21/171; 446/97, 99, 100, 101, 159, 156, 424

[56] References Cited

U.S. PATENT DOCUMENTS

D. 247,054	1/1978	Rahmstorf	D21/150
D. 253,711	12/1979	Christiansen et al.	D21/166
3,364,616	1/1968	Speers	446/159

OTHER PUBLICATIONS

Tropical Fish Handbook Cat., p. 52, center, No. 5330, Diver.

Primary Examiner—Melvin B. Feifer
Attorney, Agent, or Firm—Kane, Dalsimer, Kane, Sullivan and Kurucz

[57] CLAIM

The ornamental design for a toy diver figure with hoist, as shown and described.

DESCRIPTION

FIG. 1 is a front elevation of a toy diver figure with hoist showing my new design;
FIG. 2 is a rear view;
FIG. 3 is a top view;
FIG. 4 is a front perspective view;
FIG. 5 is a side view with the other side being identical;
FIG. 6 is a bottom view.

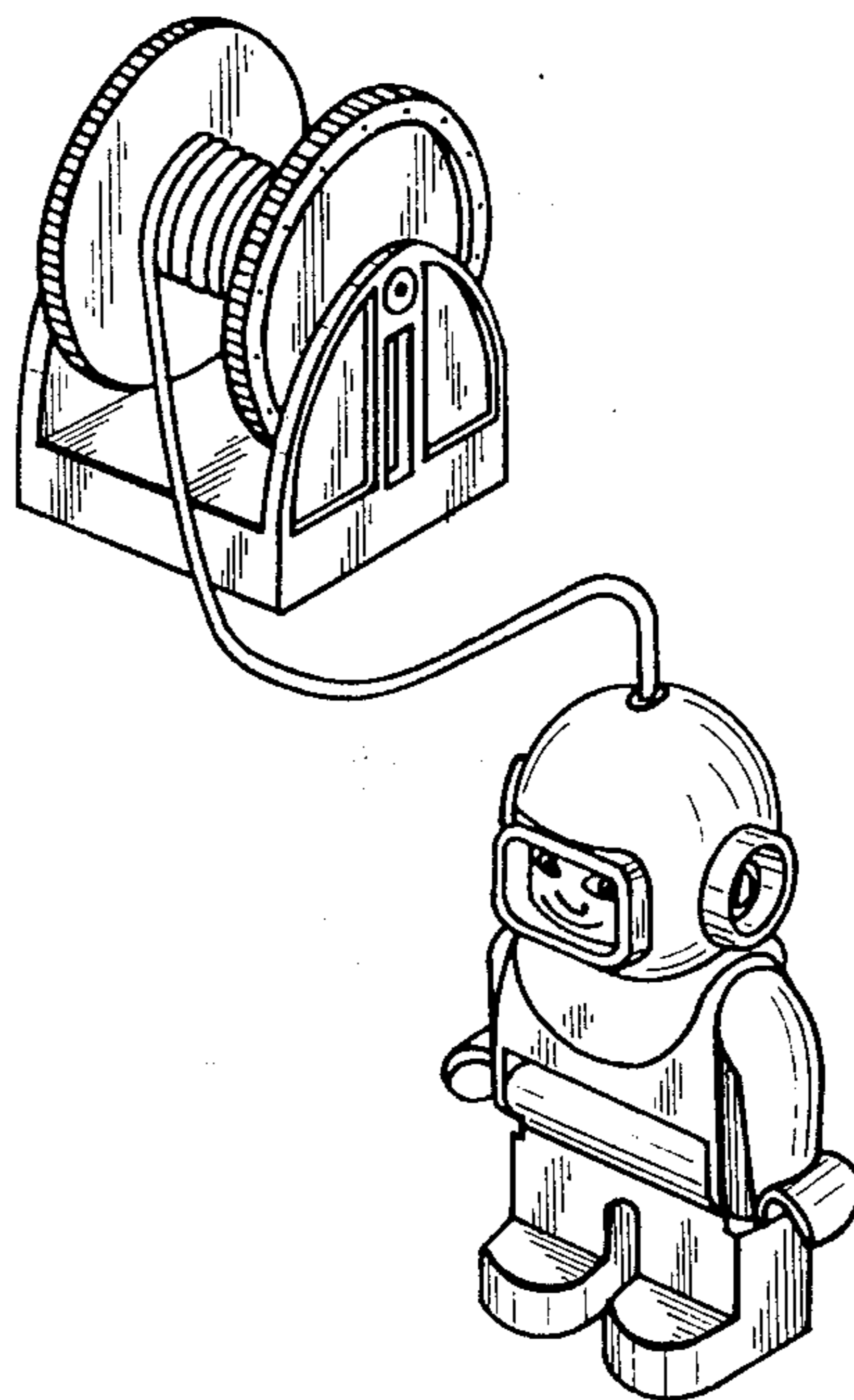

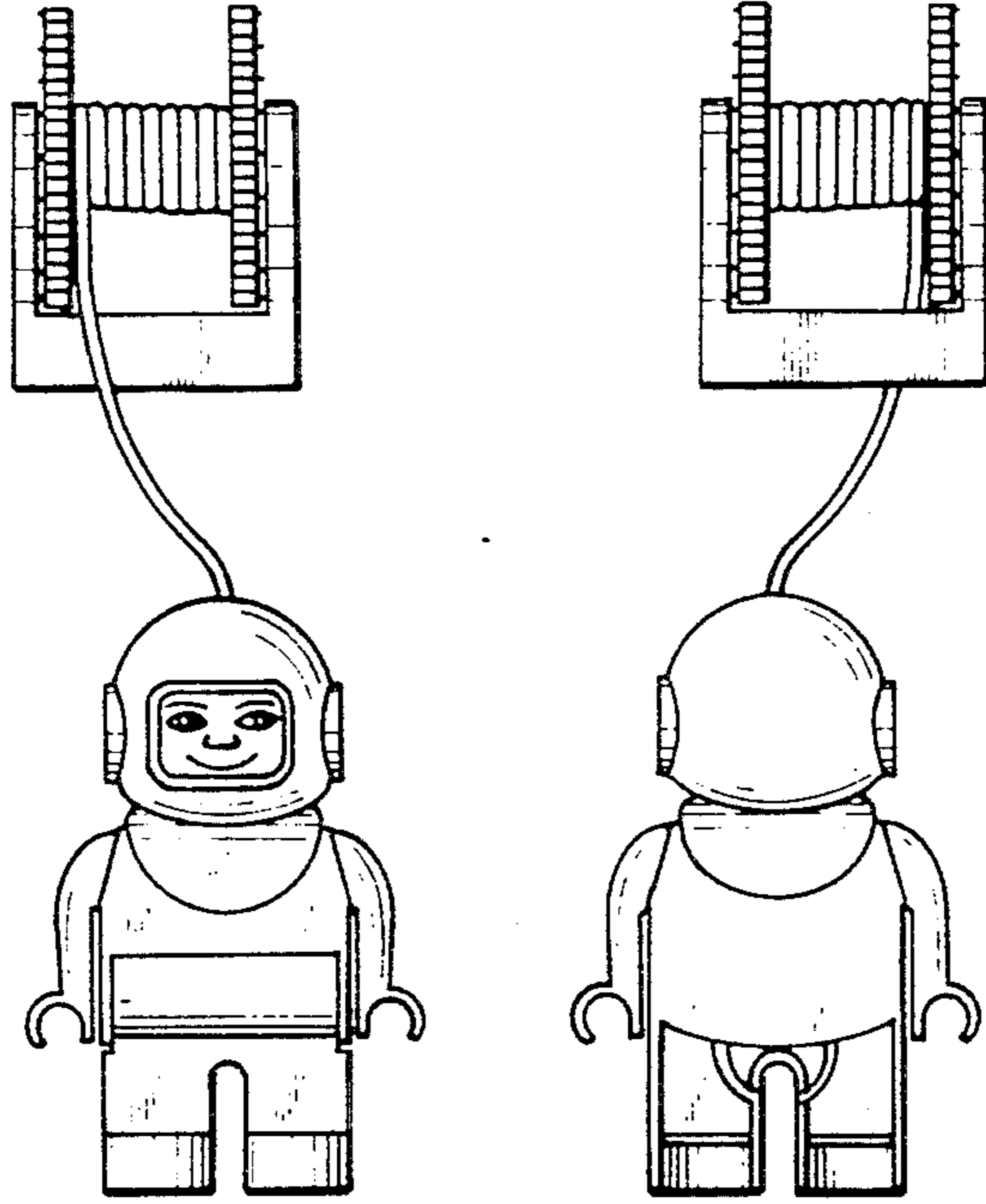

FIG. 1

FIG. 2

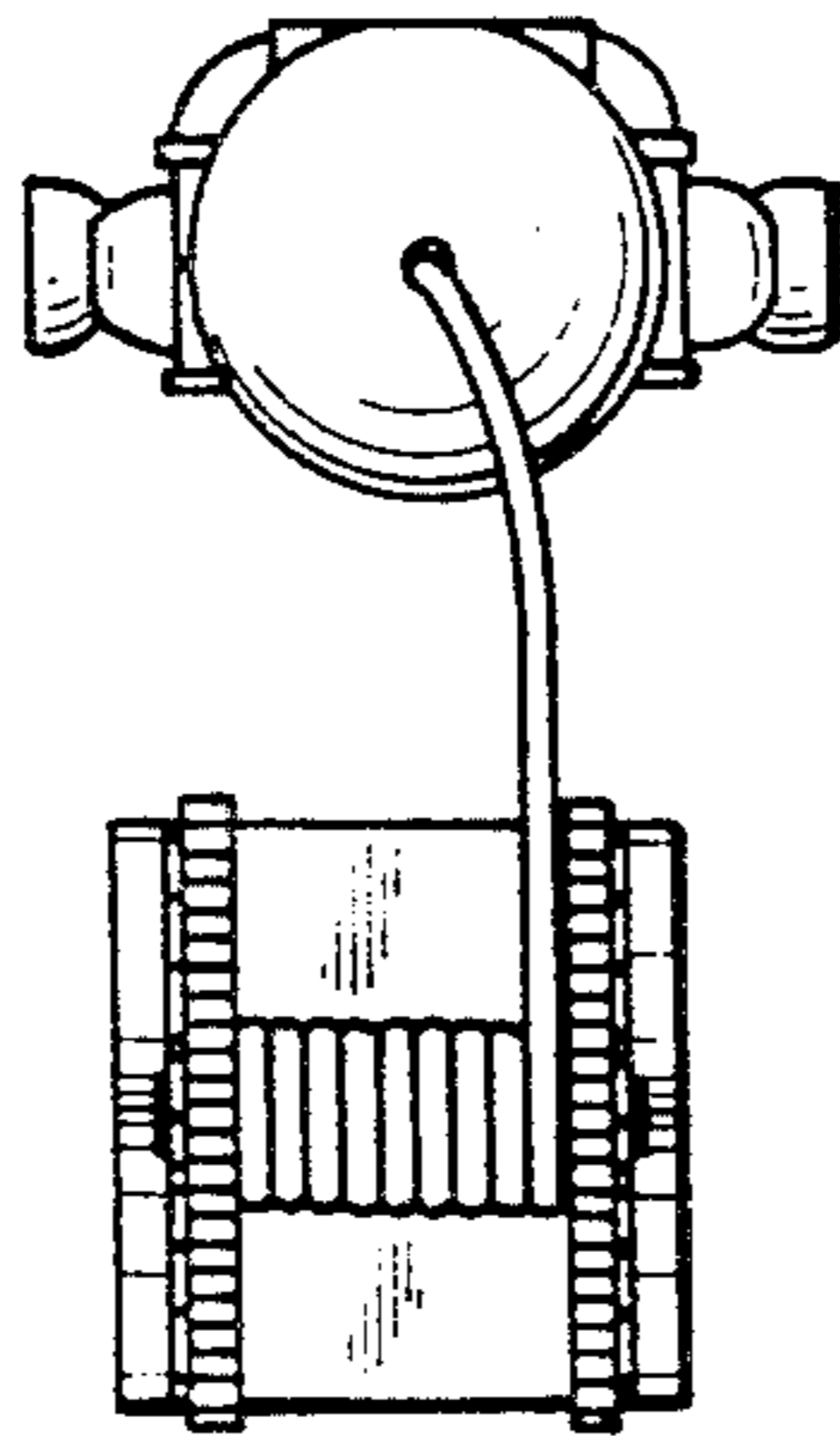

FIG. 3

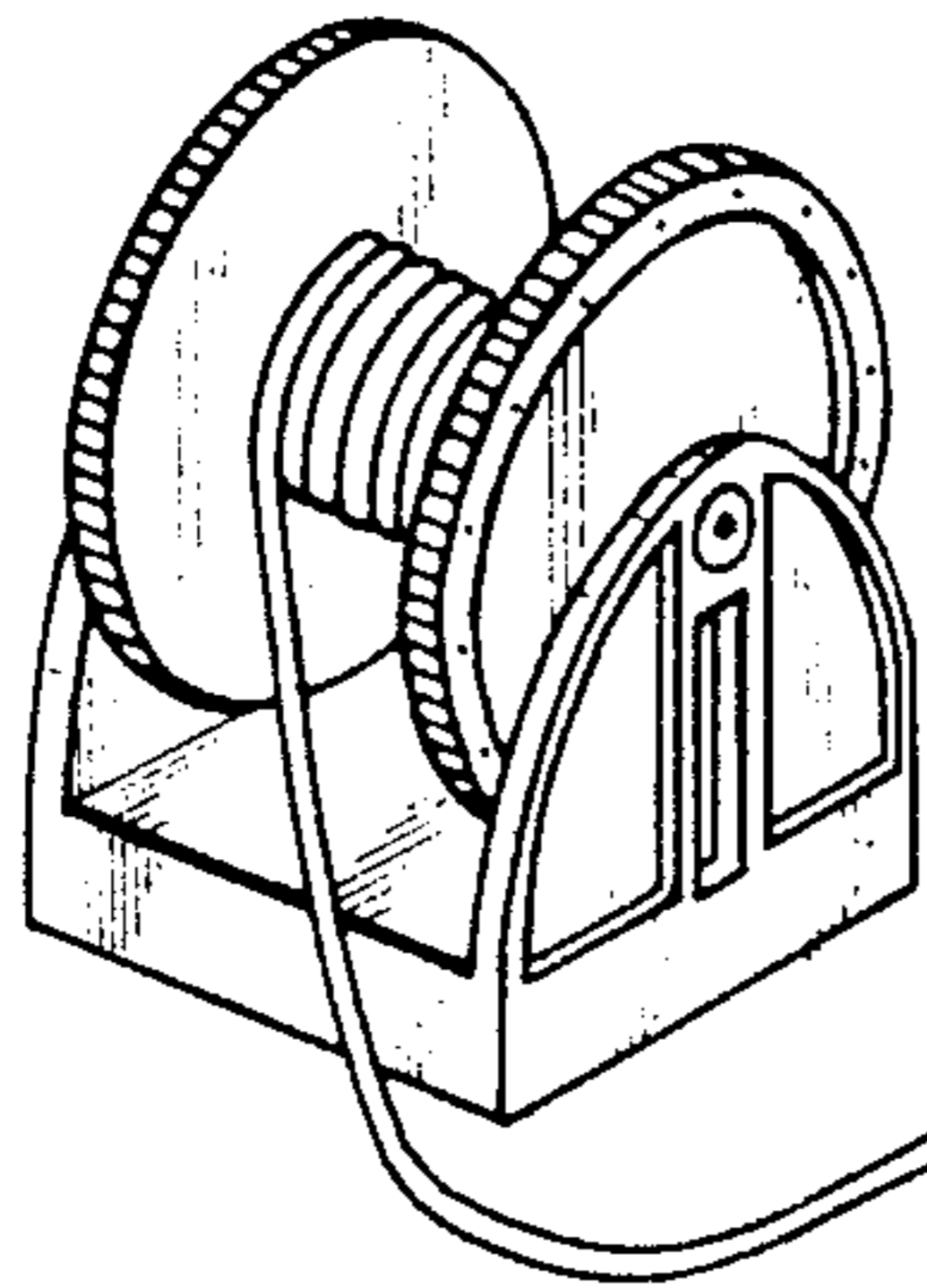

FIG. 4

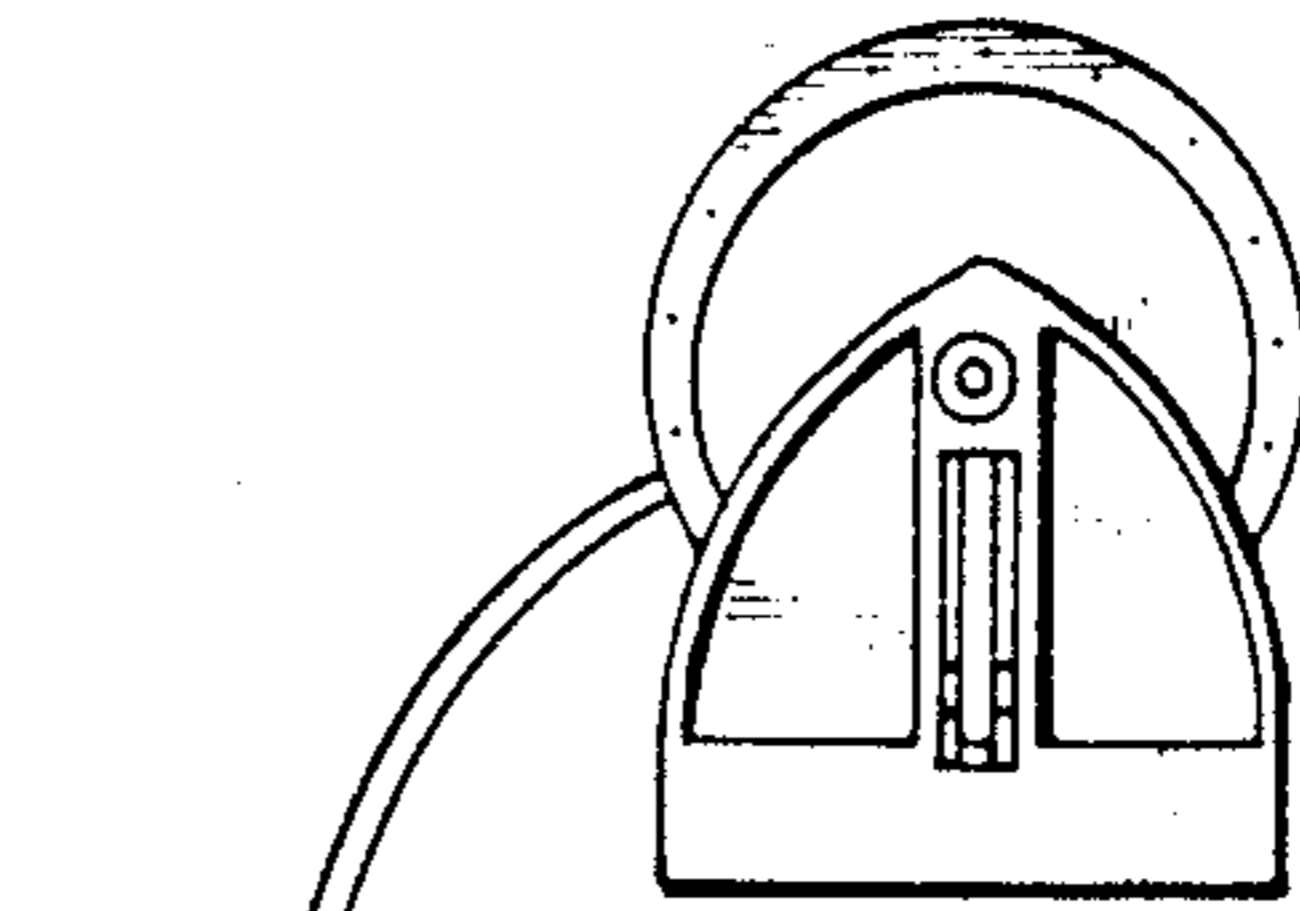
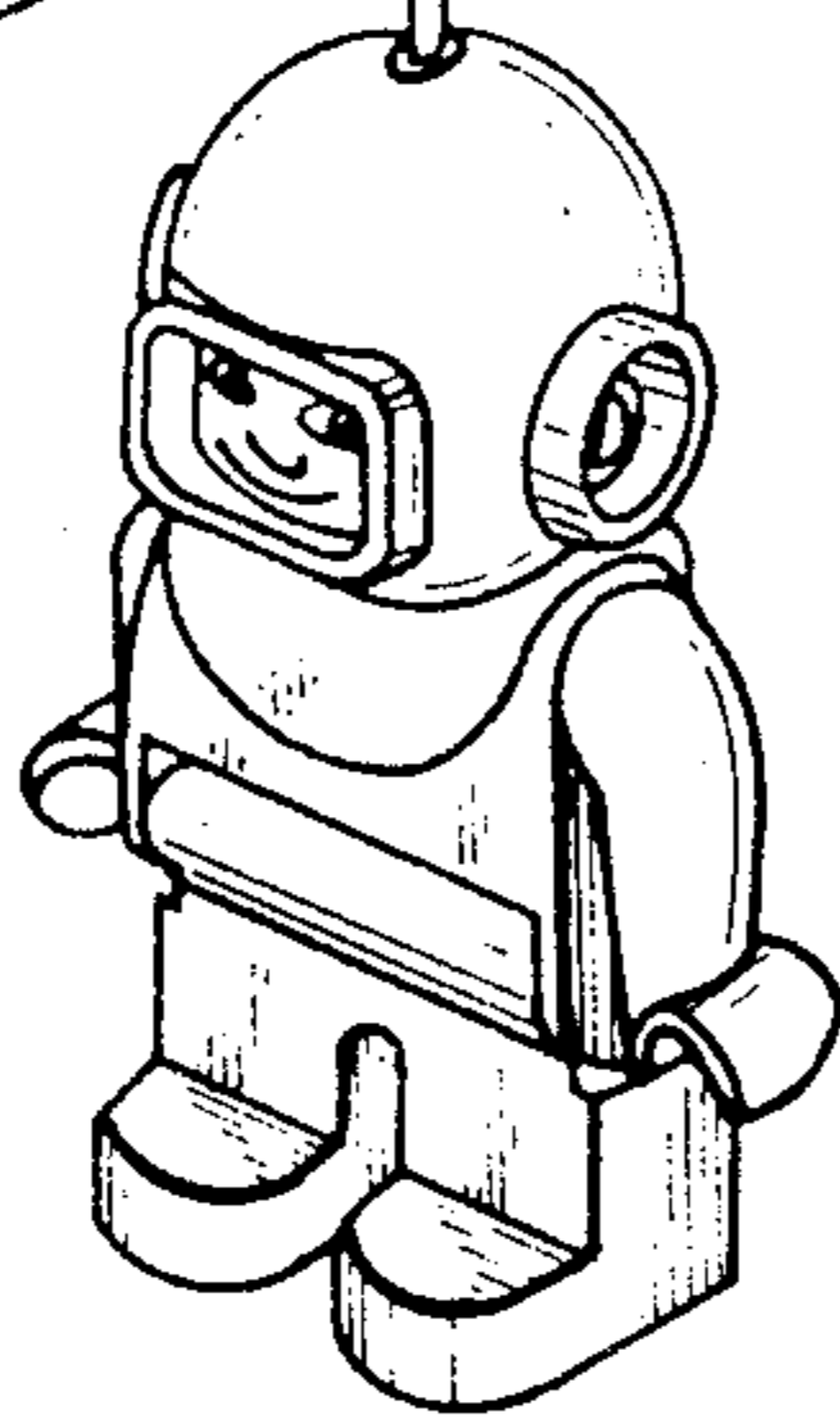

FIG. 5

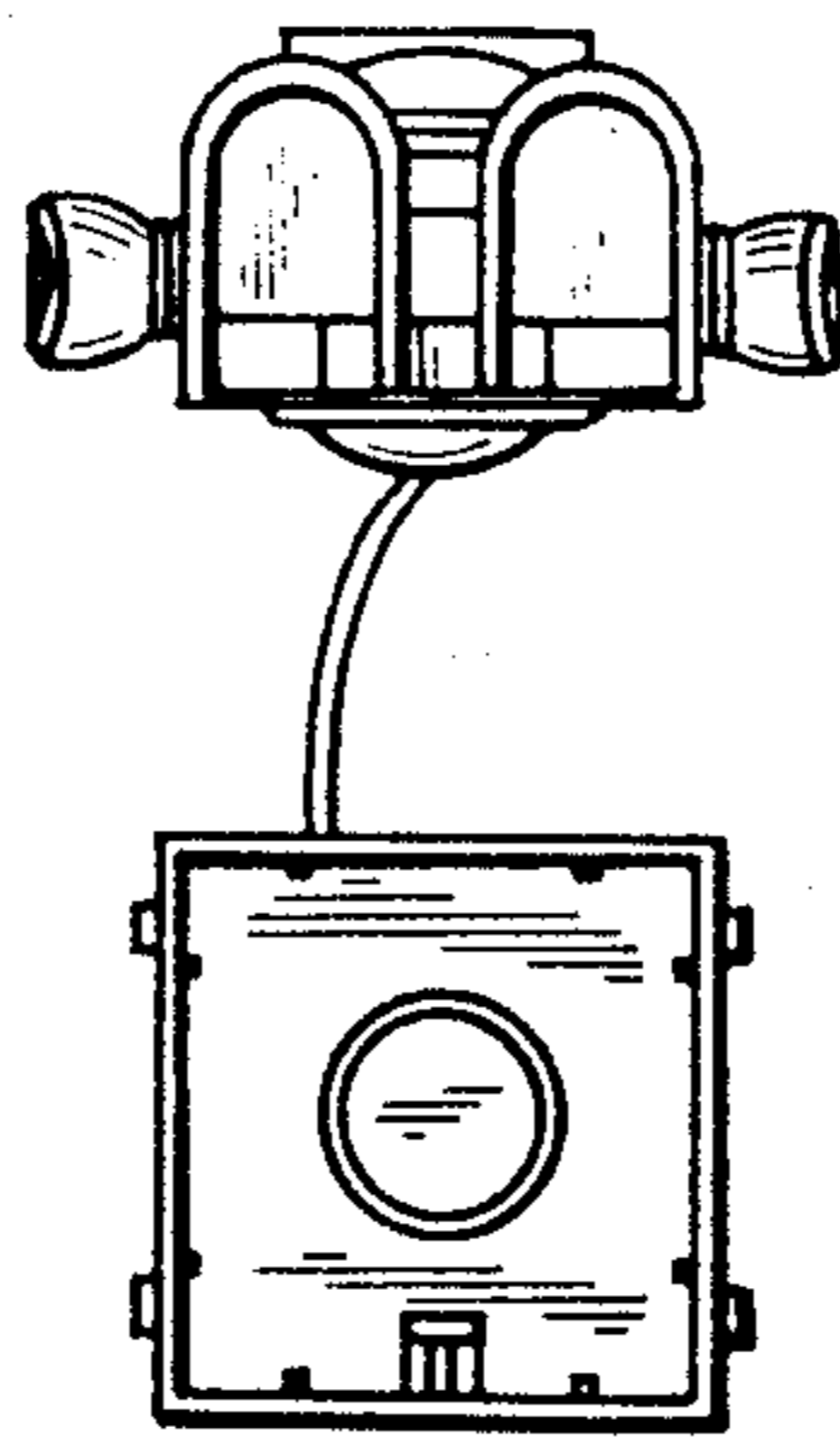
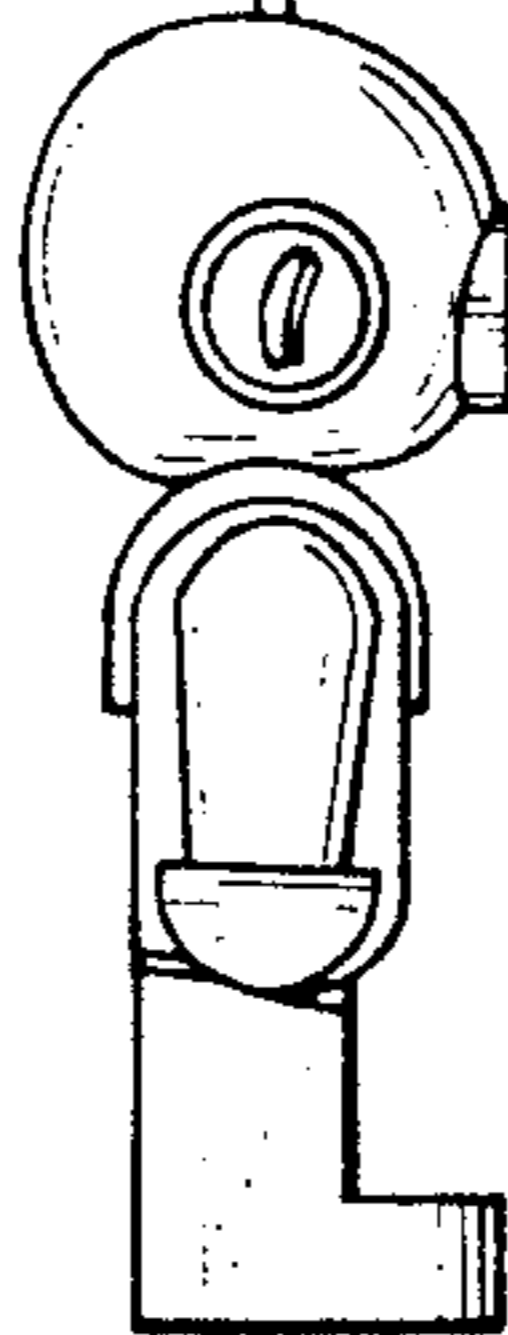

FIG. 6