

[54] LIGHTED MIRROR

[75] Inventor: Ronald Weinhart, Encino, Calif.

[73] Assignee: Hartman Products, Hawthorne, Calif.

[\*\*] Term: 14 Years

[21] Appl. No.: 575,031

[22] Filed: Jan. 30, 1984

[52] U.S. Cl. .... D6/308

[58] Field of Search ..... D28/78, 83; D6/308; 132/79 R, 79 F, 79 G, 83 R, 83 E, DIG. 2; 220/DIG. 26; 362/136, 137

[56] References Cited

U.S. PATENT DOCUMENTS

- D. 255,945 7/1980 MacGregor ..... D6/308
- D. 260,305 8/1981 MacGregor et al. .... D28/83 X
- 3,949,767 4/1976 Rose ..... 132/83 R

Primary Examiner—Louis S. Zarfes  
Attorney, Agent, or Firm—Beehler, Pavitt, Siegemund, Jagger & Martella

[57] CLAIM

The ornamental design for a lighted mirror, as shown and described.

DESCRIPTION

FIG. 1 is a front elevational view of a lighted mirror in a folded condition, showing my new design;  
 FIG. 2 is a right side elevational view;  
 FIG. 3 is a rear elevational view;  
 FIG. 4 is a left side elevational view;  
 FIG. 5 is a top plan elevational view;  
 FIG. 6 is a bottom plan view;  
 FIG. 7 is a perspective view thereof with the front portion position behind the rear portion with its mirror in a tilted condition; and  
 FIG. 8 is a perspective view thereof with the mirror of the front portion disposed in a tilted condition.

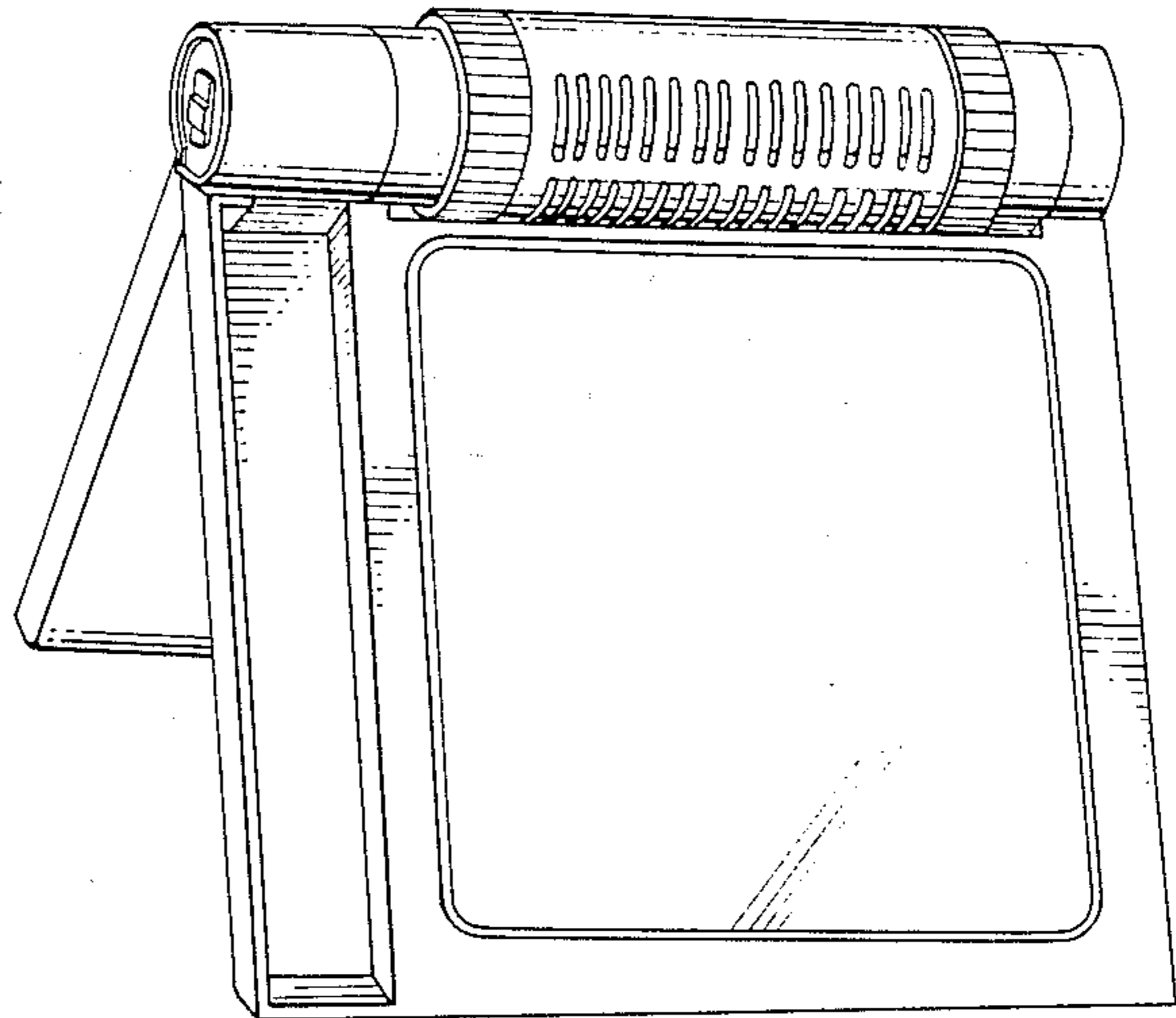
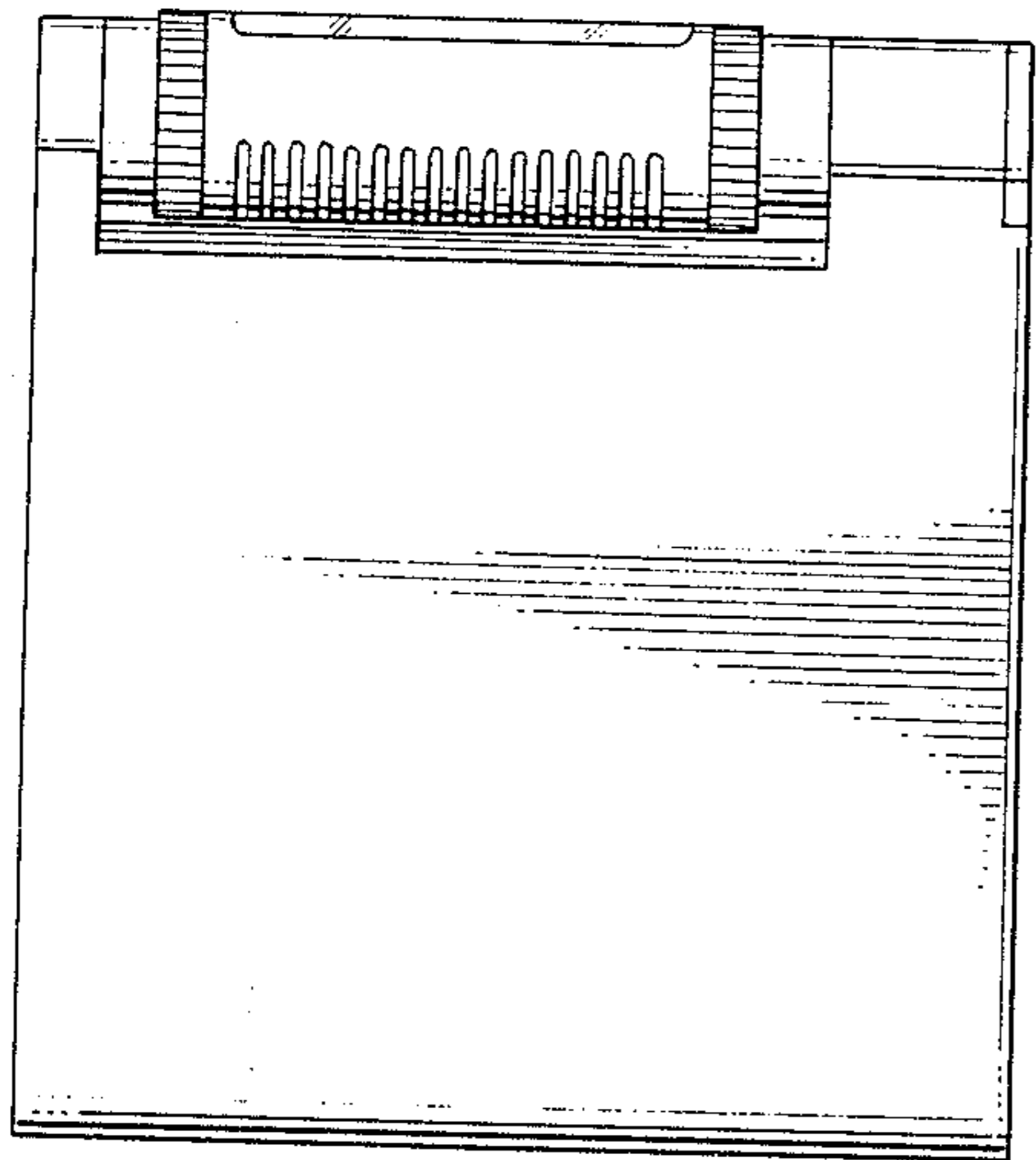

FIG. 1.

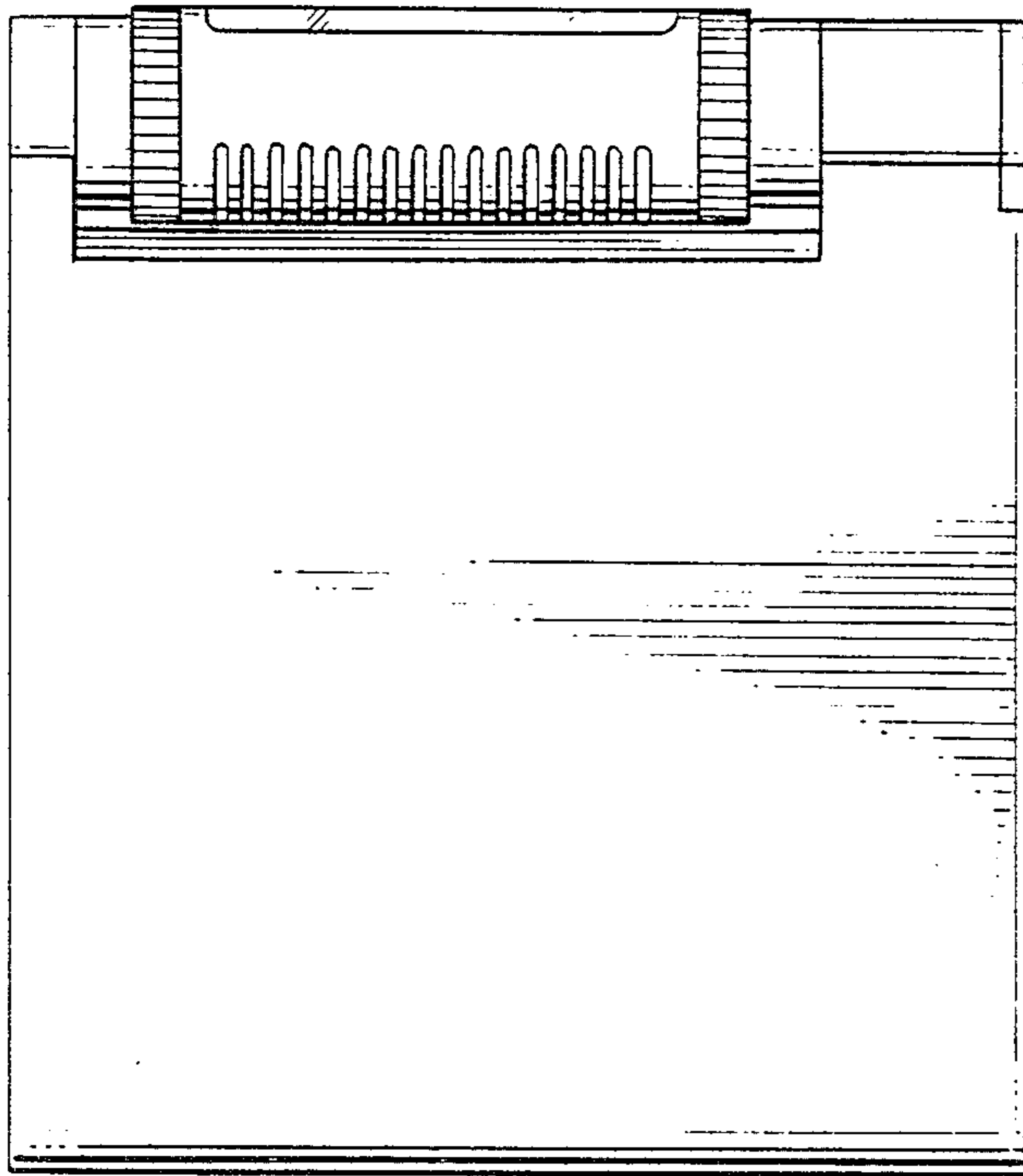

FIG. 2.

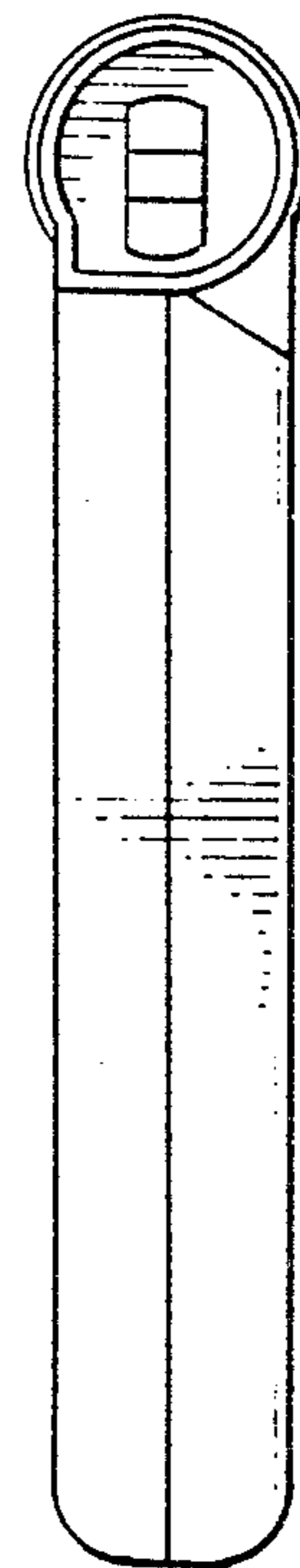

FIG. 3.

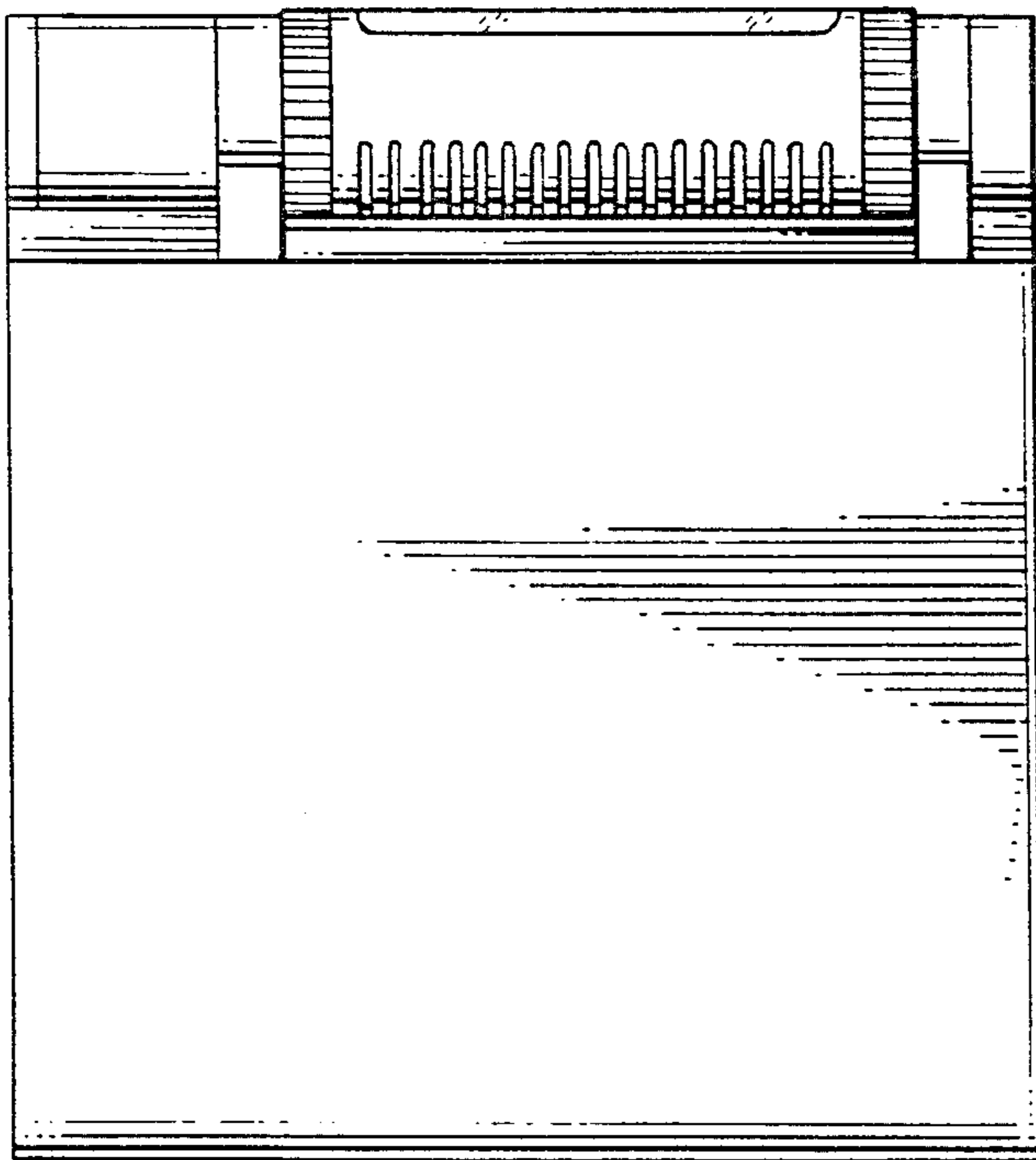
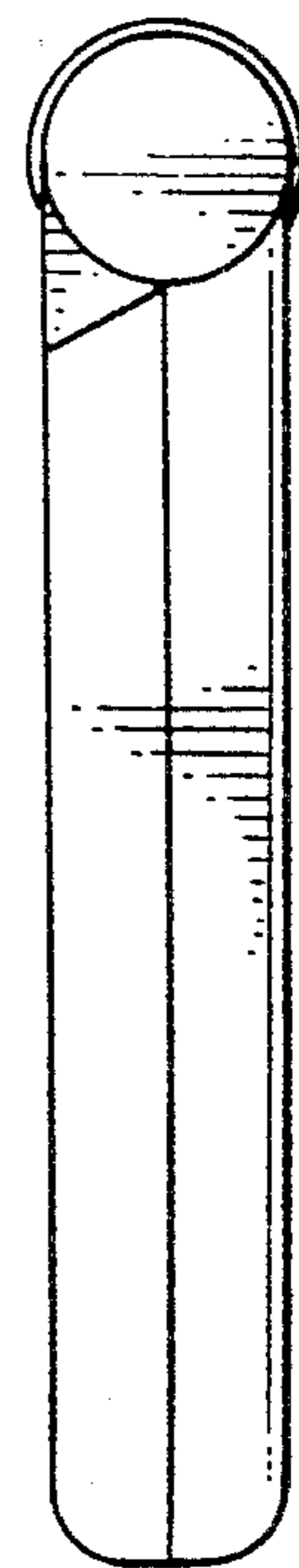
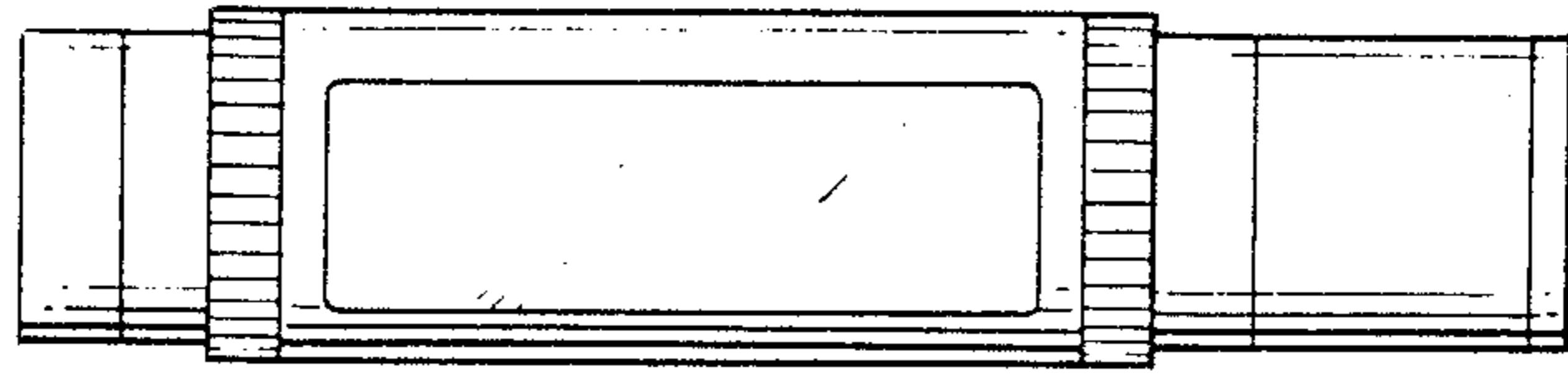

FIG. 4.



*FIG. 5.*



*FIG. 6.*



*FIG. 7.*

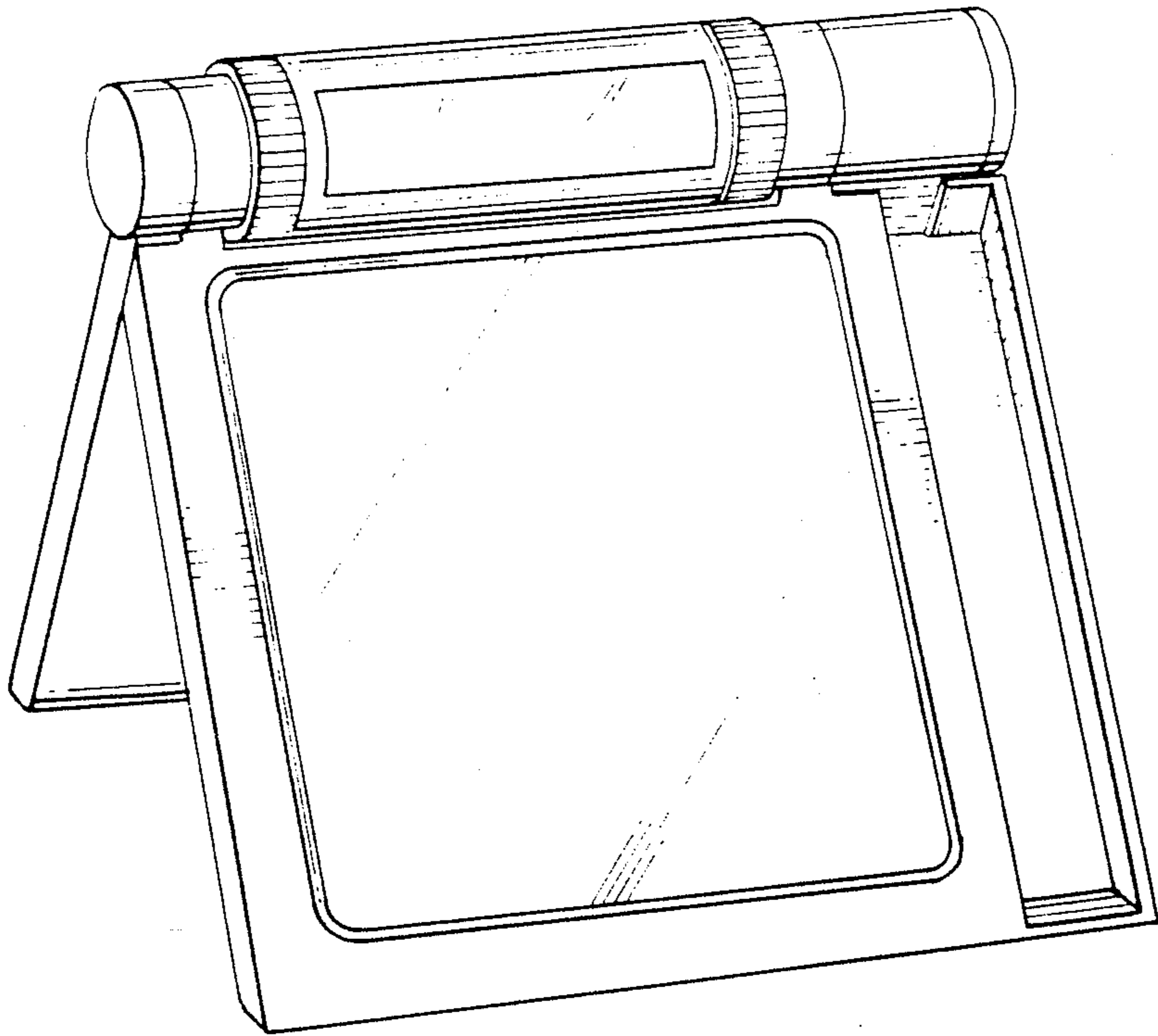

FIG. 8.

