

[54] **COIN BANK OR SIMILAR ARTICLE**

[76] **Inventors: John W. Spirk, Jr., 50 Stonewood Dr.; John R. Nottingham, 60 Stonewood Dr., both of Moreland Hills, Ohio 44022**

[\*\*] **Term: 14 Years**

[21] **Appl. No.: 735,317**

[22] **Filed: May 17, 1985**

[52] **U.S. Cl. .... D99/34**

[58] **Field of Search ..... D99/34, 35, 36, 28; 133/3 C, 3 D, 3 R; 446/8-13; 232/4 R**

[56] **References Cited**

**U.S. PATENT DOCUMENTS**

- D. 103,605 3/1937 Zell .
- D. 161,937 2/1951 Kelly .
- D. 177,002 3/1956 Barker .
- D. 197,786 3/1964 Pierce .
- D. 270,868 10/1983 Spirk .
- 2,749,656 6/1956 Reynolds .

3,143,285 8/1964 Fulton .

3,313,477 4/1967 Brown .

3,387,616 6/1968 Bortz .

3,521,649 7/1970 Warrix .

*Primary Examiner*—Bernard Ansher

*Assistant Examiner*—Terry Pfeffer

*Attorney, Agent, or Firm*—Renner, Otto, Boisselle & Lyon

[57] **CLAIM**

The ornamental design for a coin bank or similar article, as shown and described.

**DESCRIPTION**

FIG. 1 is a three dimensional isometric view of a coin bank or similar article showing our new design;

FIG. 2 is a top plan view thereof;

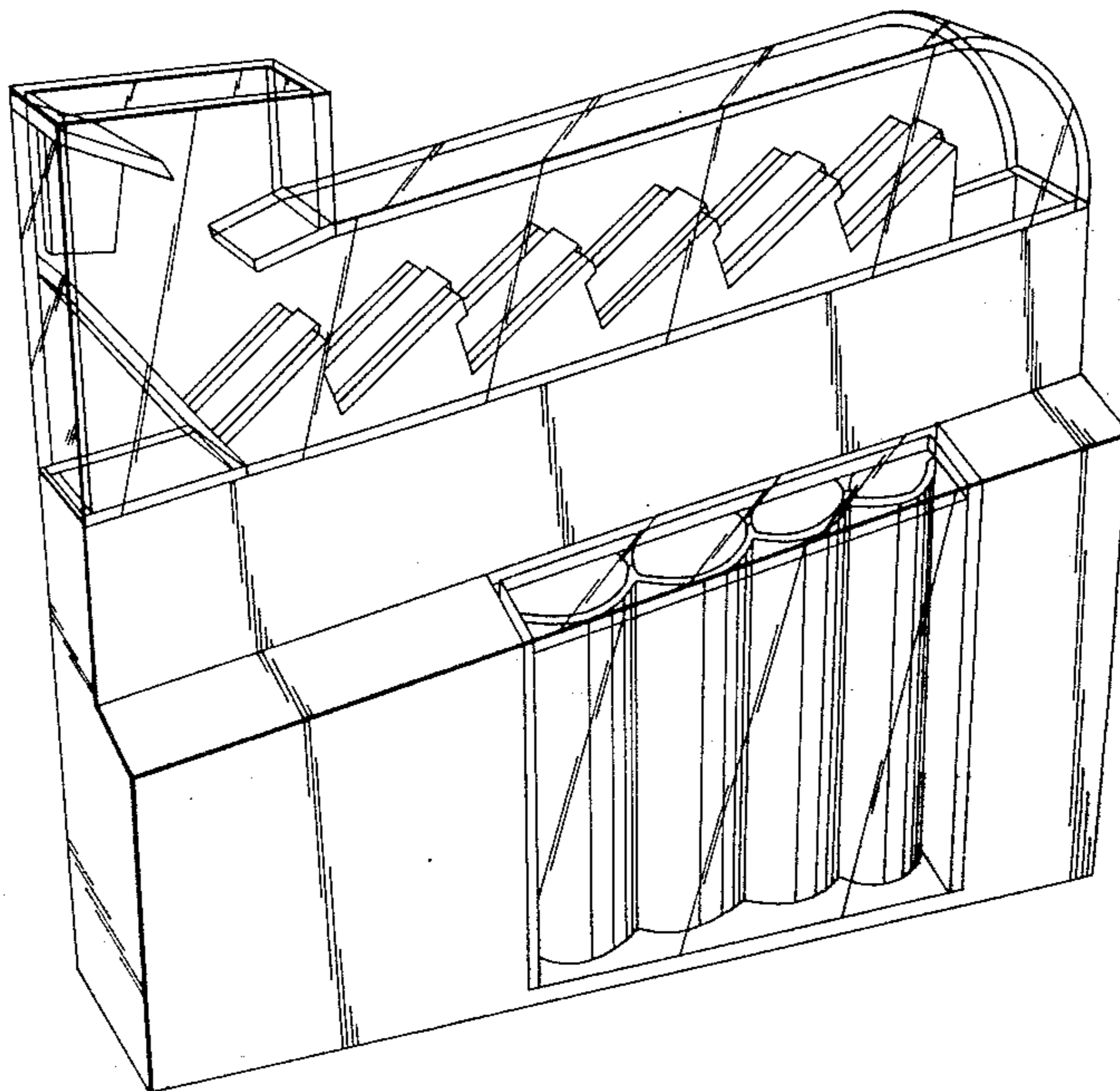
FIG. 3 is a front elevation thereof;

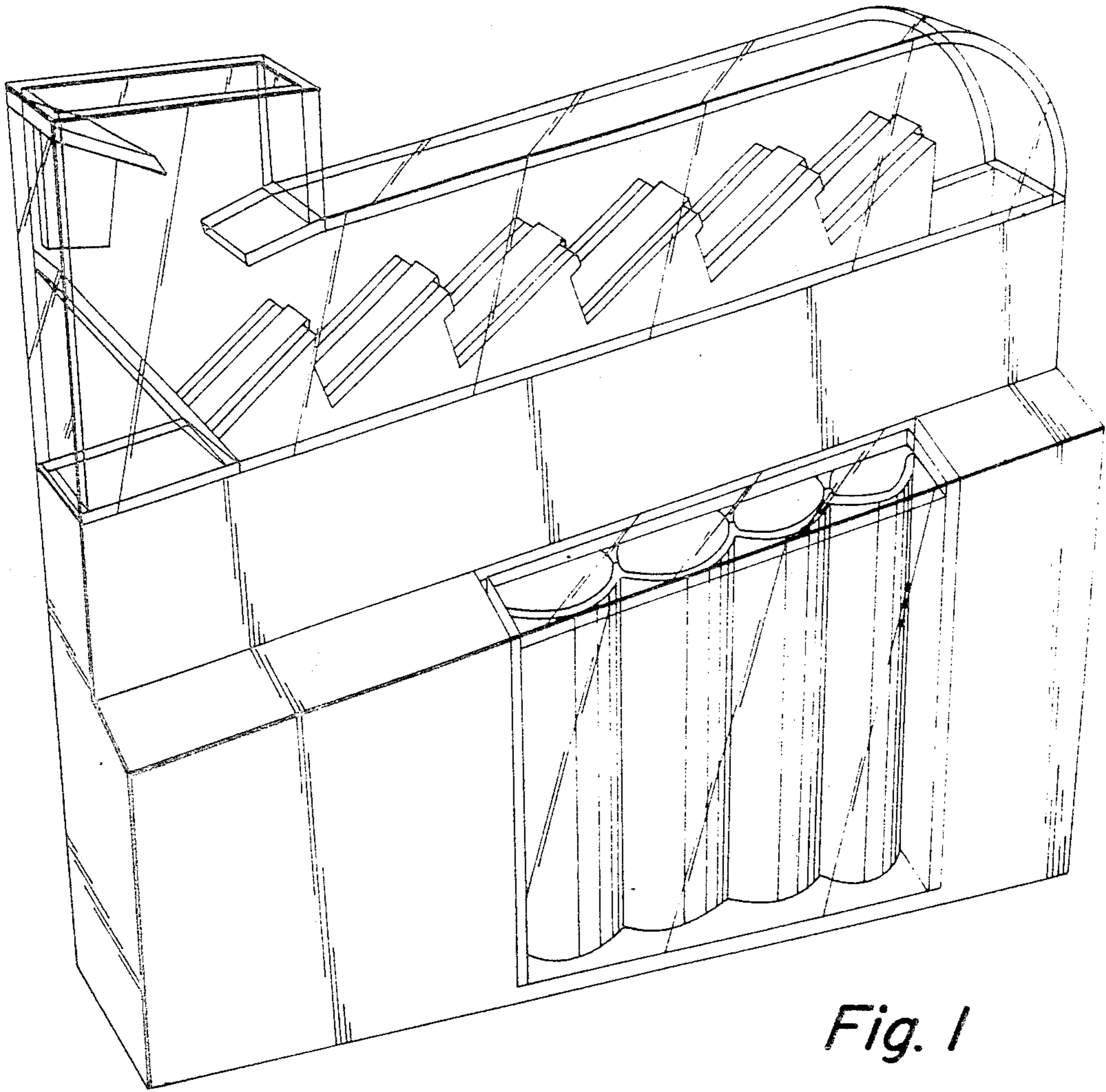
FIG. 4 is a rear elevation thereof;

FIG. 5 is a left side elevation thereof;

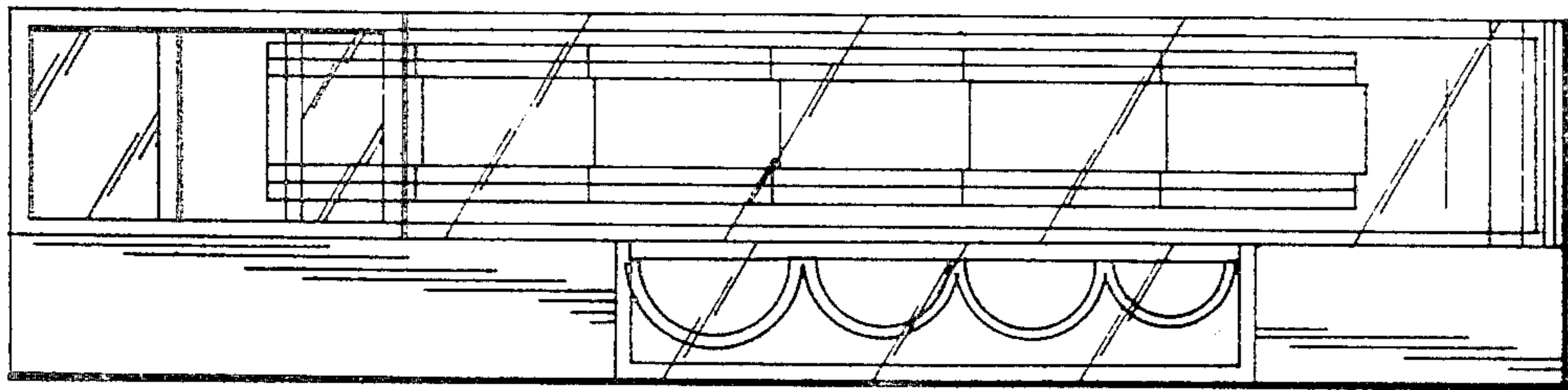
FIG. 6 is a right side elevation thereof; and

FIG. 7 is a bottom plan view thereof.

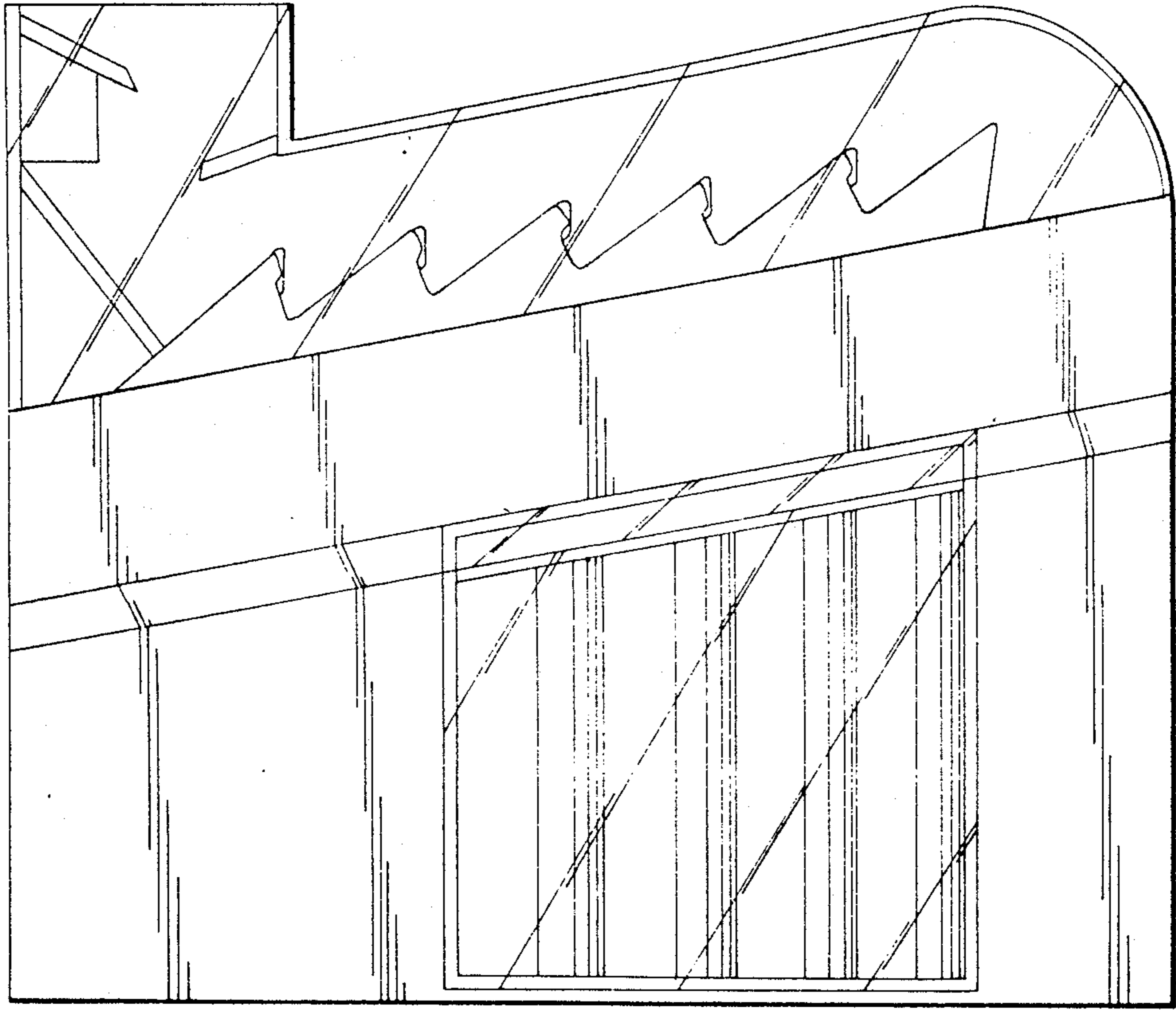




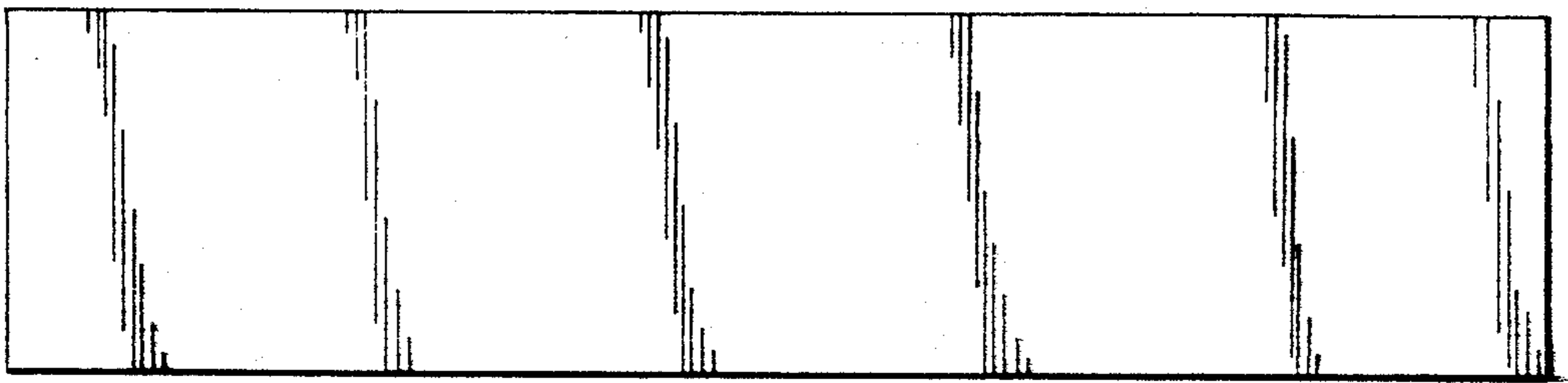
*Fig. 1*



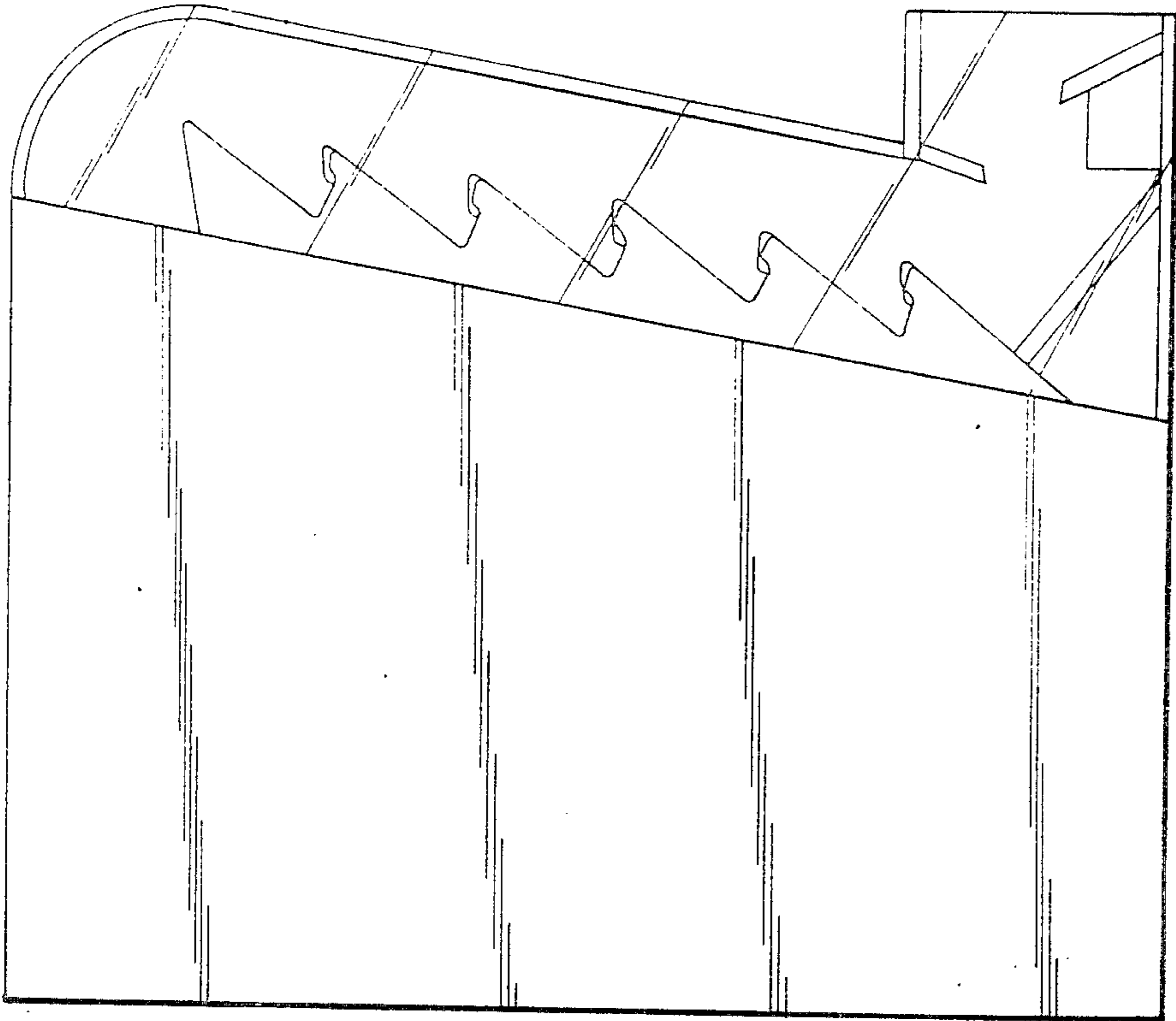
*Fig. 2*



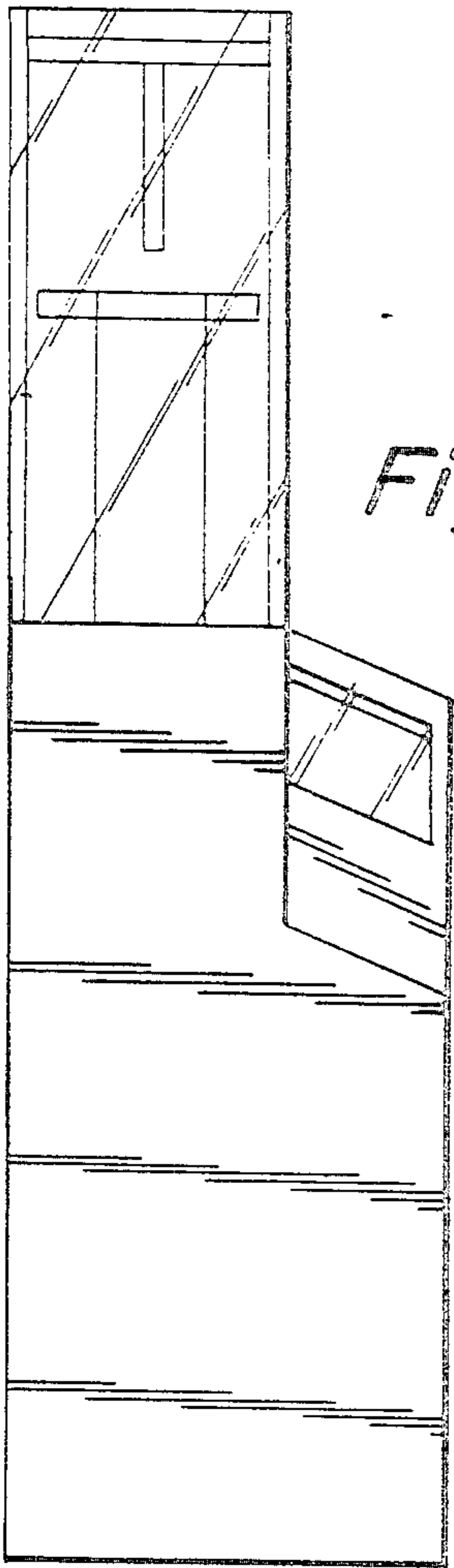
*Fig. 3*



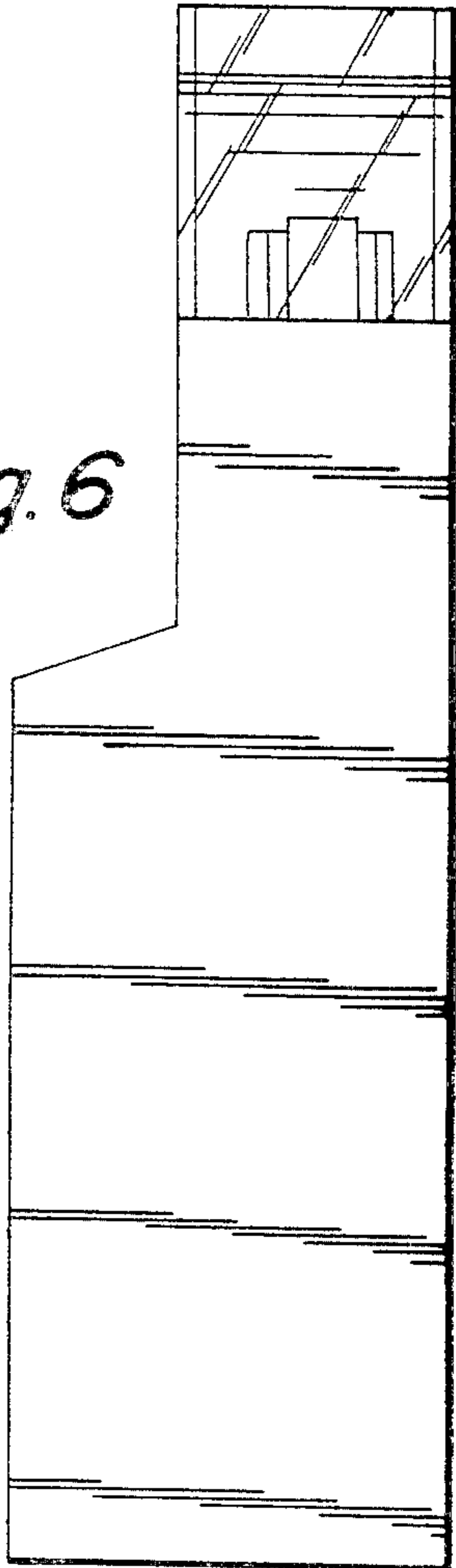
*Fig. 7*



*Fig. 4*



*Fig. 5*



*Fig. 6*