

[54] WATCH

[75] Inventors: Susumu Suzuki; Noritaka Uchihori; Naoto Fukasawa, all of Suwa, Japan

[73] Assignee: Kabushi Kaisha Suwa Seikosha, Tokyo, Japan

[**] Term: 14 Years

[21] Appl. No.: 516,417

[22] Filed: Jul. 22, 1983

[30] Foreign Application Priority Data

Jan. 22, 1983 [JP] Japan 58-2179

[52] U.S. Cl. D10/38

[58] Field of Search D10/30-32, D10/38, 39, 128; 368/281-283, 285, 278

[56] References Cited

U.S. PATENT DOCUMENTS

- D. 263,452 3/1982 Wada D10/38
- D. 267,548 1/1983 Wada D10/38

- D. 269,767 7/1983 Houlihan et al. D10/38
- D. 269,951 8/1983 Eberhardt et al. D10/38
- D. 271,473 11/1983 Dobashi D10/38

Primary Examiner—Louis S. Zarfes
Attorney, Agent, or Firm—Blum, Kaplan, Friedman, Silberman & Beran

[57] CLAIM

The ornamental design for a watch, as shown and described.

DESCRIPTION

FIG. 1 is a top plan view of a watch showing our new design;
 FIG. 2 is a front elevational view thereof;
 FIG. 3 is a left side elevational view thereof;
 FIG. 4 is a right side elevational view thereof;
 FIG. 5 is a bottom plan view thereof;
 FIG. 6 is a rear elevational view thereof;
 FIG. 7 is a perspective view thereof; and
 FIG. 8 is a front elevational view thereof with the digital display in an energized condition.

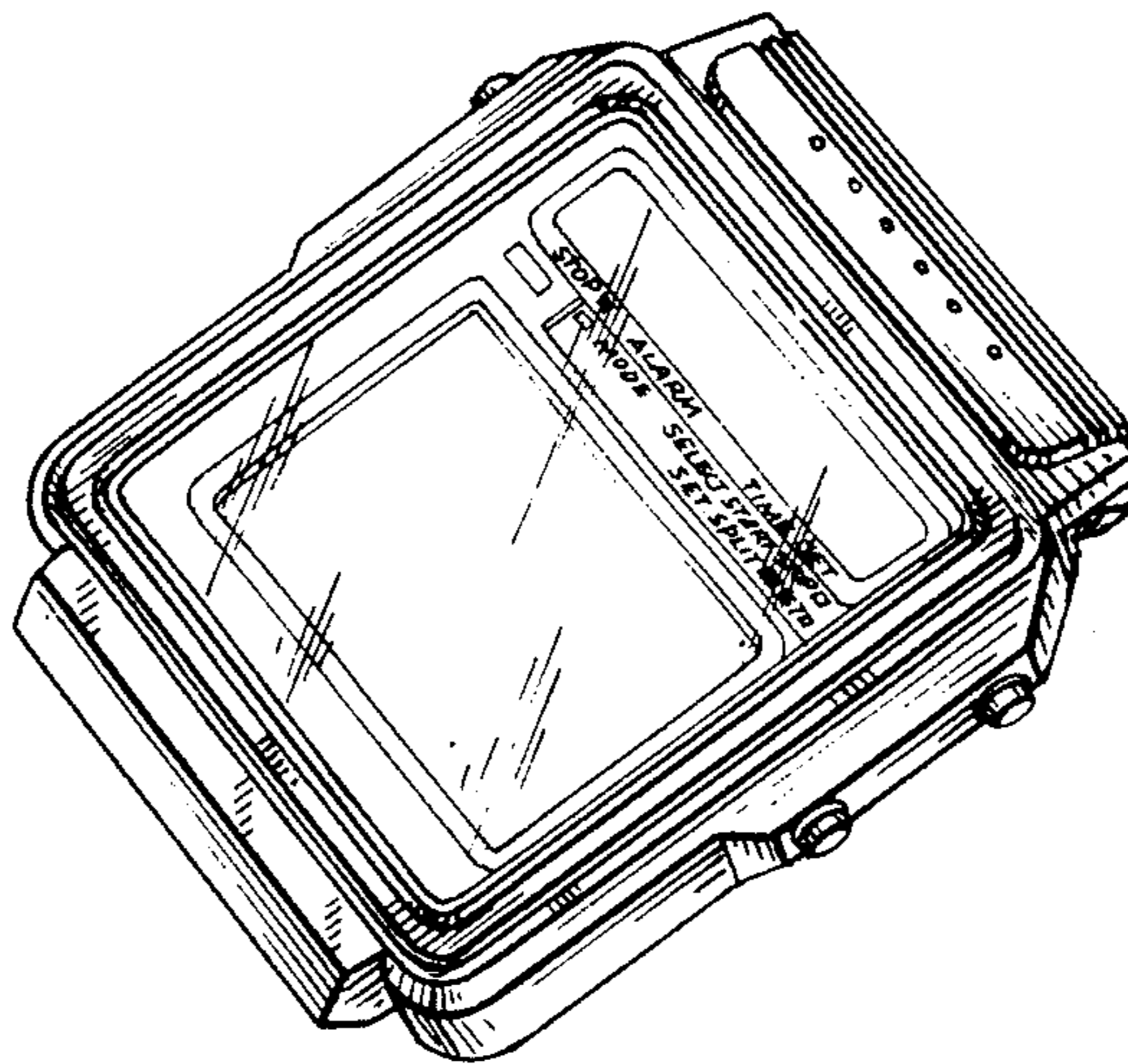

FIG. 1

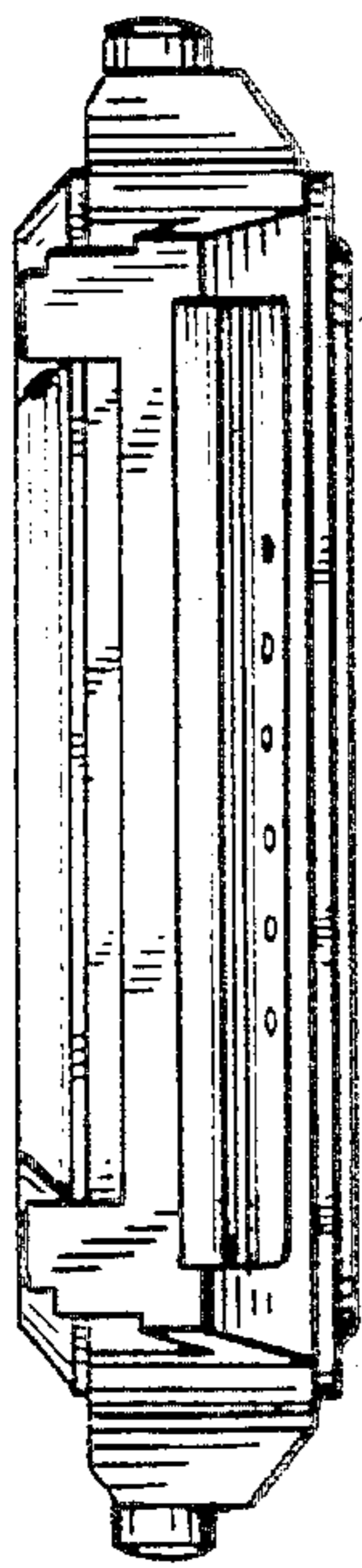

FIG. 3

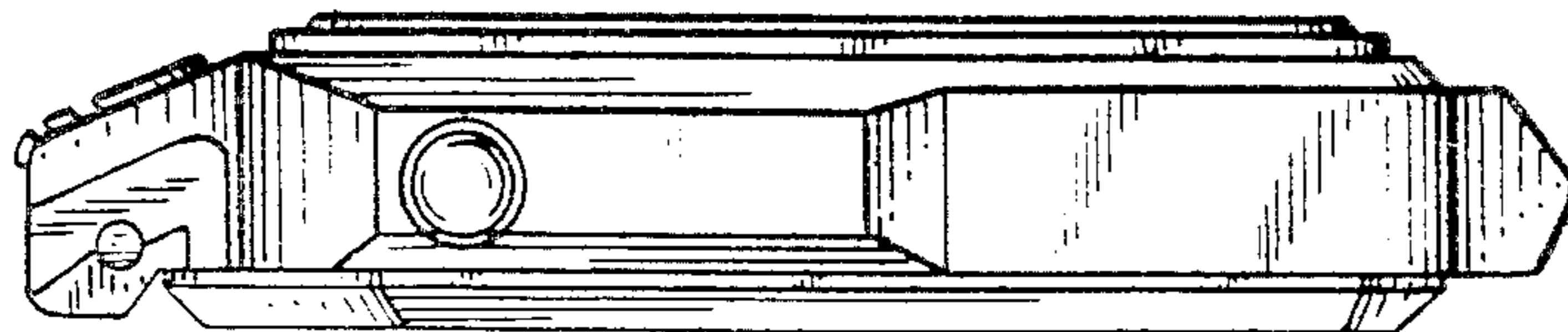

FIG. 2

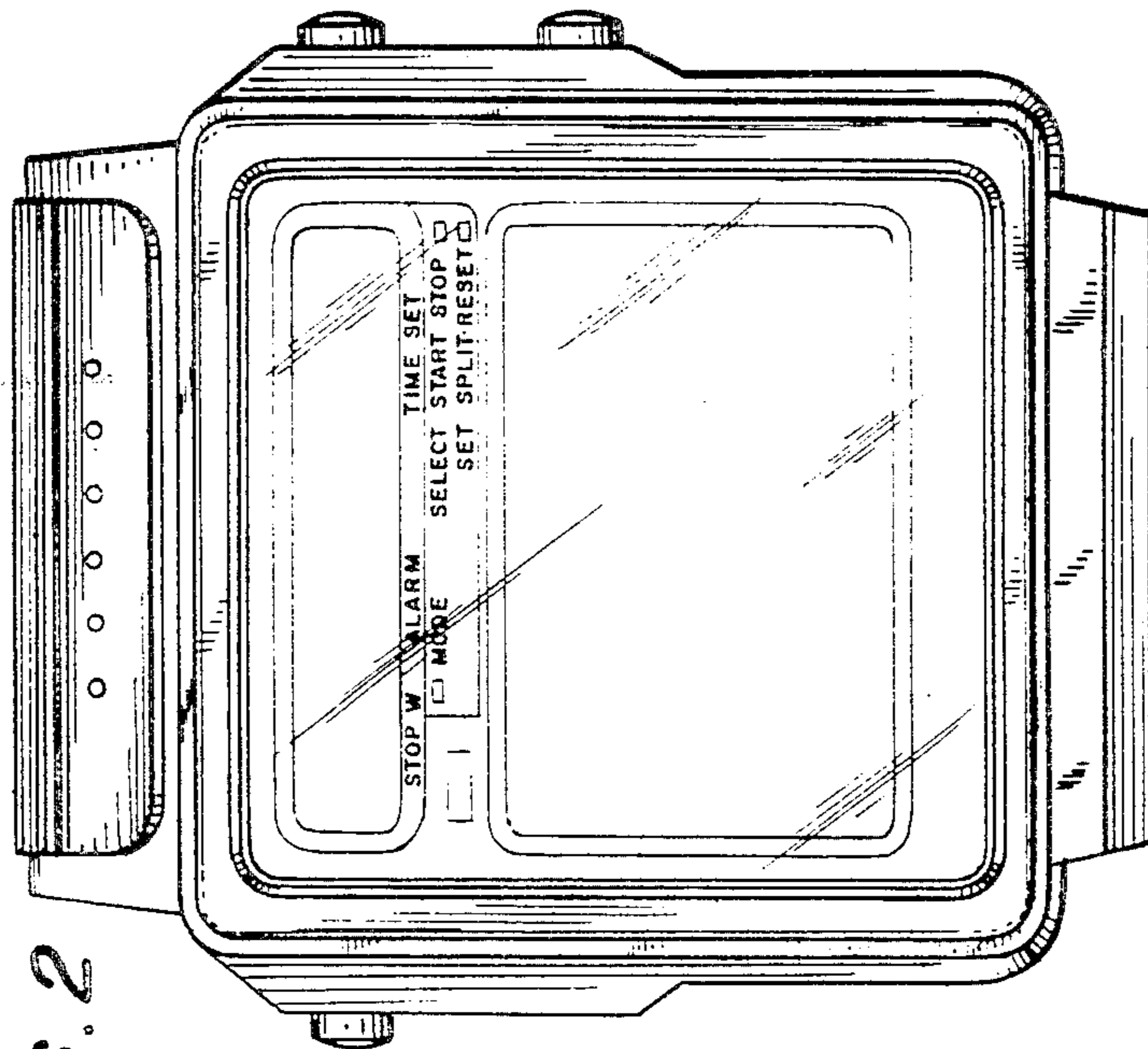

FIG. 4

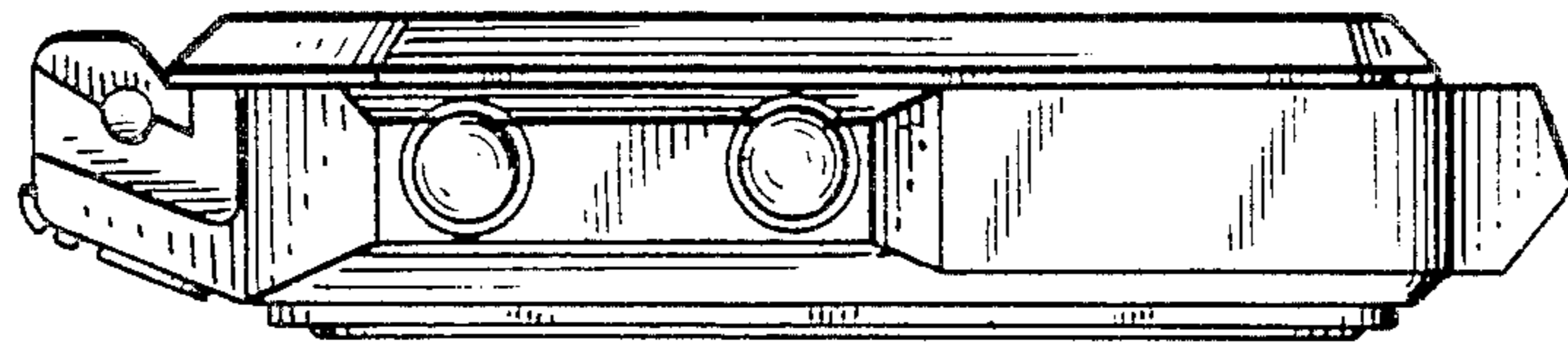

FIG. 5

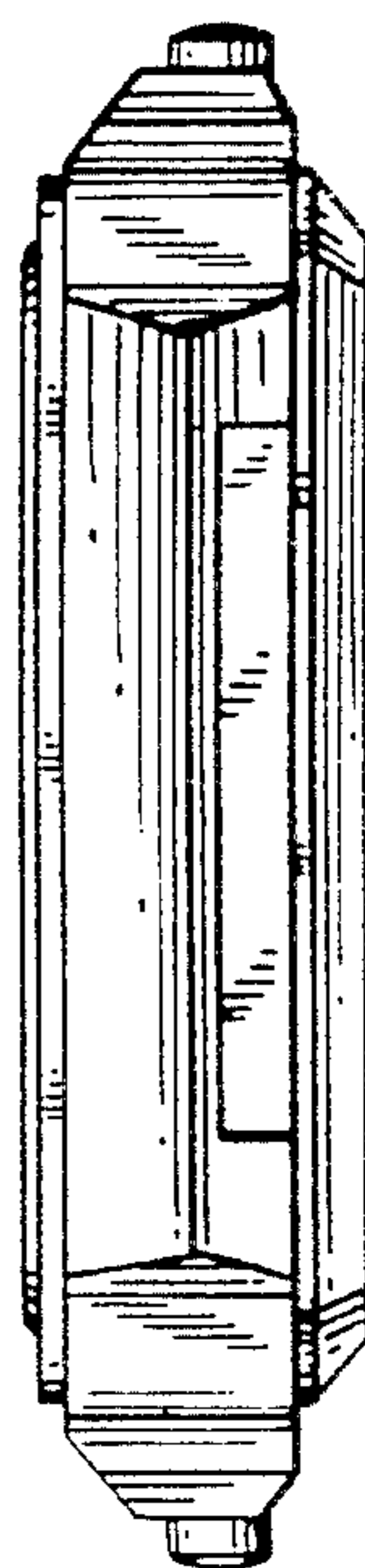

FIG. 7

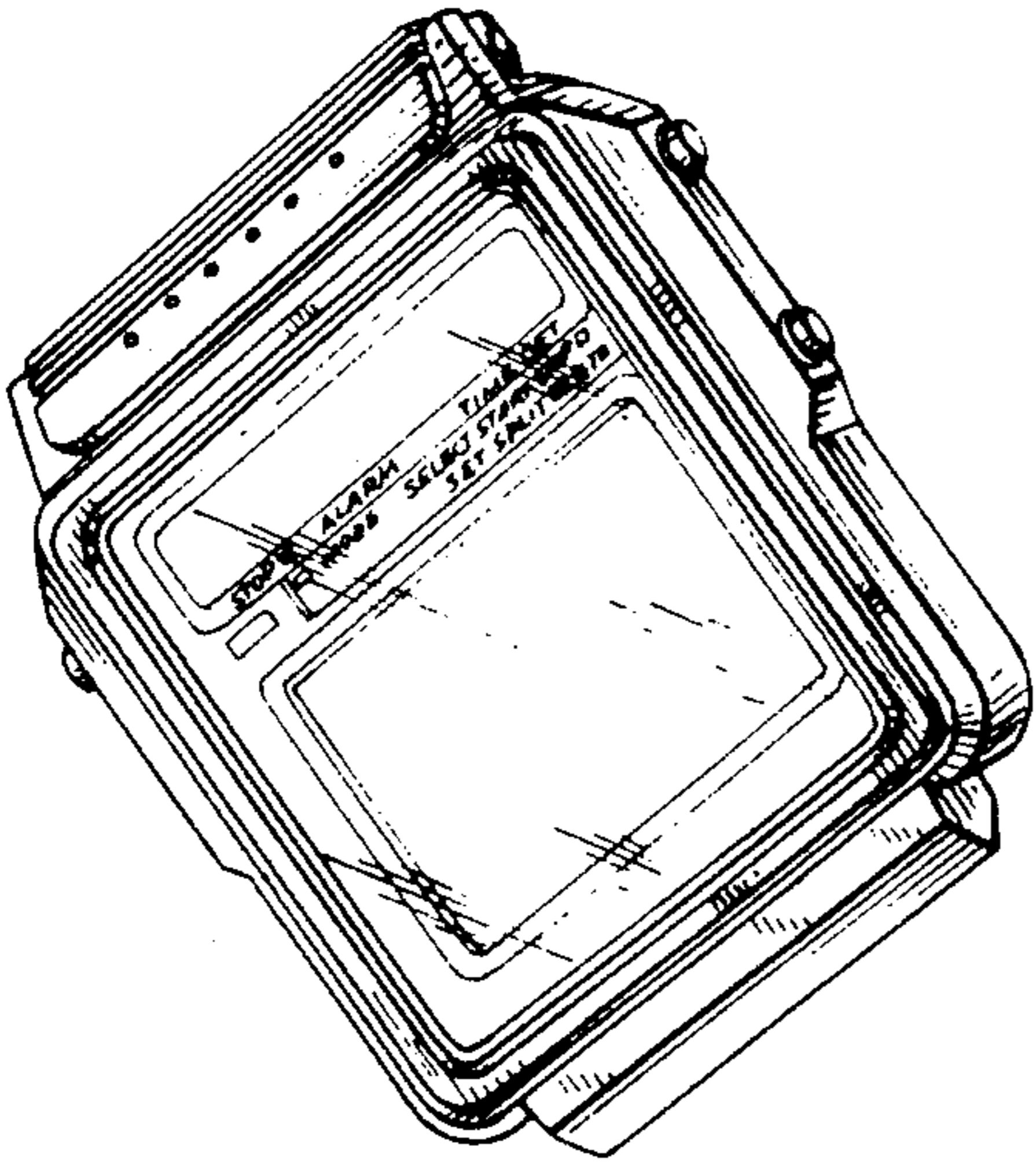

FIG. 8

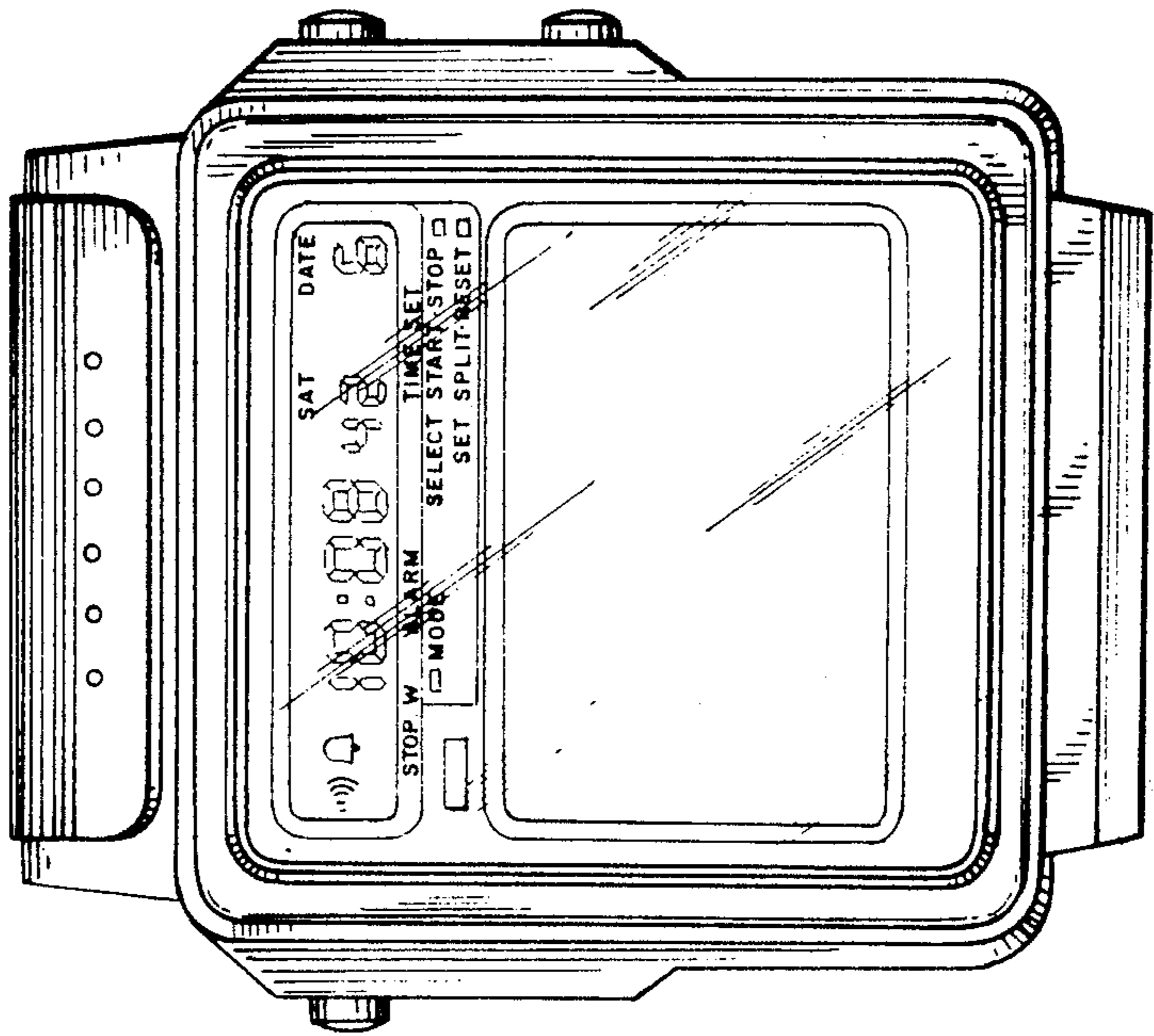

FIG. 6

