

[54] BATHTUB

[75] Inventor: Andrew L. Alger, Wilmette, Ill.

[73] Assignee: Household International, Inc.,  
Prospect Heights, Ill.

[\*\*] Term: 14 Years

[21] Appl. No.: 476,597

[22] Filed: Mar. 18, 1983

[52] U.S. Cl. .... D23/55

[58] Field of Search ..... D23/48, 49, 55-57;  
4/571, 576, 577, 612

2,057,188	10/1936	Stanton	.....	4/577	X
2,269,420	1/1942	Anderson et al.	.....	4/577	
2,436,903	3/1948	Schafer	.....	4/577	X
2,464,645	3/1949	Lassa	.....	4/577	X
2,564,190	8/1951	Danielson	.....	4/577	X

Primary Examiner—James R. Largen  
Attorney, Agent, or Firm—Parmelee, Miller, Welsh &  
Kratz

[57] CLAIM

The ornamental design for a bath tub, as shown and described.

DESCRIPTION

FIG. 1, is a top plan view of a bath tub showing my design;  
FIG. 2 is a front elevational view thereof;  
FIG. 3 is a right end elevational view thereof;  
FIG. 4 is a rear elevational view thereof;  
FIG. 5 is a left end elevational view thereof;  
FIG. 6 is a bottom plan view thereof; and  
FIG. 7 is a perspective view taken from the top, front and left end thereof.

[56] References Cited  
U.S. PATENT DOCUMENTS

D. 86,935	5/1932	Sakier	.....	D23/55
D. 93,716	10/1934	Hesler	.....	D23/55
D. 211,877	8/1968	Doman	.....	D23/55
D. 255,262	6/1980	Beddome et al.	.....	D23/55
D. 265,582	7/1982	Kohler, Jr.	.....	D23/55
D. 275,782	10/1984	Burgess et al.	.....	D23/55

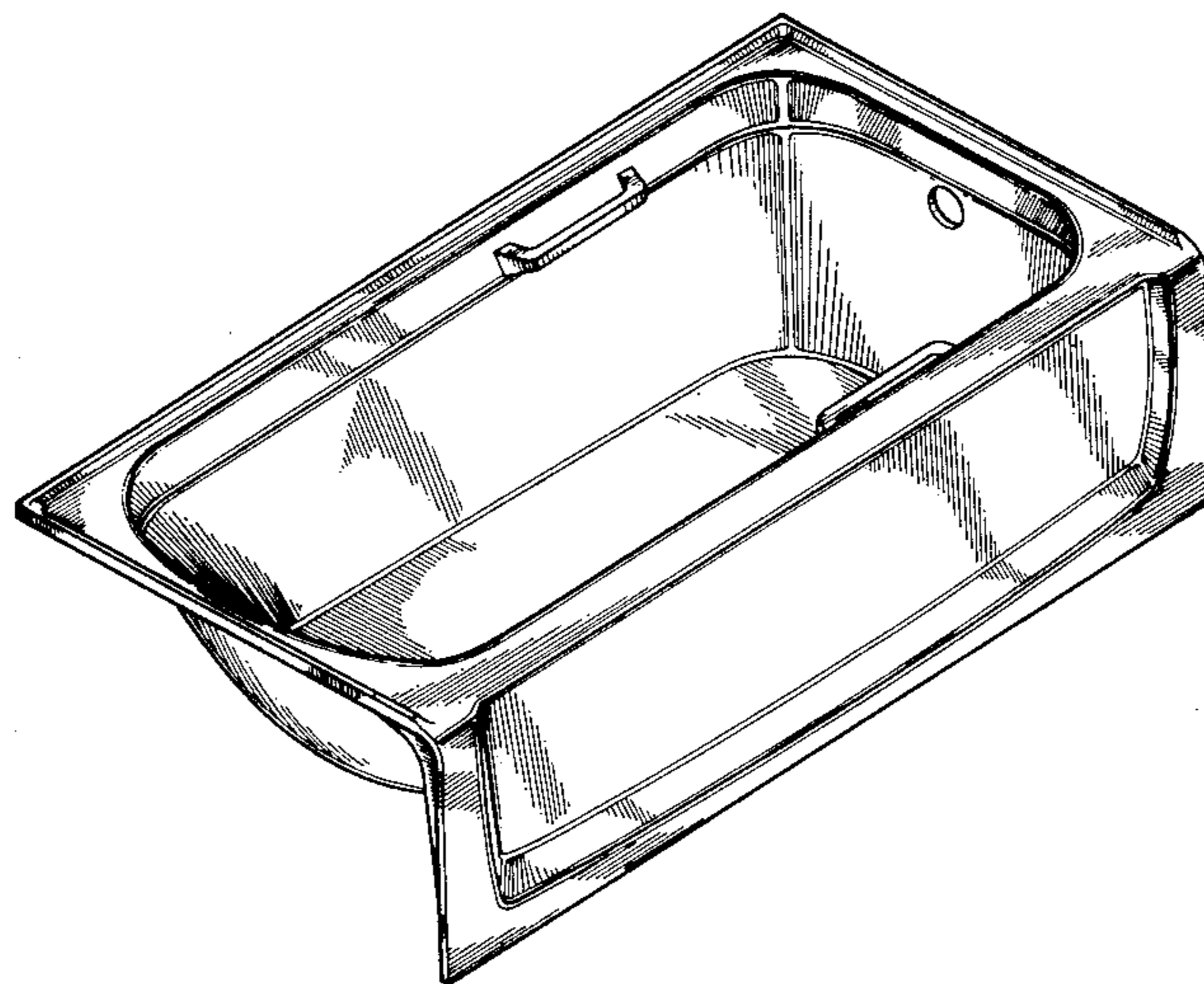

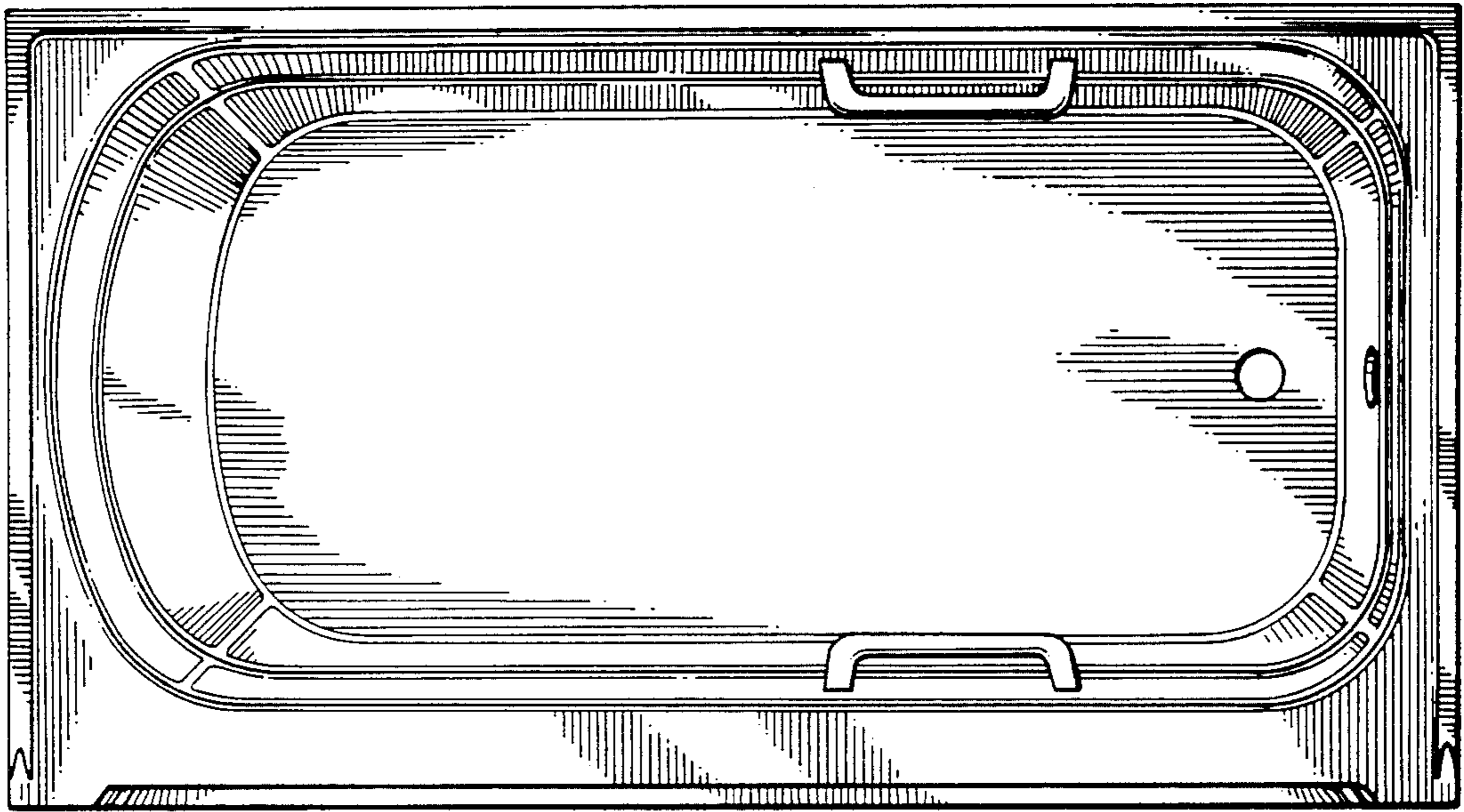

FIG. 1

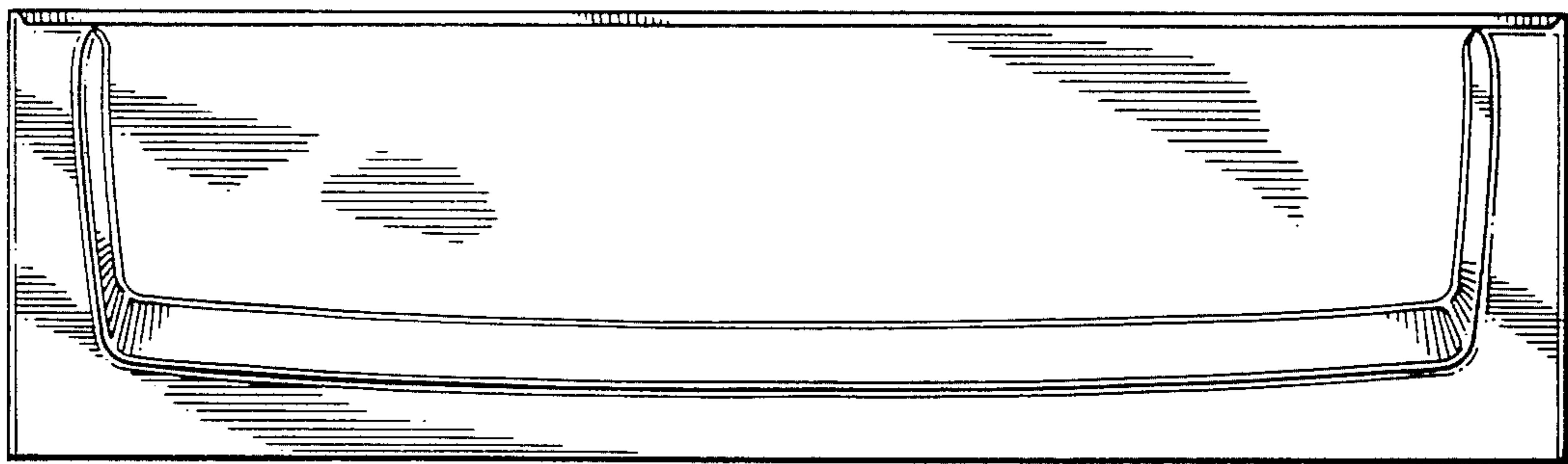

FIG. 2

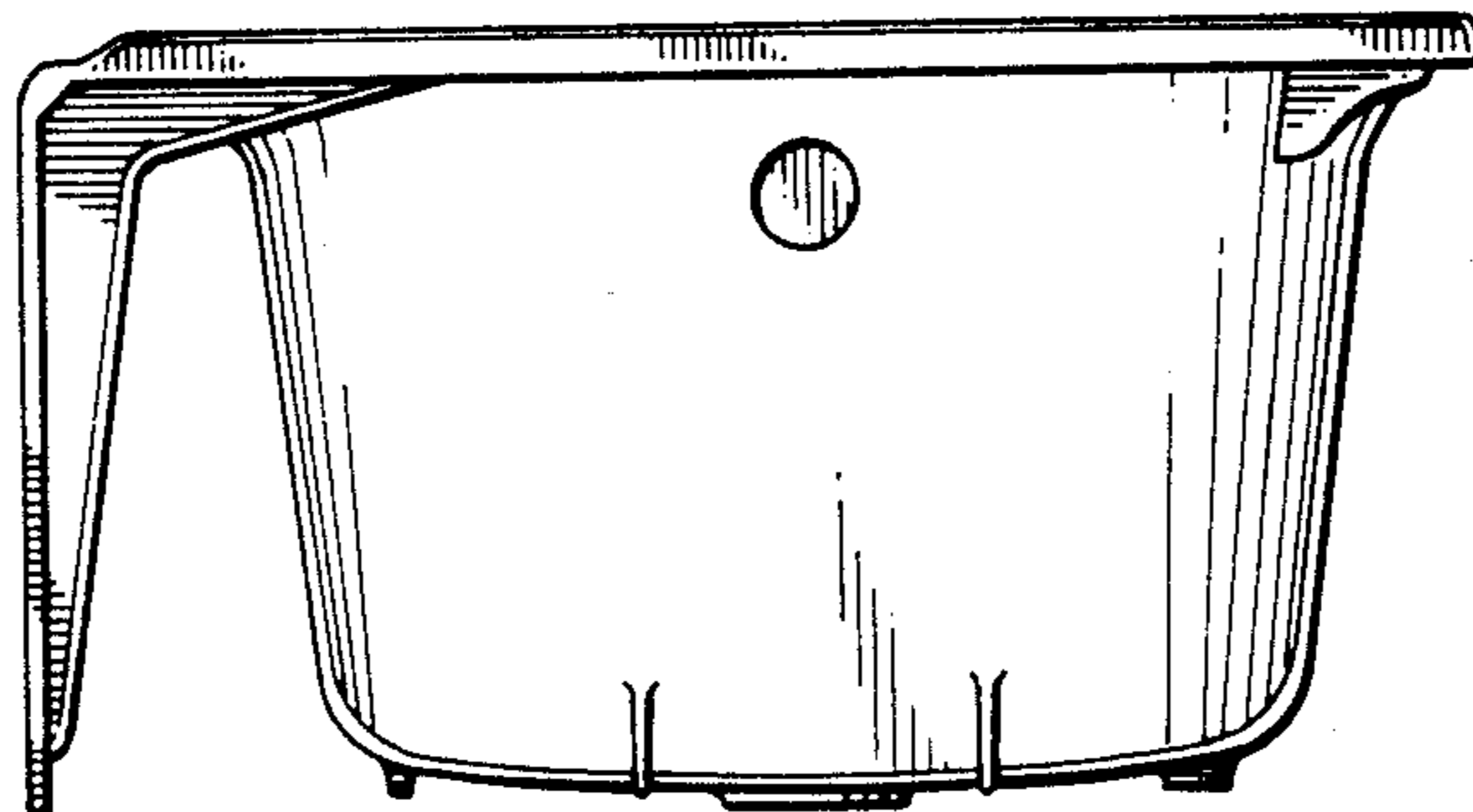

FIG. 3

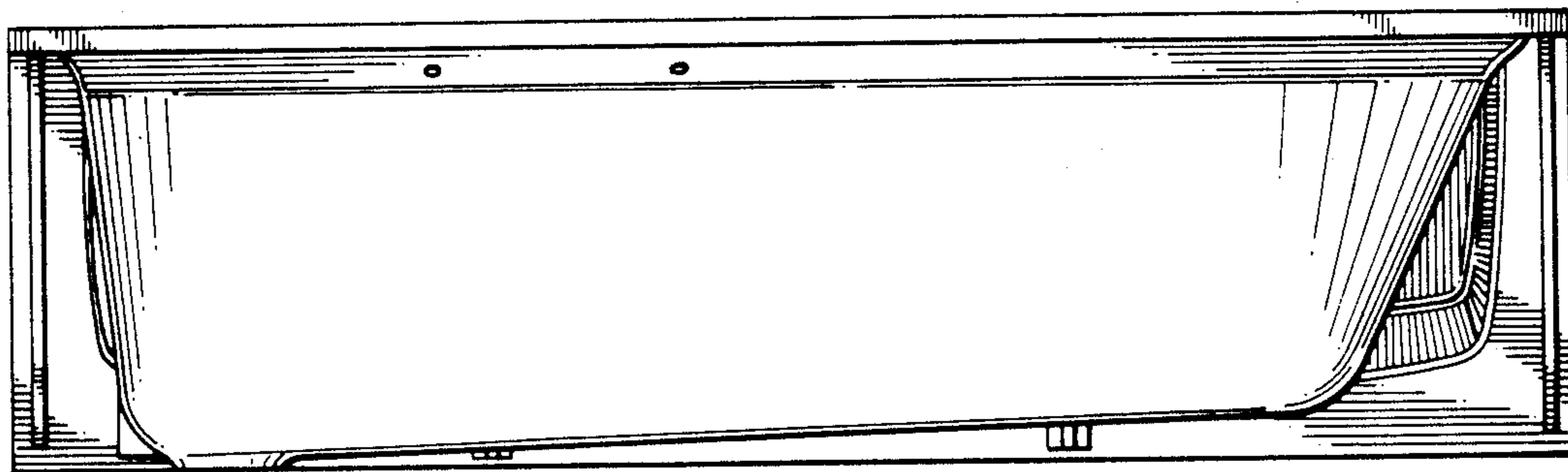

FIG. 4

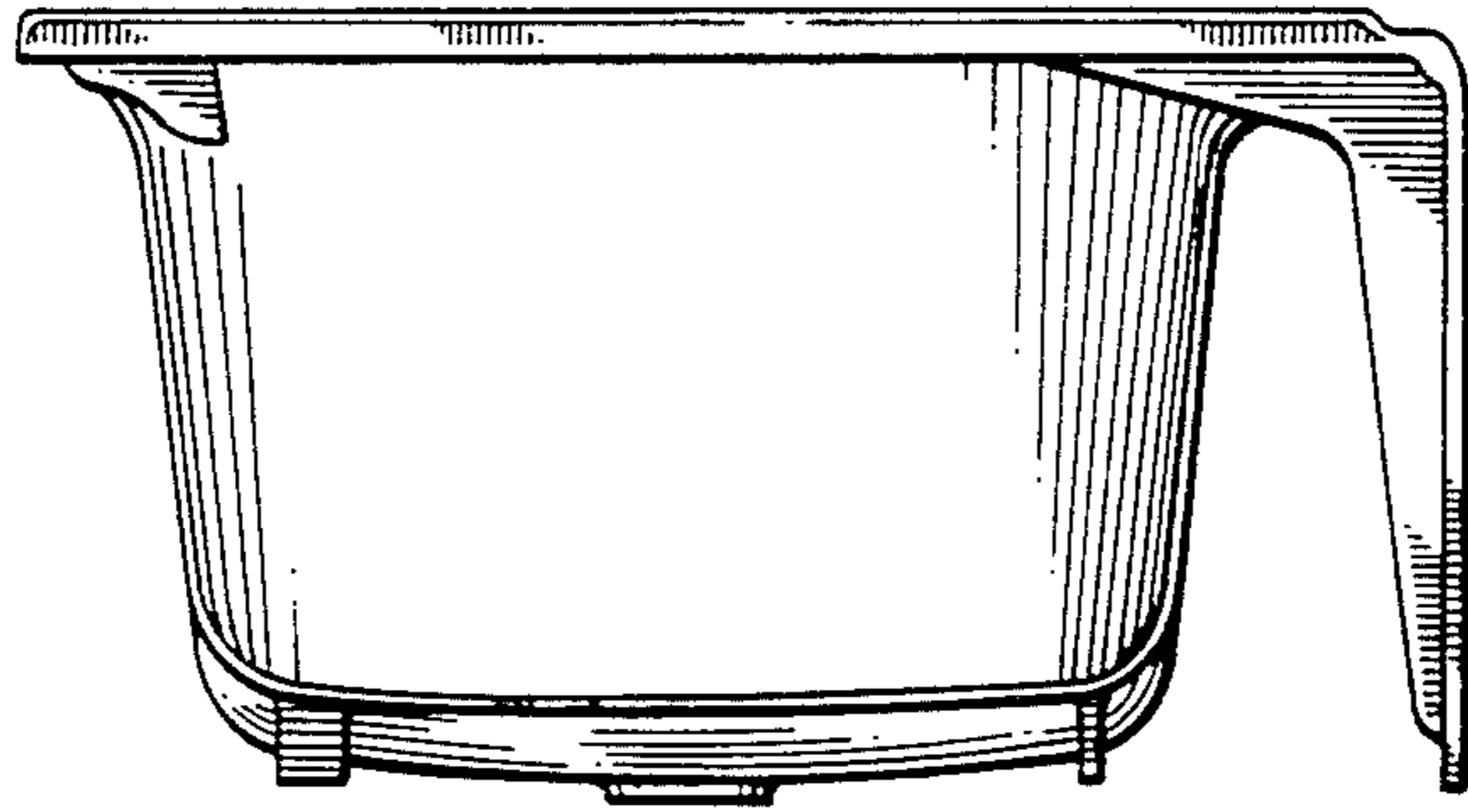

FIG. 5

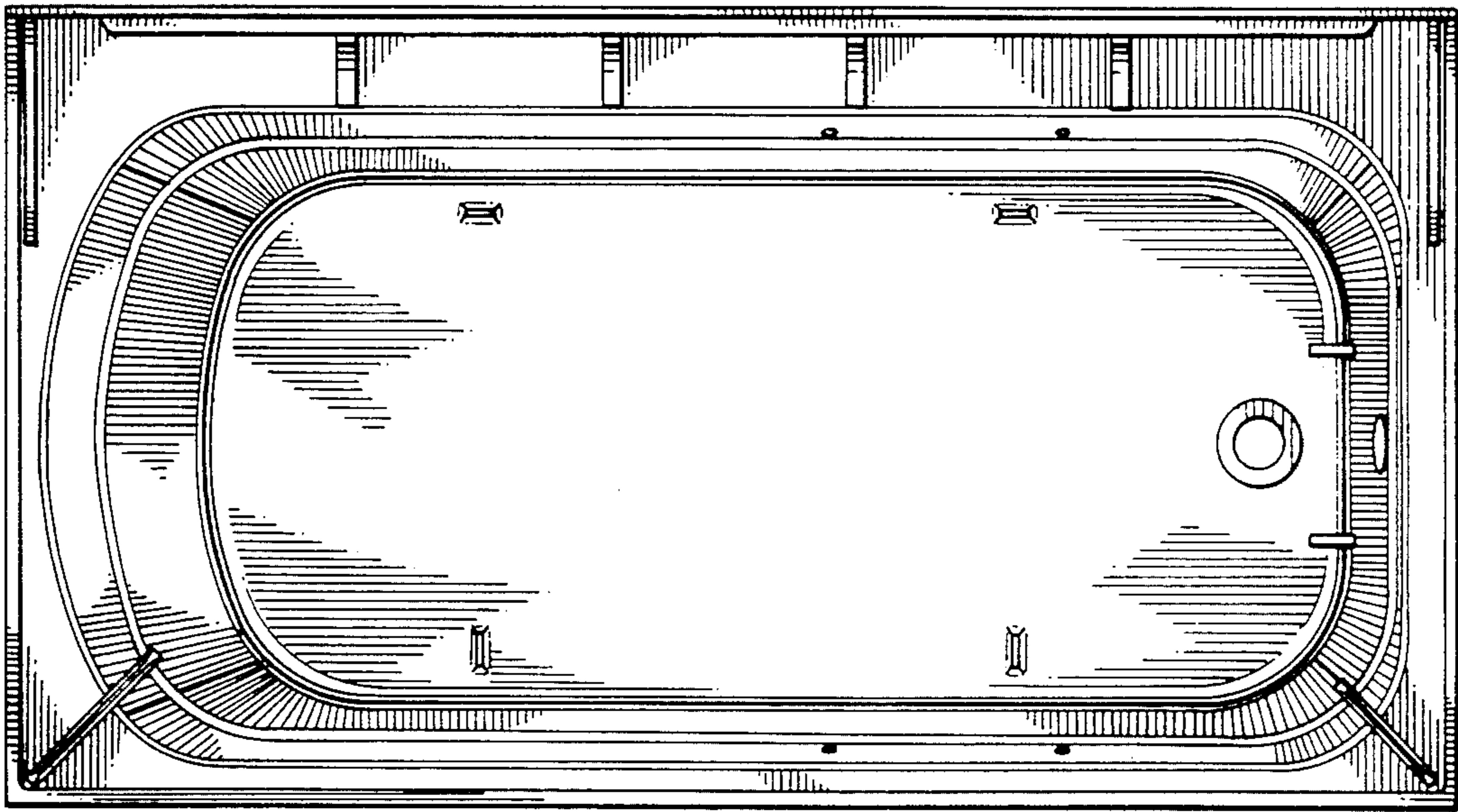

FIG. 6

