

[54] ELECTRONIC COPYING MACHINE

[75] Inventors: Kunio Hara, Chiba; Shigeru Sutoh, Urawa; Hideyuki Horie, Kamagaya; Tooru Okuyama, Isehara; Shinichi Hiroki, Tokyo, all of Japan

[73] Assignee: Tokyo Shibaura Denki Kabushiki Kaisha, Japan

[**] Term: 14 Years

[21] Appl. No.: 552,828

[22] Filed: Nov. 17, 1983

[30] Foreign Application Priority Data

May 18, 1983 [JP] Japan 58-20643

[52] U.S. Cl. D16/31

[58] Field of Search 355/3 R, 3 SH, 4-5, 355/8-11, 14 R, 14 SH, 35 H, 51; D16/27-32

[56] References Cited

U.S. PATENT DOCUMENTS

- D. 245,612 8/1977 Zeuthen D16/31
- D. 246,526 11/1977 Kurozumi D16/31
- D. 264,345 5/1982 Masaki D16/31
- D. 264,727 6/1982 Matsuzaka D16/31

- D. 265,656 8/1982 Matsushima D16/31
- D. 270,164 8/1983 Sawada D16/31
- D. 270,452 9/1983 Sakuai D16/31
- D. 278,152 3/1985 Hara D16/31

OTHER PUBLICATIONS

Ricoh FT4700 (Flier)-1/81/Copier at top-right of rear side.

Primary Examiner—Nelson C. Holtje
Attorney, Agent, or Firm—Finnegan, Henderson, Farabow, Garrett & Dunner

[57] CLAIM

The ornamental design for an electronic copying machine, substantially as shown.

DESCRIPTION

FIG. 1 is a front, top, and right side perspective view of an electronic copying machine showing our new design; FIG. 2 is a front elevational view thereof; FIG. 3 is a left side elevational view thereof; FIG. 4 is a right side elevational view thereof; FIG. 5 is a top plan view thereof; FIG. 6 is a rear elevational view thereof; and FIG. 7 is a perspective view of FIG. 1 with the cover in the open position.

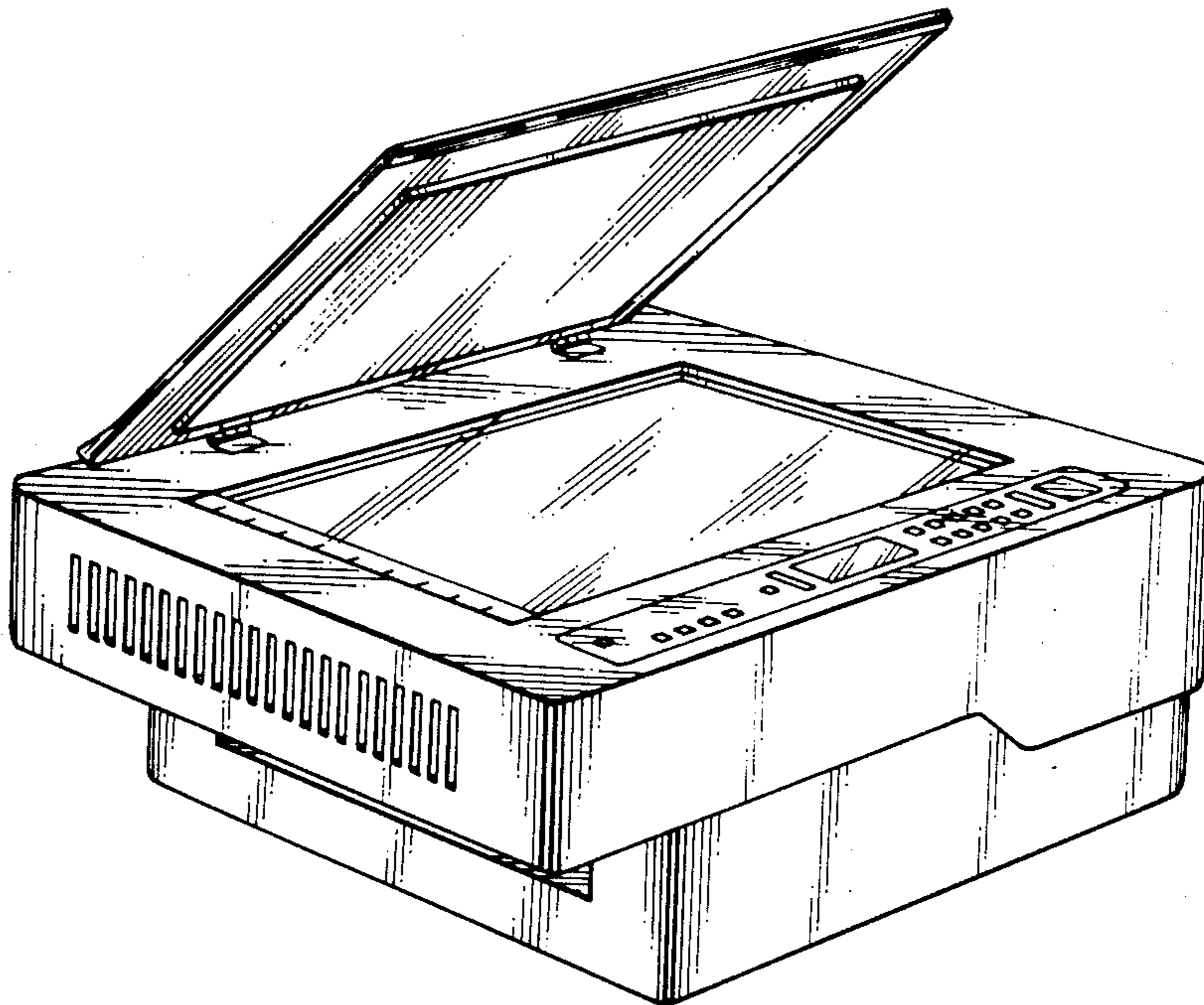

FIG. 1

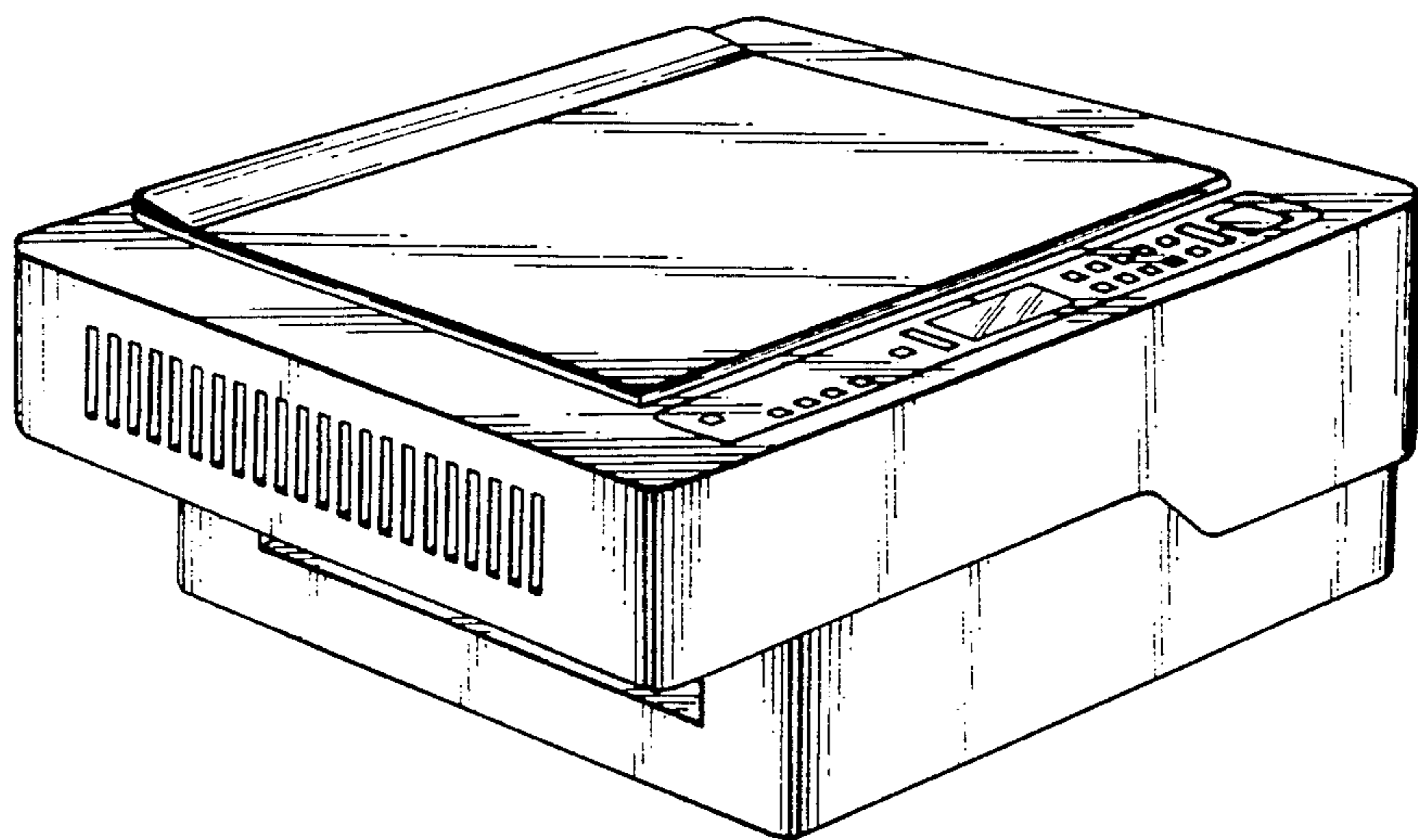

FIG. 2

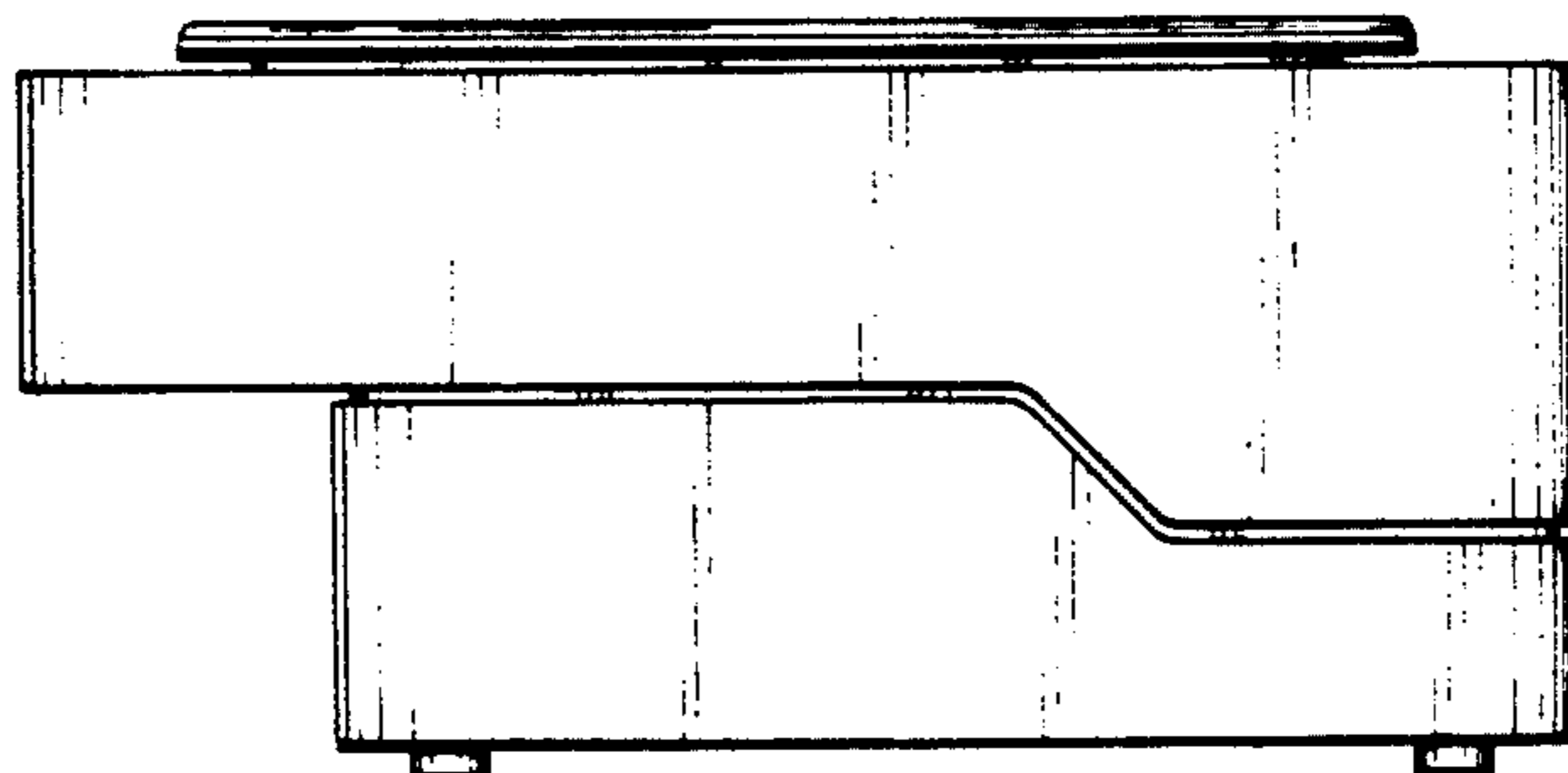

FIG. 3

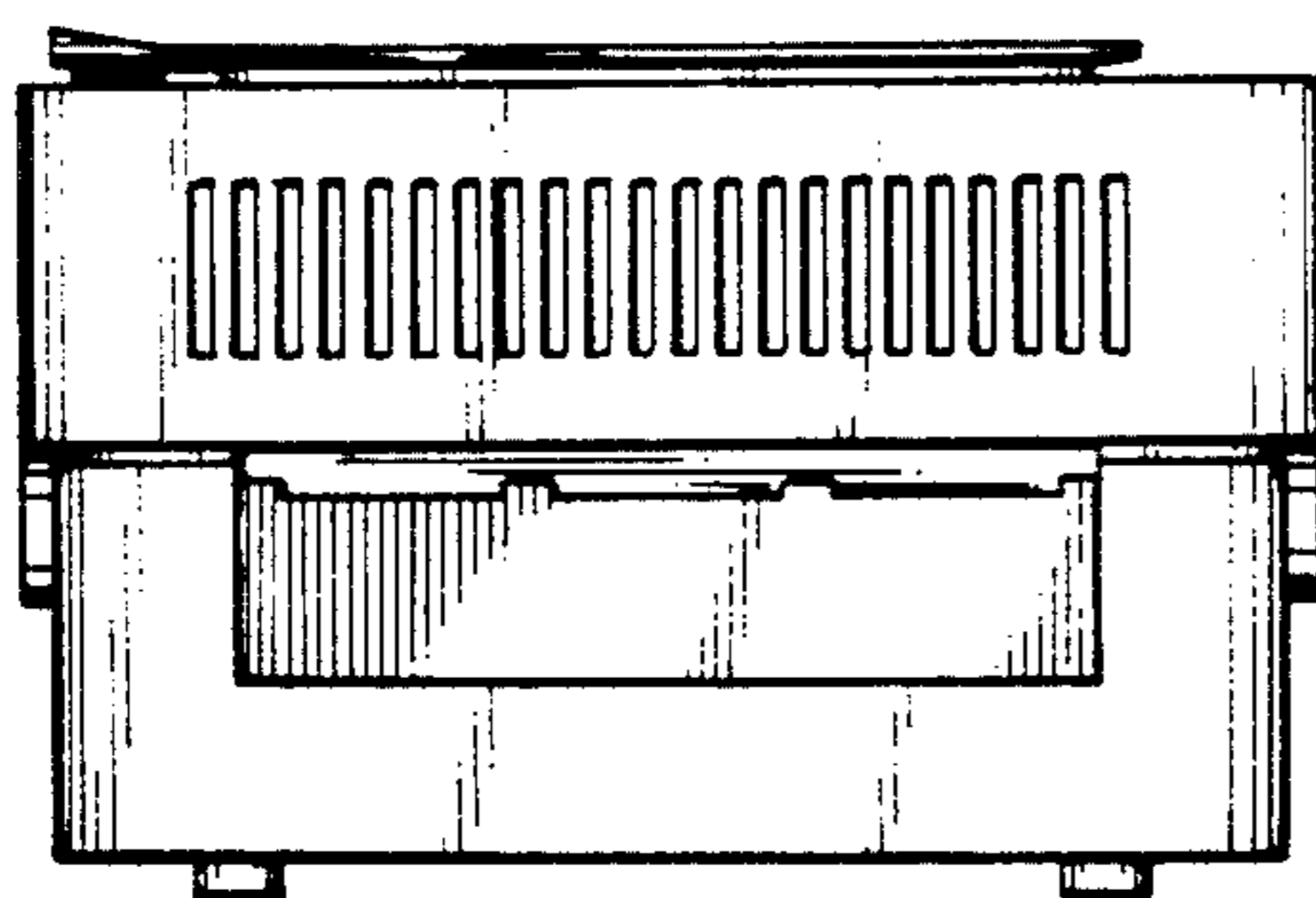

FIG. 4

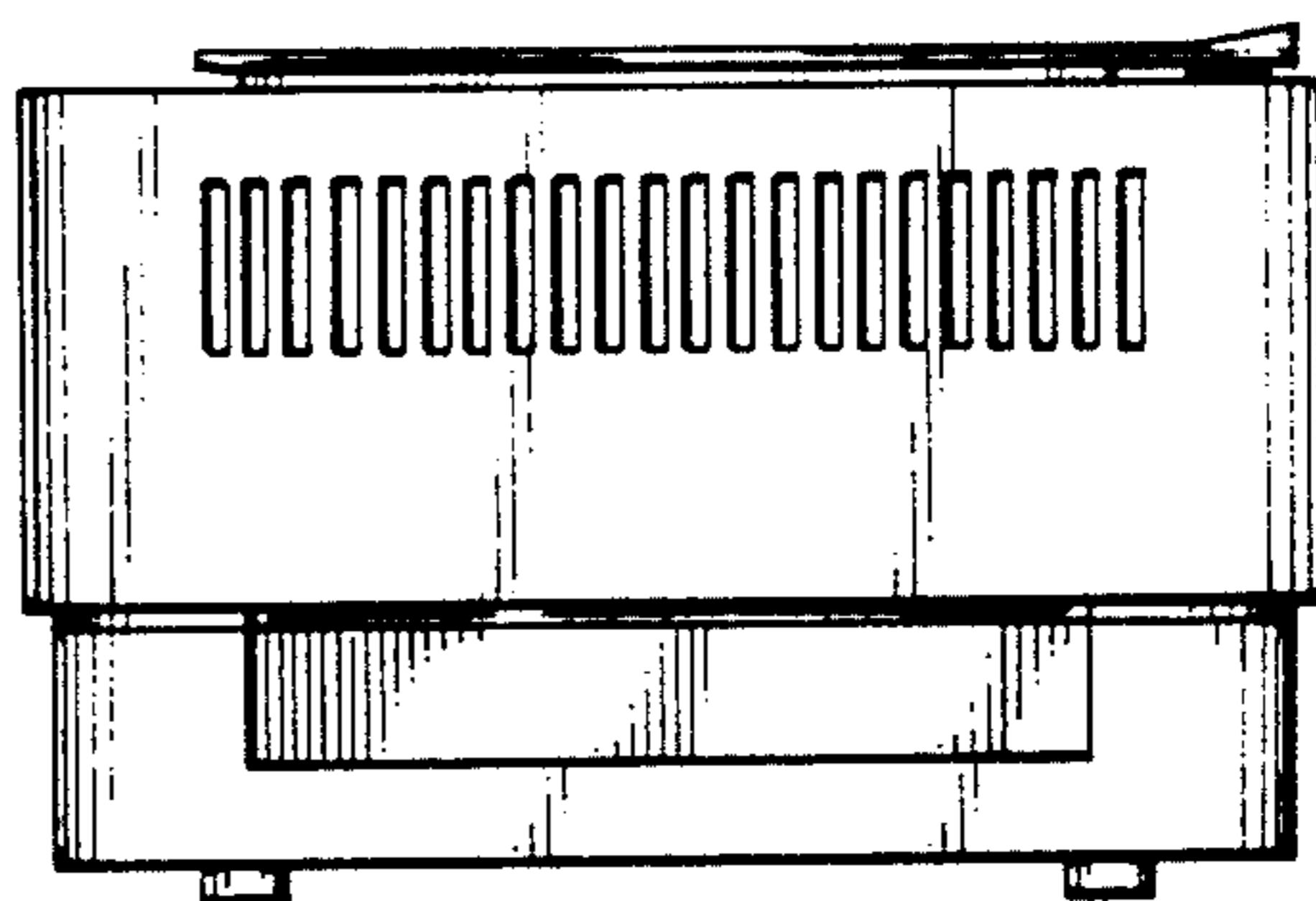

FIG. 5

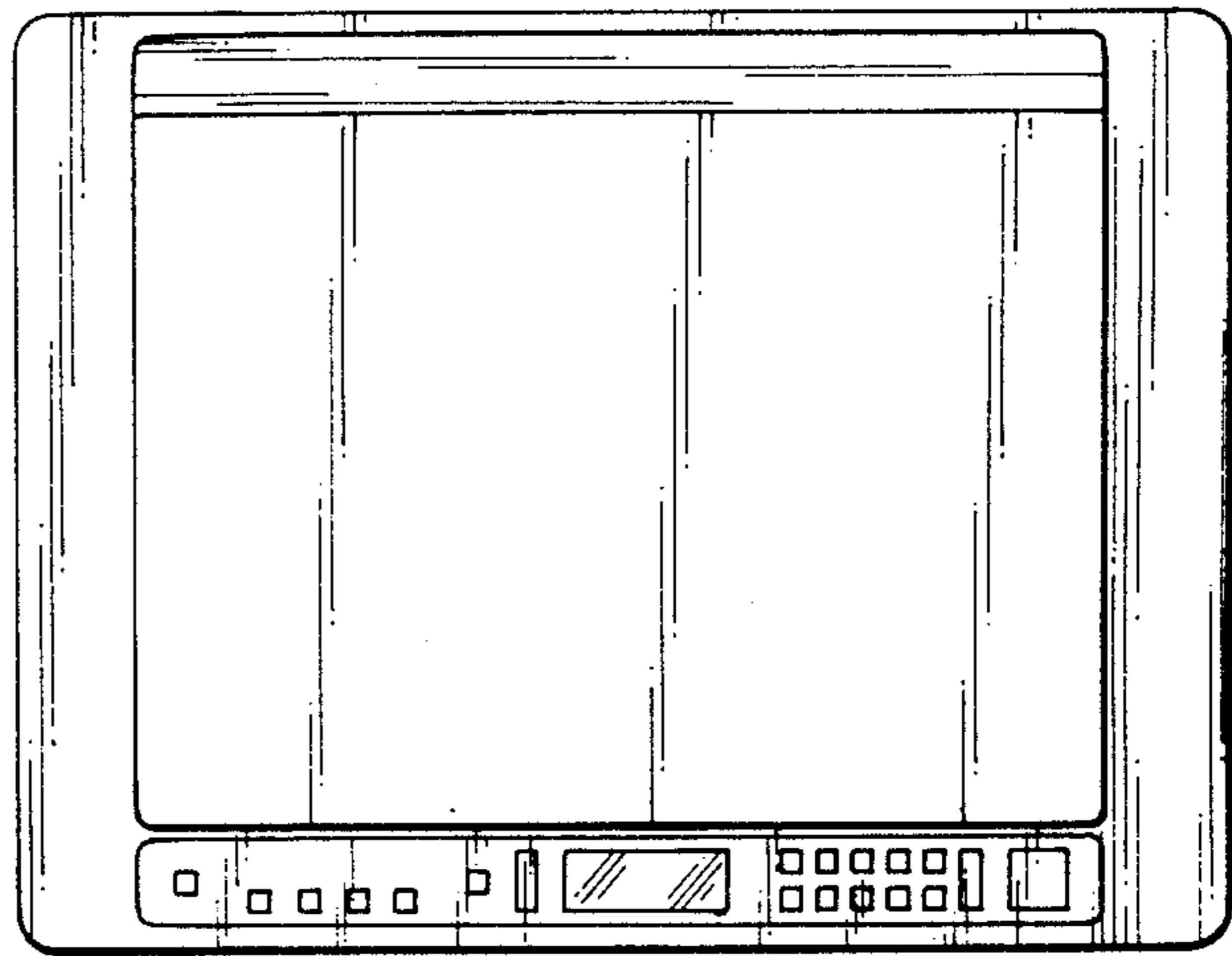

FIG. 6

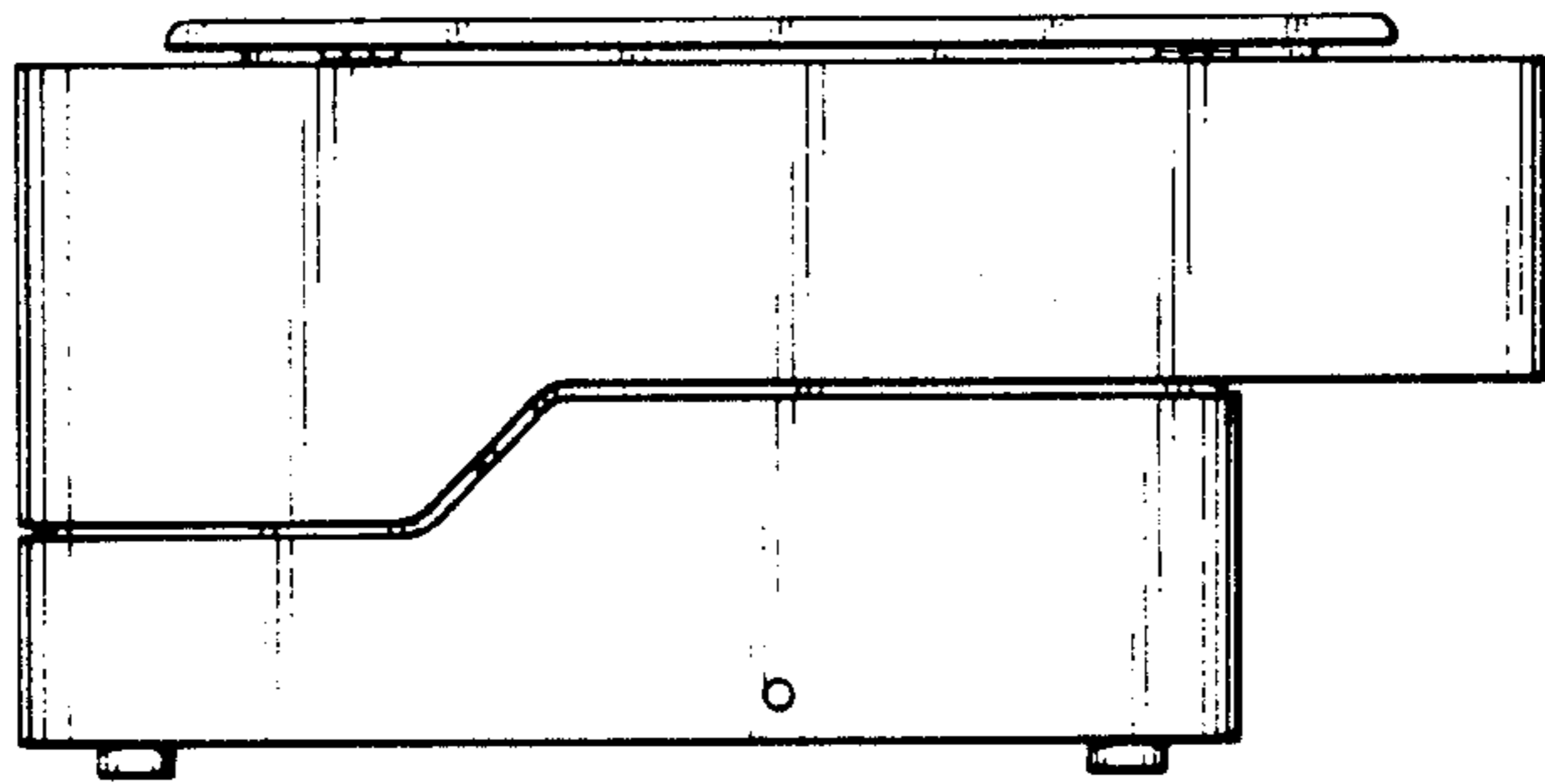

FIG. 7

