

[54] **COMMODE CHAIR**

[76] Inventors: **Bob S. Shigenaka**, 181 Tally Ho Rd.;
John S. Figueiredo, P.O. Box Drawer
0, both of Arroyo Grande, Calif.
93420

3,061,368	10/1962	Matthews	4/480 X
3,360,297	12/1967	Oja et al.	4/480 X
4,028,749	6/1977	James	4/480
4,155,126	5/1979	Classen	4/661
4,229,039	10/1980	Day	4/480
4,266,305	5/1981	Kavaloski et al.	4/480
4,334,330	6/1982	Marshall	4/480

[**] Term: **14 Years**

Primary Examiner—James R. Largen
Attorney, Agent, or Firm—John H. Crowe

[21] Appl. No.: **490,520**

[22] Filed: **May 2, 1983**

[57] **CLAIM**

[52] U.S. Cl. **D23/48**

The ornamental design for a commode chair, substantially as shown and described.

[58] Field of Search **D23/48; 4/480**

[56] **References Cited**

DESCRIPTION

U.S. PATENT DOCUMENTS

D. 234,769	4/1975	Thomas	D23/48
D. 236,345	8/1975	Thomas	D23/48
D. 260,583	9/1981	Brewer	D23/48 X
D. 264,618	5/1982	Hurley	D23/48
D. 265,119	6/1982	Hurley	D23/48
D. 276,931	12/1984	Bard	D23/48

FIG. 1 is a left side elevational view of a commode chair showing our new design.

FIG. 2 is a front elevational view thereof.

FIG. 3 is a right side elevational view thereof.

FIG. 4 is a rear elevational view thereof.

FIG. 5 is a top plan view thereof.

FIG. 6 is a bottom plan view thereof.

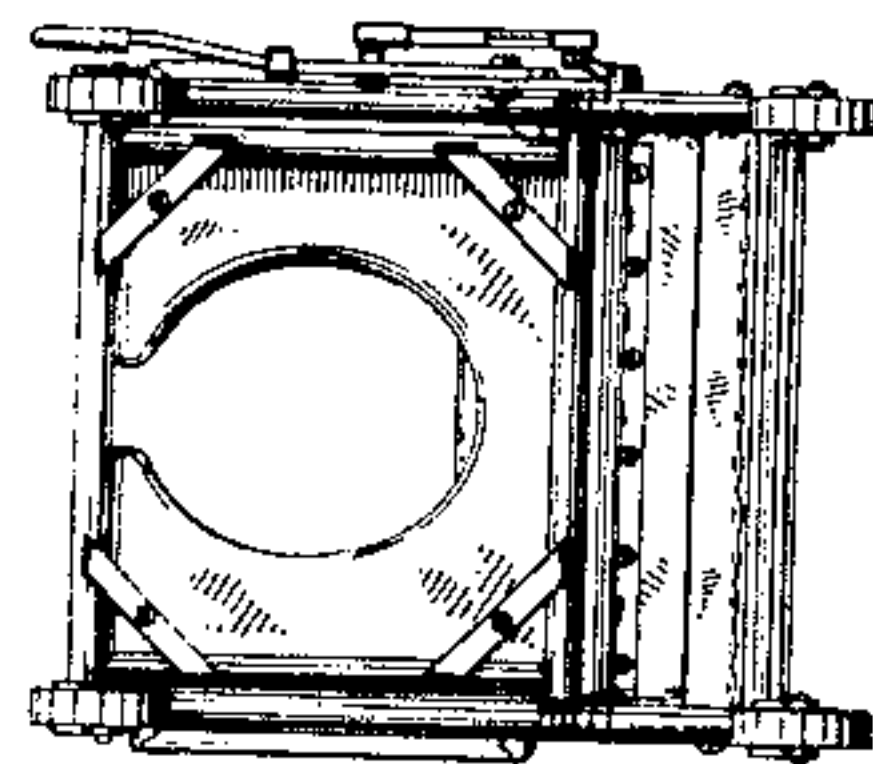
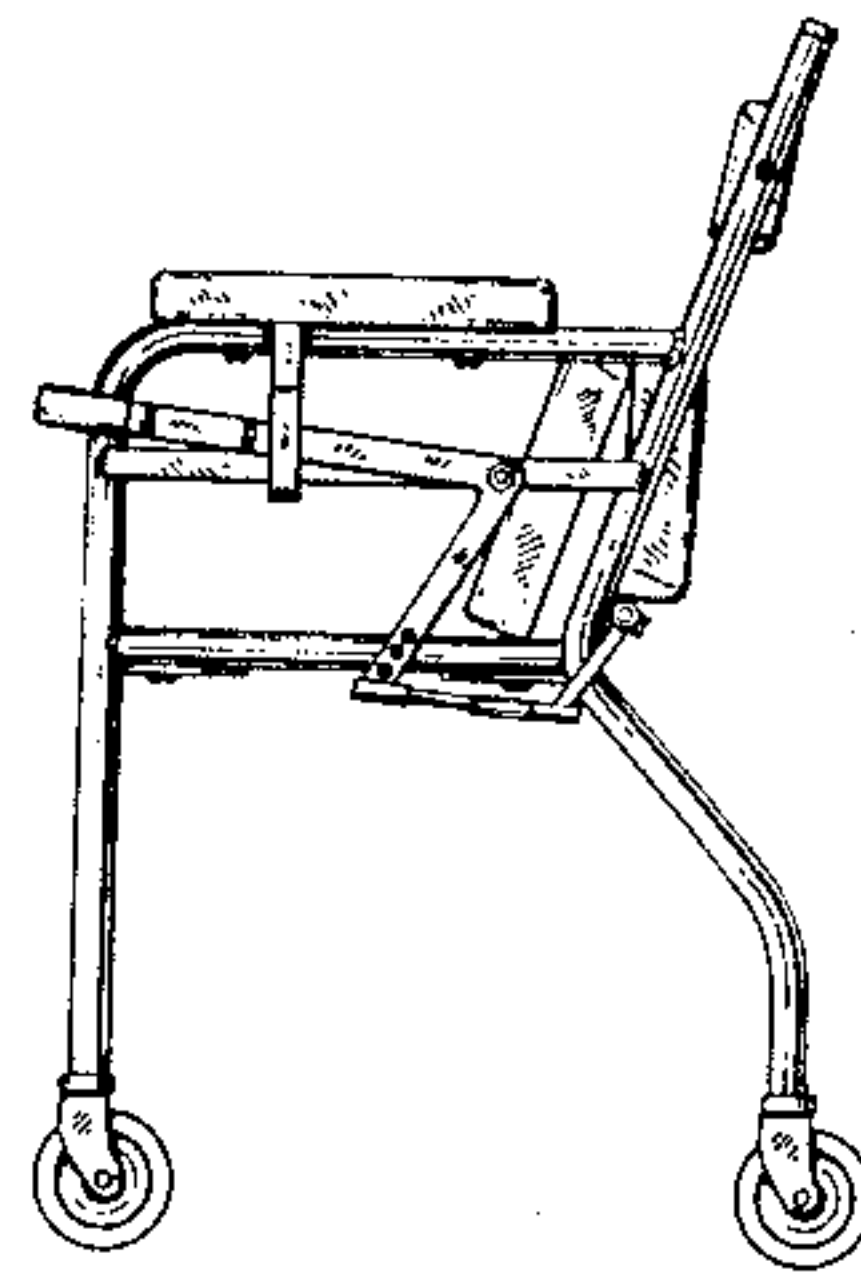

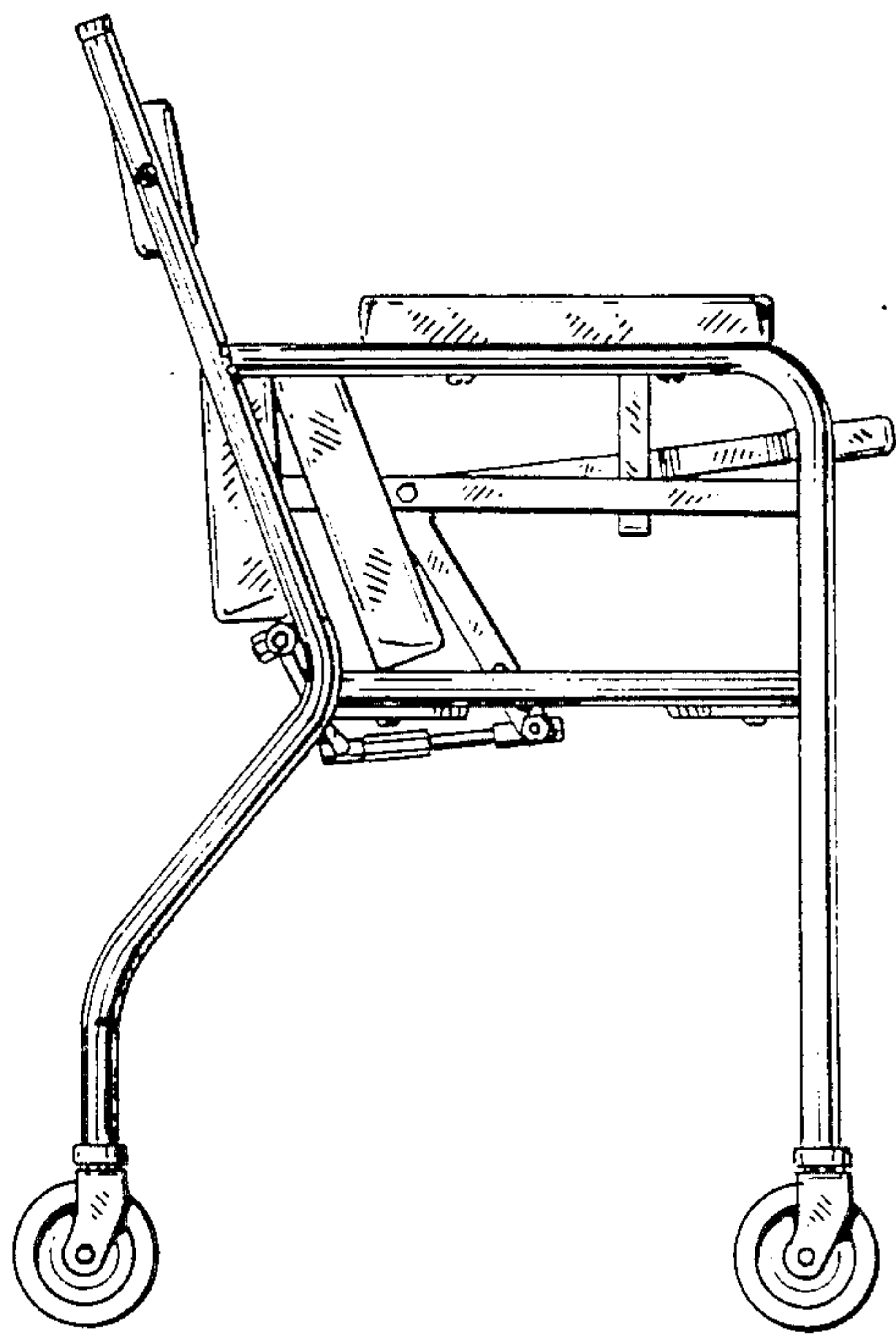

FIG. 1

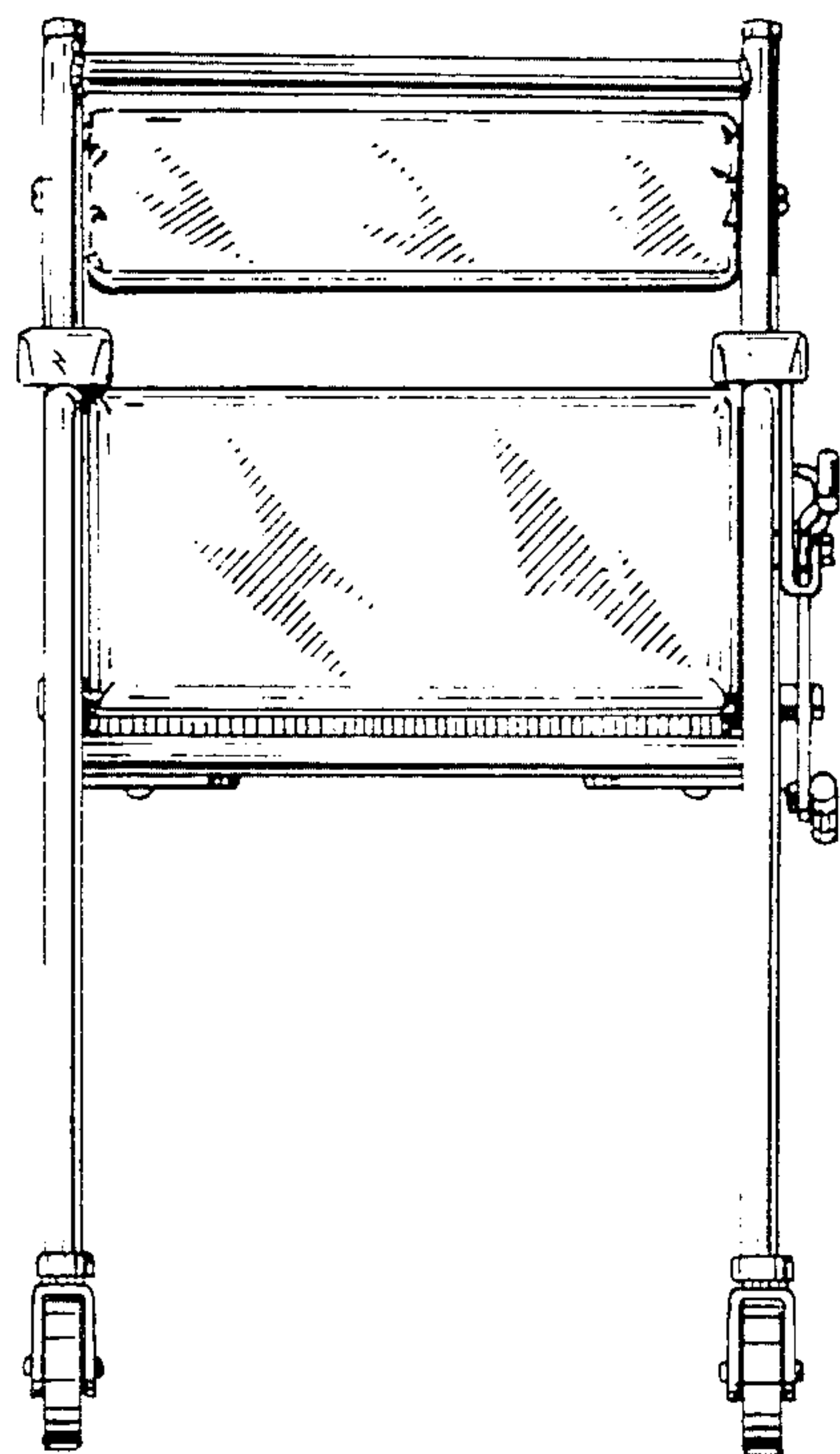

FIG. 2

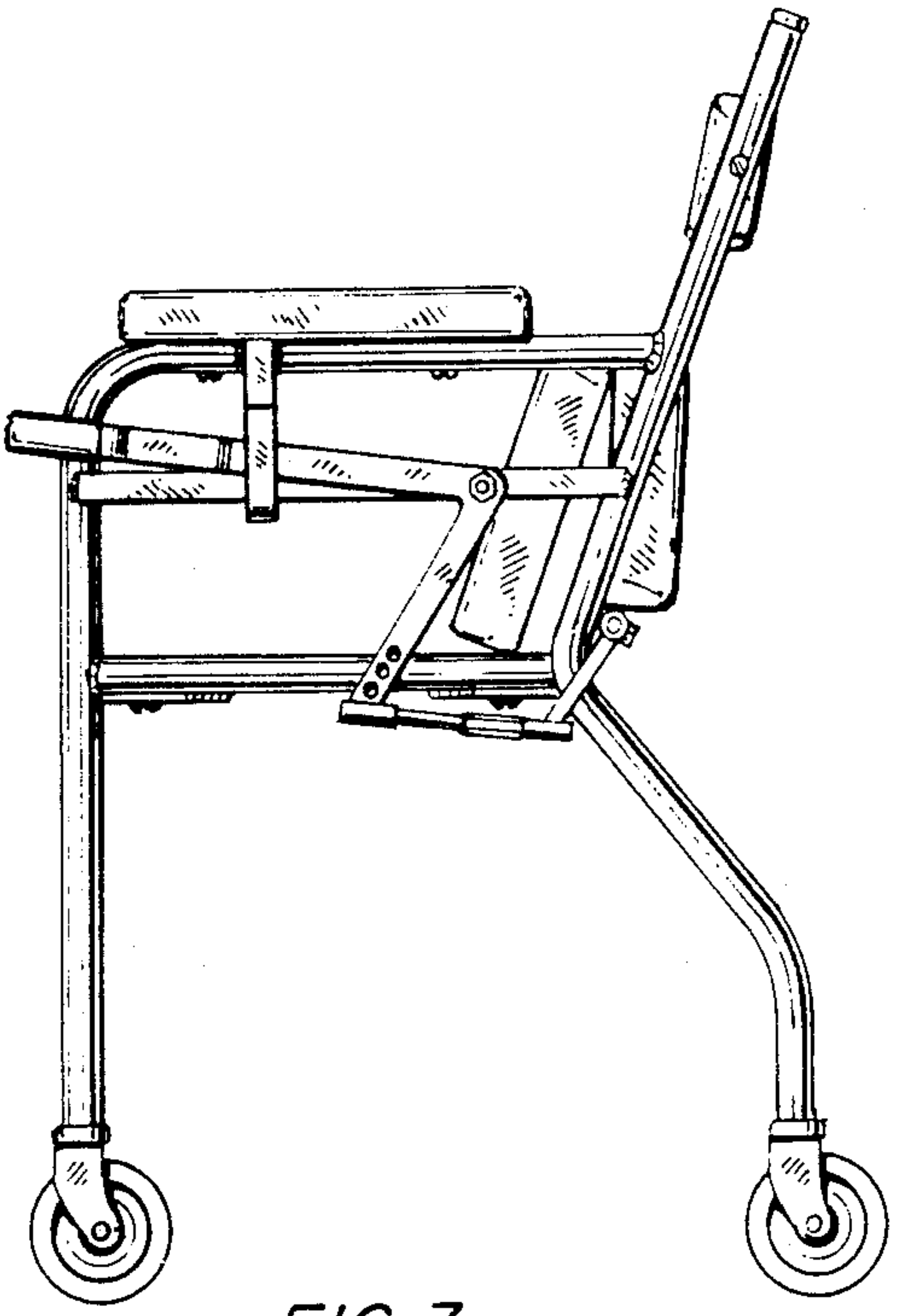

FIG. 3

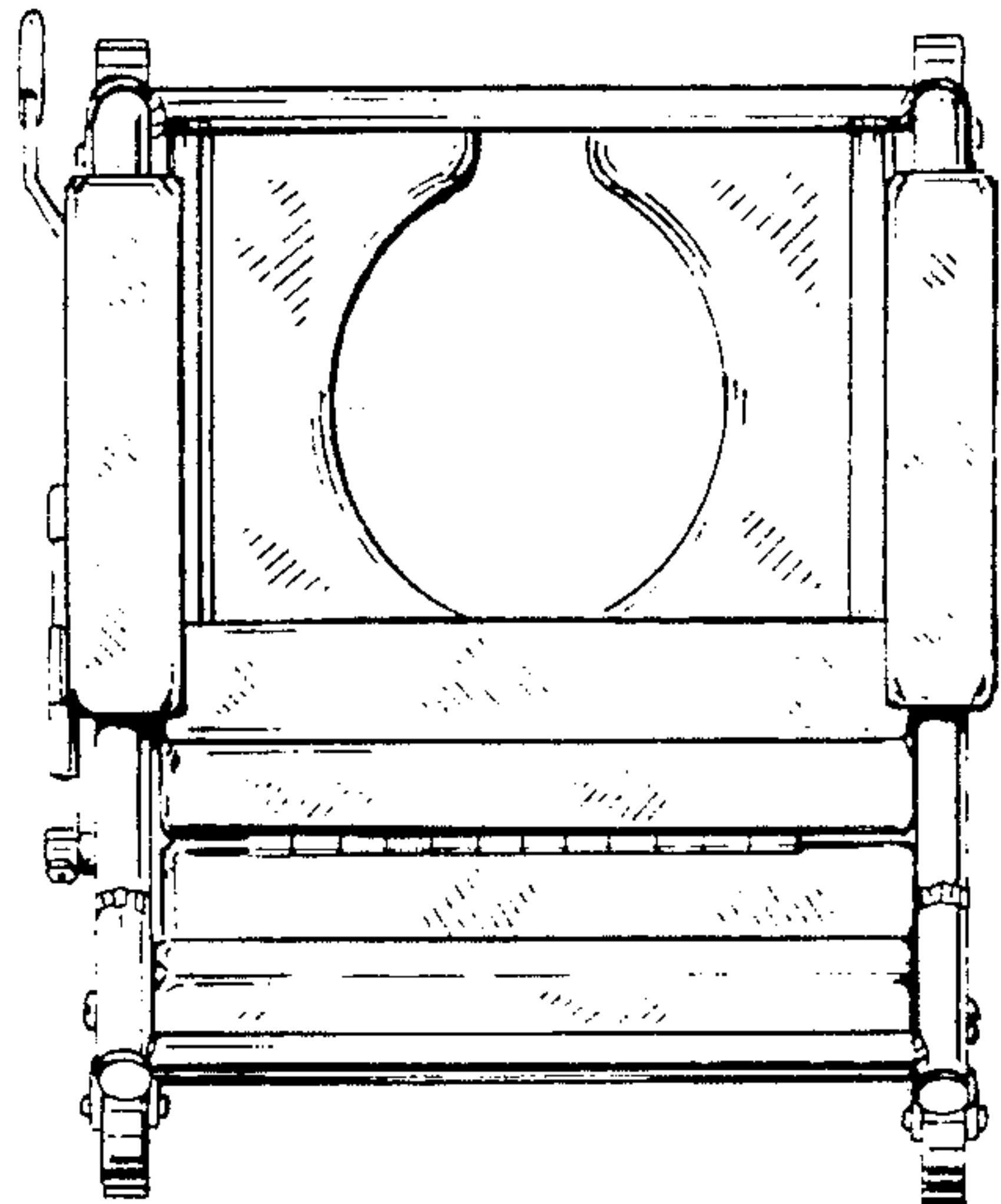

FIG. 5

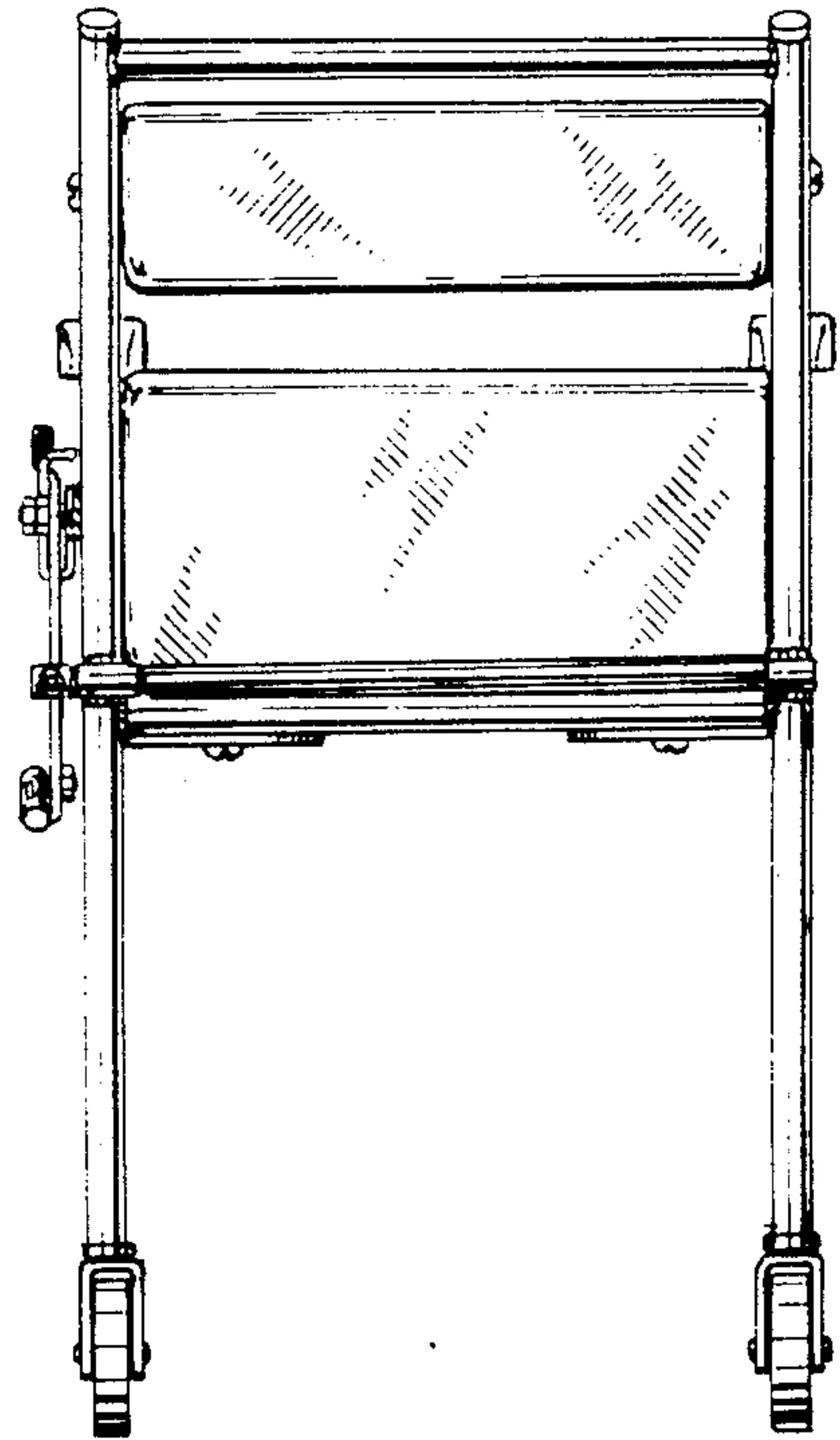

FIG. 4

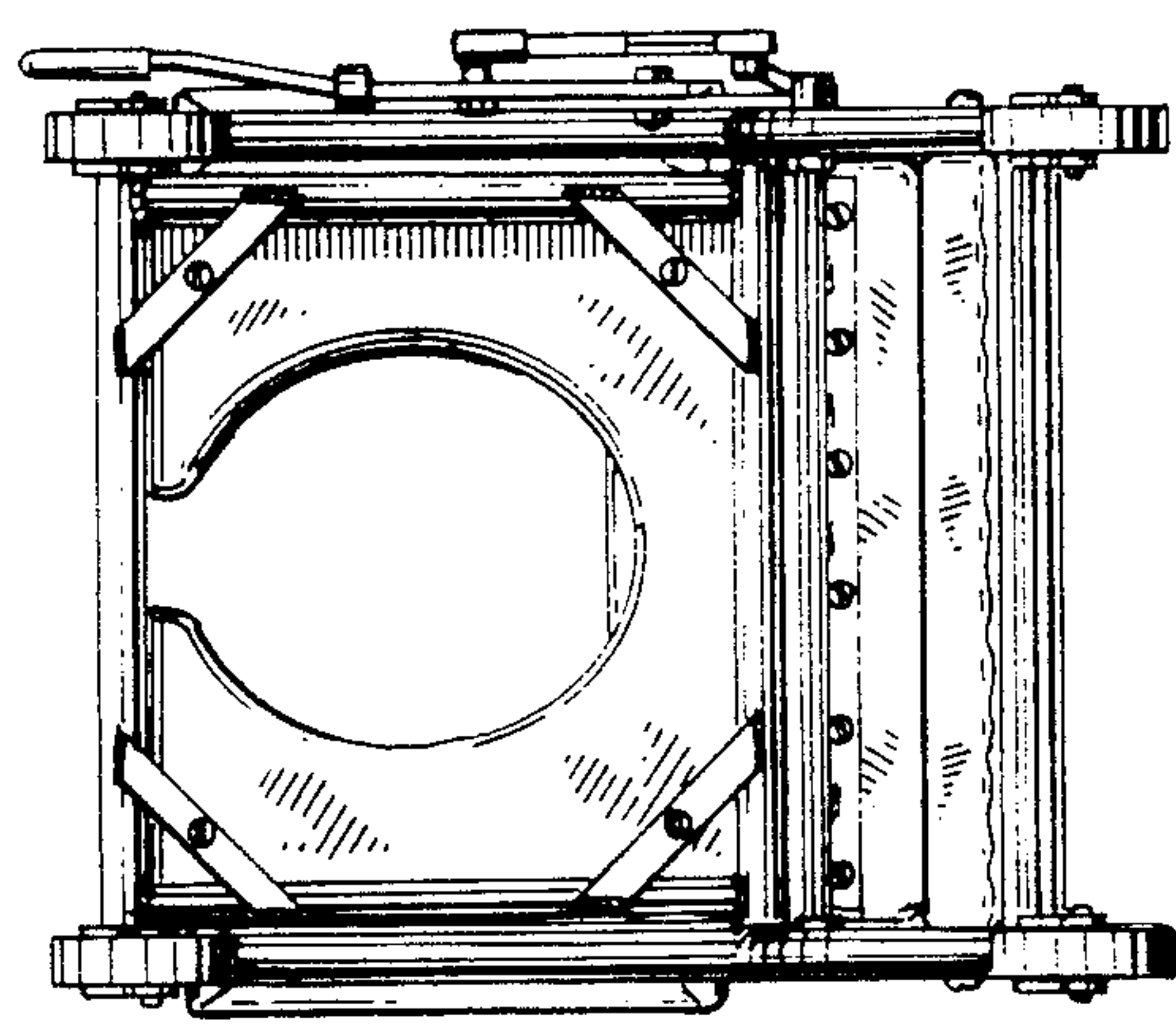

FIG. 6