

[54] COMPUTER DISPLAY

[75] Inventors: Kazuyuki Tsuburaya, Akikawa; Takanori Nishiyama, Koganei; Kazunori Yanagisawa, Higashiyamato, all of Japan

[73] Assignee: Hitachi, Ltd., Tokyo, Japan

[**] Term: 14 Years

[21] Appl. No.: 520,516

[22] Filed: Aug. 4, 1983

[30] Foreign Application Priority Data

Feb. 10, 1983 [JP] Japan 58-4862
Feb. 10, 1983 [JP] Japan 58-4864

[52] U.S. Cl. D14/113

[58] Field of Search D14/100, 106, 113;
D14/70, 81, 82, 83; 358/254, 249, 903; 340/700,
710, 711

[56] References Cited

U.S. PATENT DOCUMENTS

D. 271,874 12/1983 Endt D14/113
D. 274,726 7/1984 Caven D14/113
D. 276,236 11/1984 Akiyama D14/113
D. 279,007 5/1985 Empson et al. D14/113

OTHER PUBLICATIONS

Computer Design, 1-1982, p. 45, Daisy Systems Workstation Display.

Computer Design, 7-1982, p. 139, Visual Technology Inc., Display Terminal.

Design, 1-1981, p. 37, Nexos 2200 Display Terminal.

Primary Examiner—Susan J. Lucas

Attorney, Agent, or Firm—Antonelli, Terry & Wands

[57] CLAIM

The ornamental design for a computer display, as shown and described.

DESCRIPTION

FIG. 1 is a front, top and right side perspective view of a computer display showing our new design;

FIG. 2 is a front elevational view thereof;

FIG. 3 is a right side elevational view thereof;

FIG. 4 is a top plan view thereof;

FIG. 5 is a left side elevational view thereof;

FIG. 6 is a rear elevational view thereof;

FIG. 7 is a bottom plan view thereof;

FIG. 8 is a front, top and right side perspective view of a computer display showing another embodiment of our new design;

FIG. 9 is a front elevational view thereof;

FIG. 10 is a right side elevational view thereof;

FIG. 11 is a top plan view thereof;

FIG. 12 is a left side elevational view thereof;

FIG. 13 is a rear elevational view thereof; and

FIG. 14 is a bottom plan view thereof.

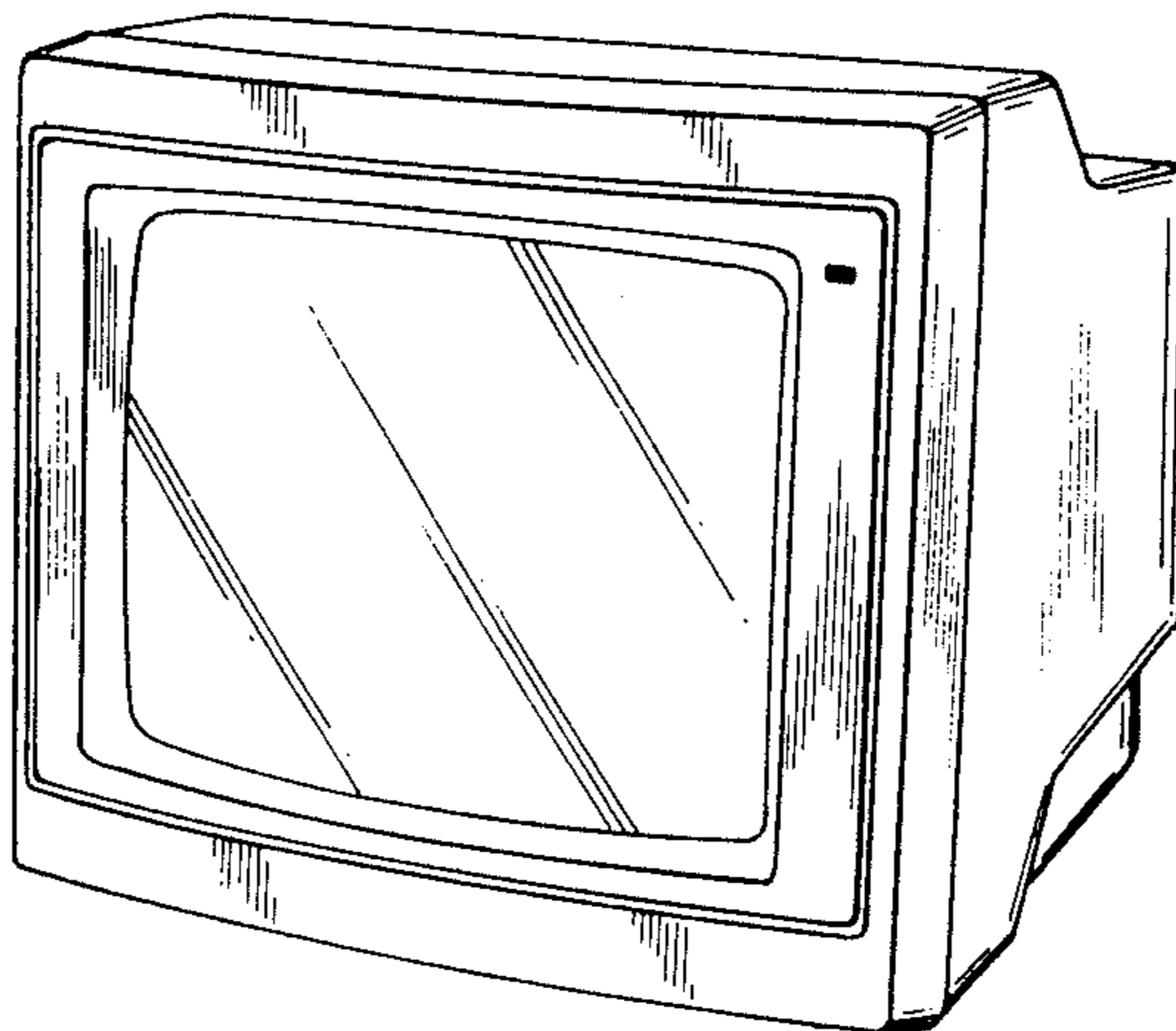

FIG. 1

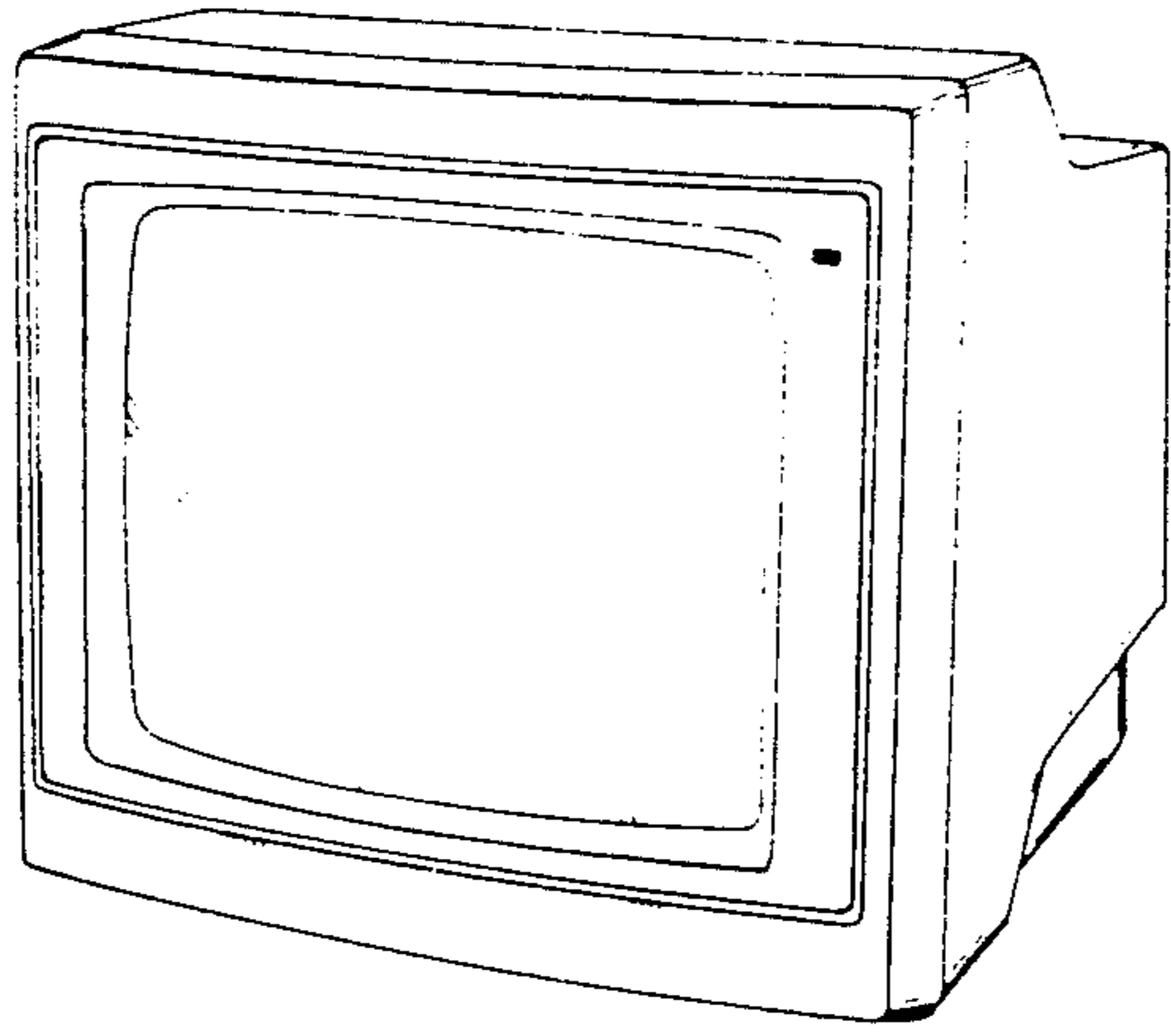

FIG. 2

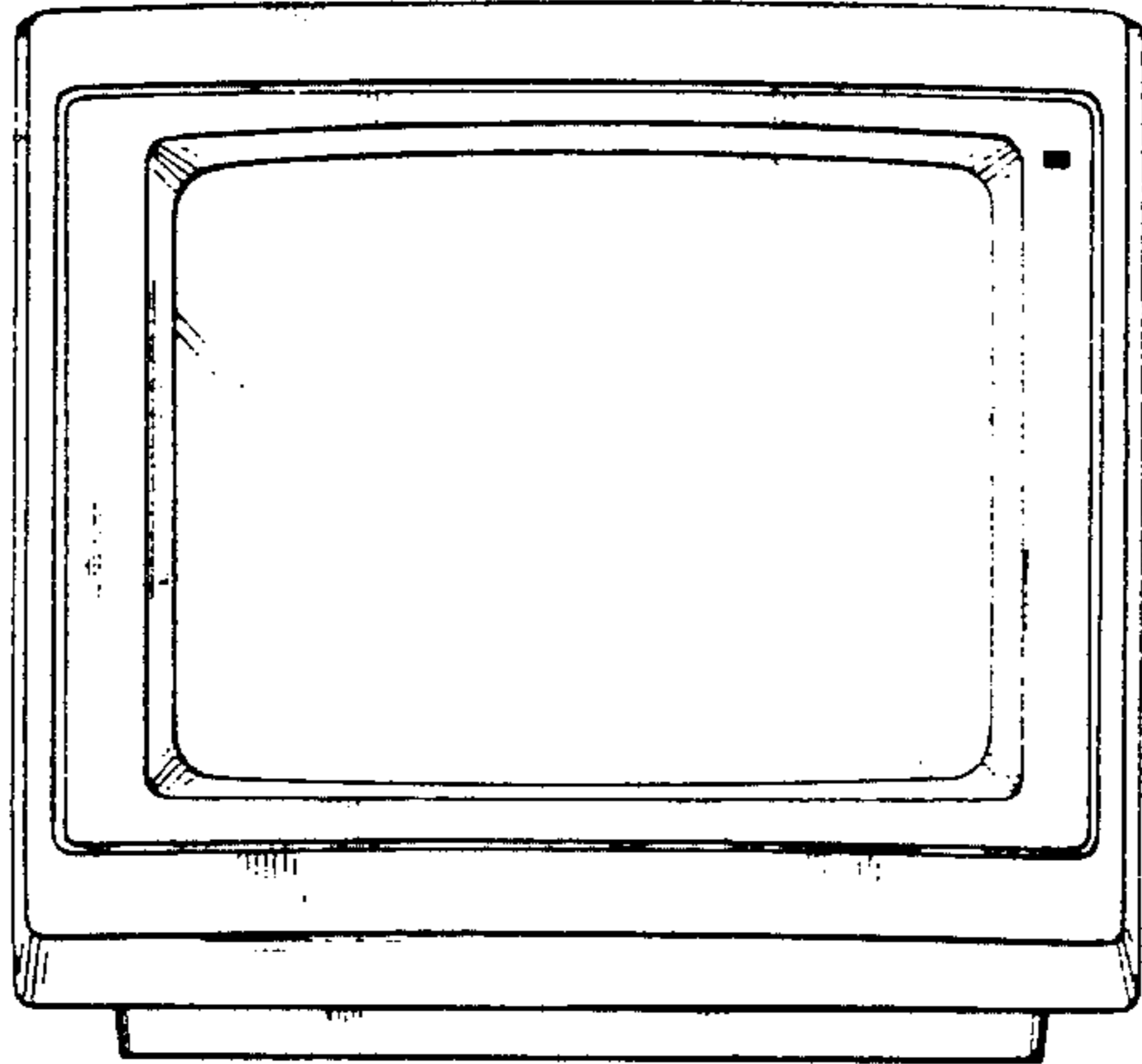

FIG. 3

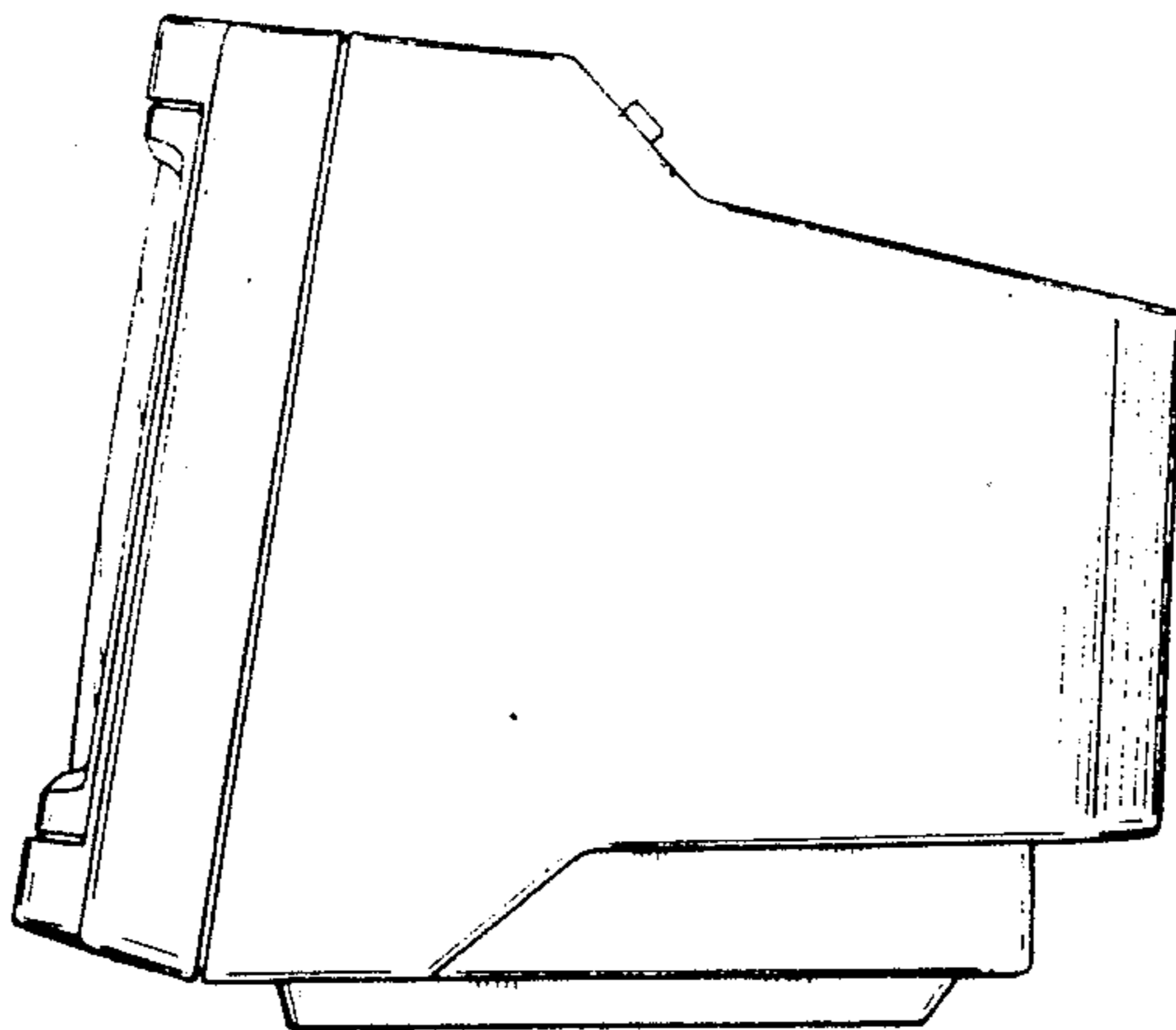

FIG. 4

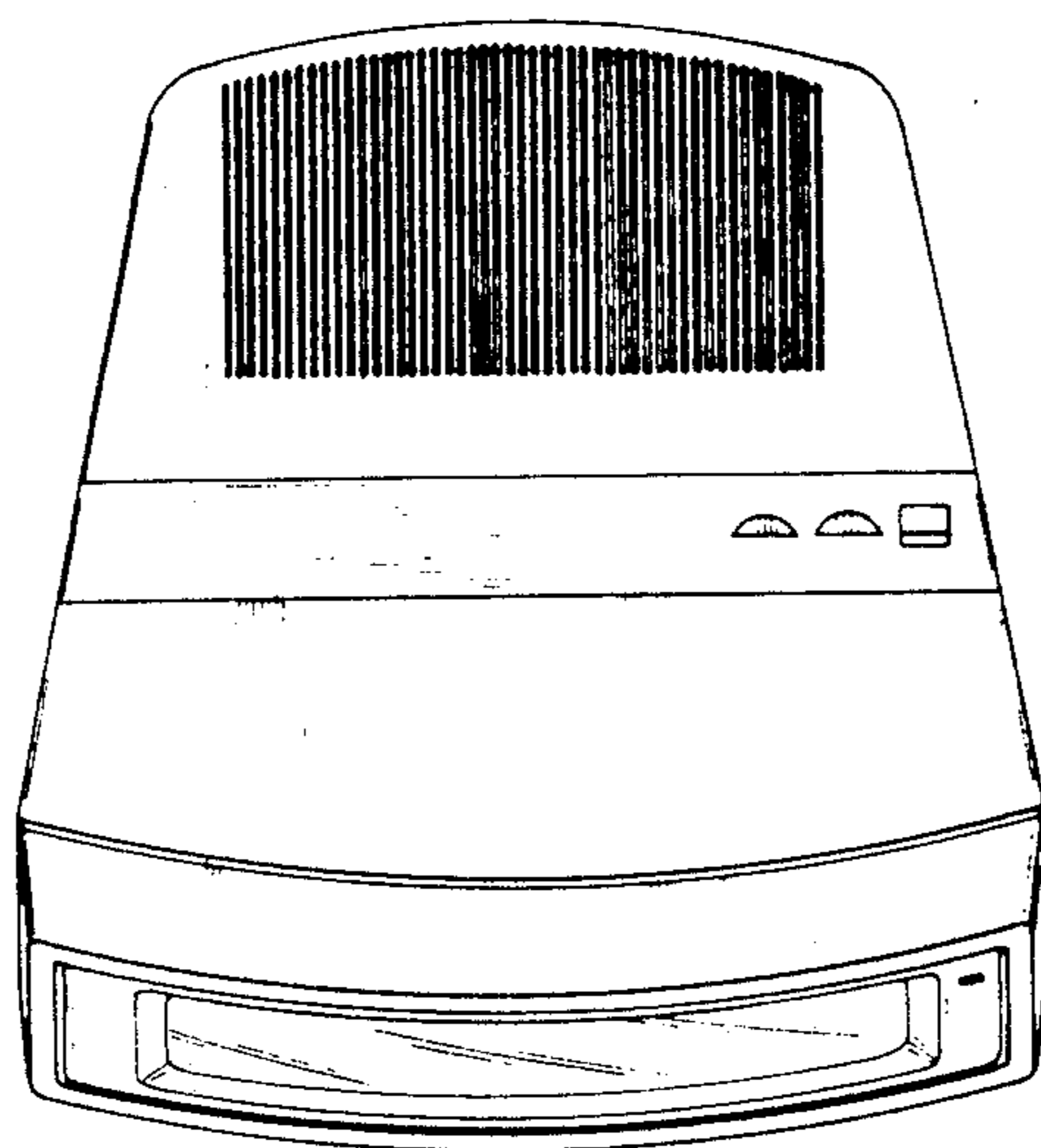

FIG. 5

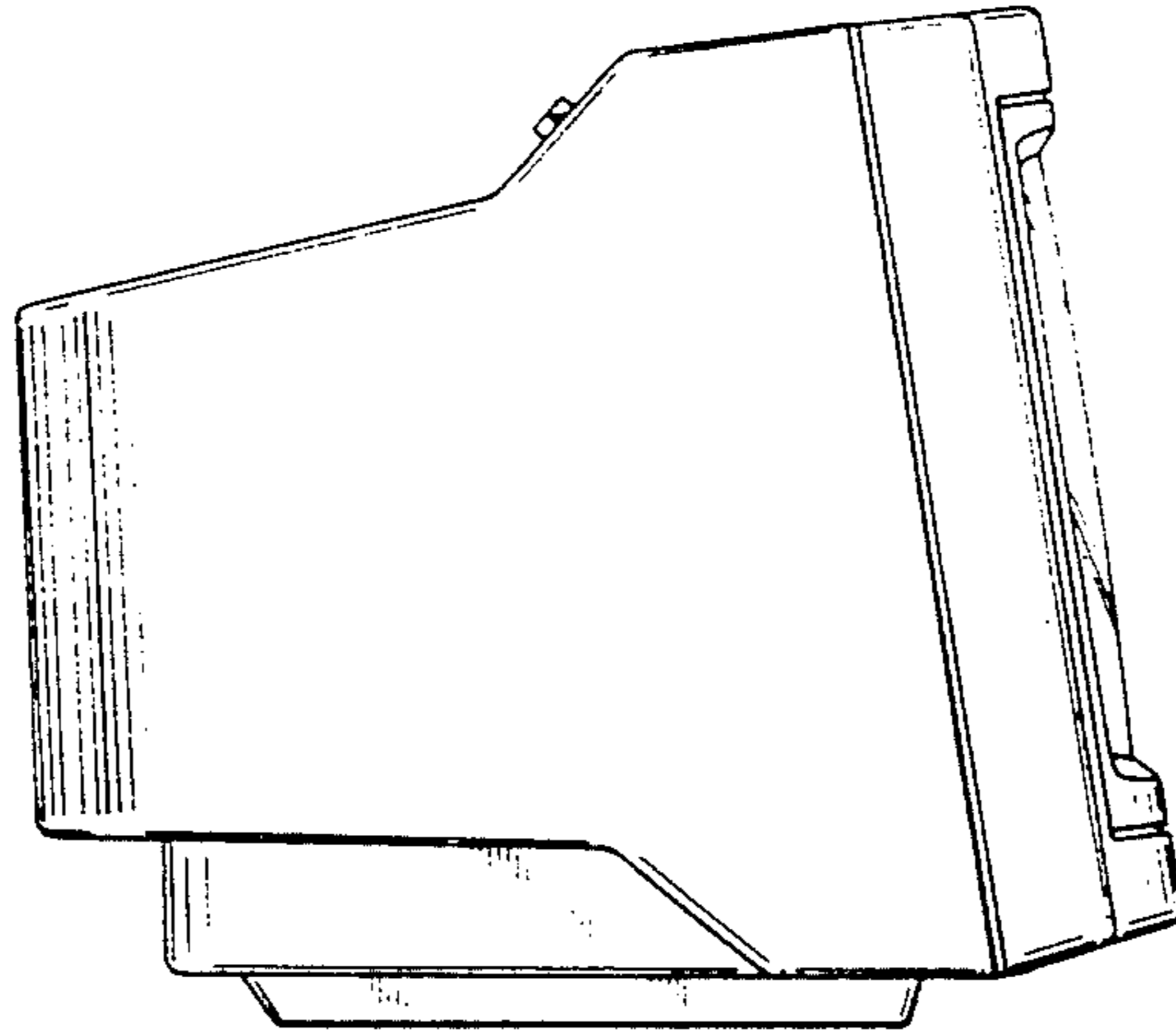

FIG. 6

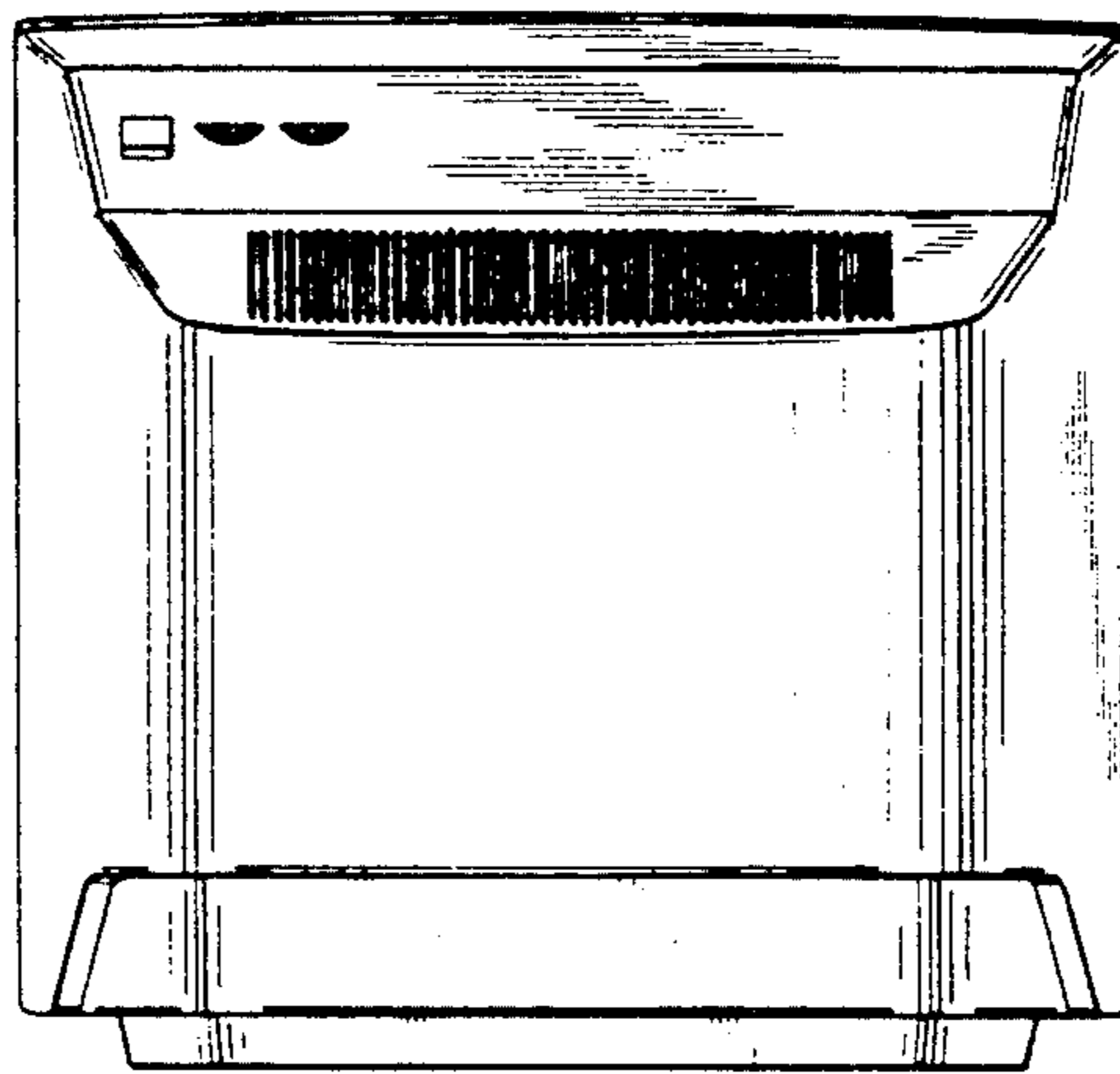

FIG. 7

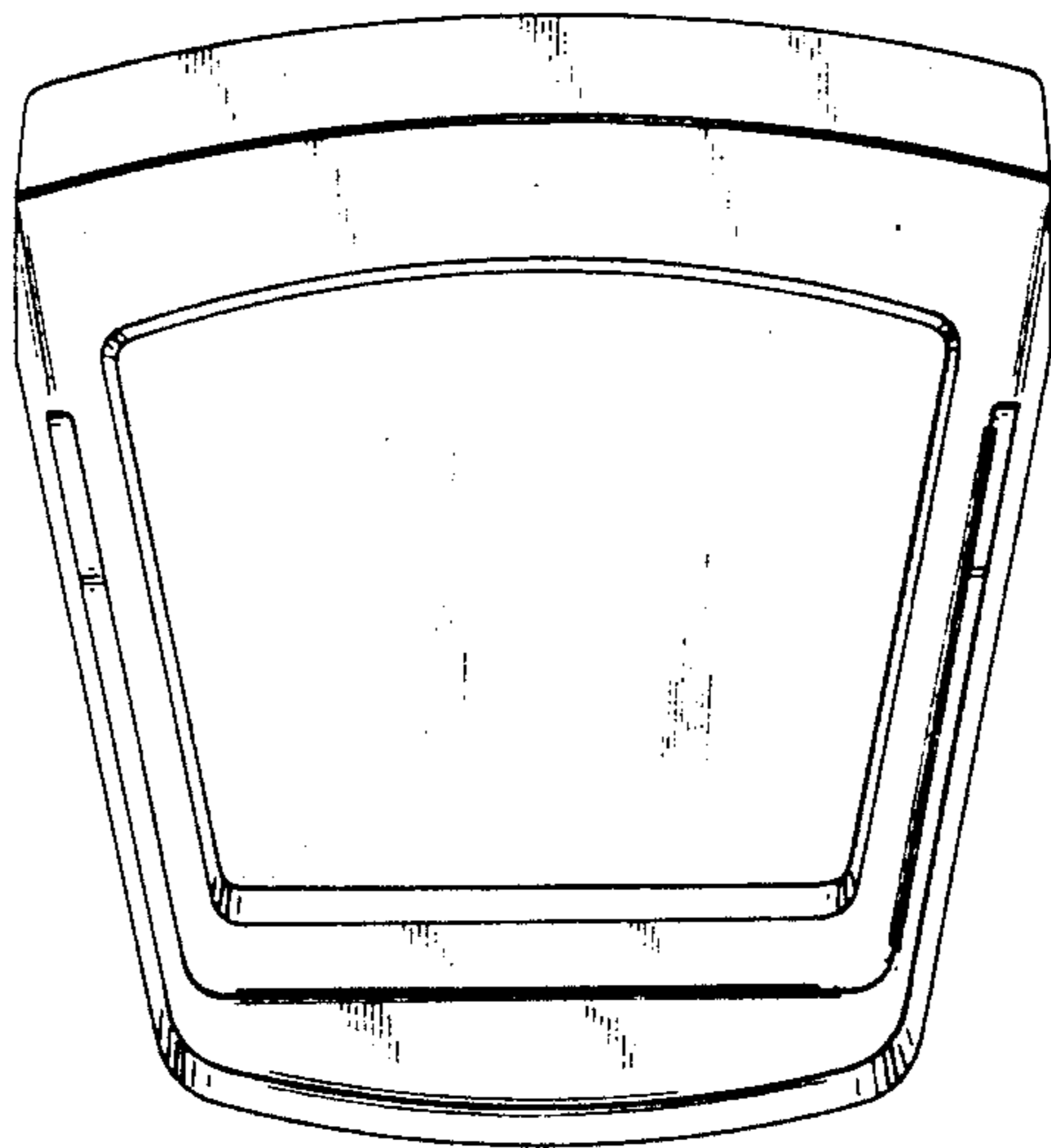

FIG. 8

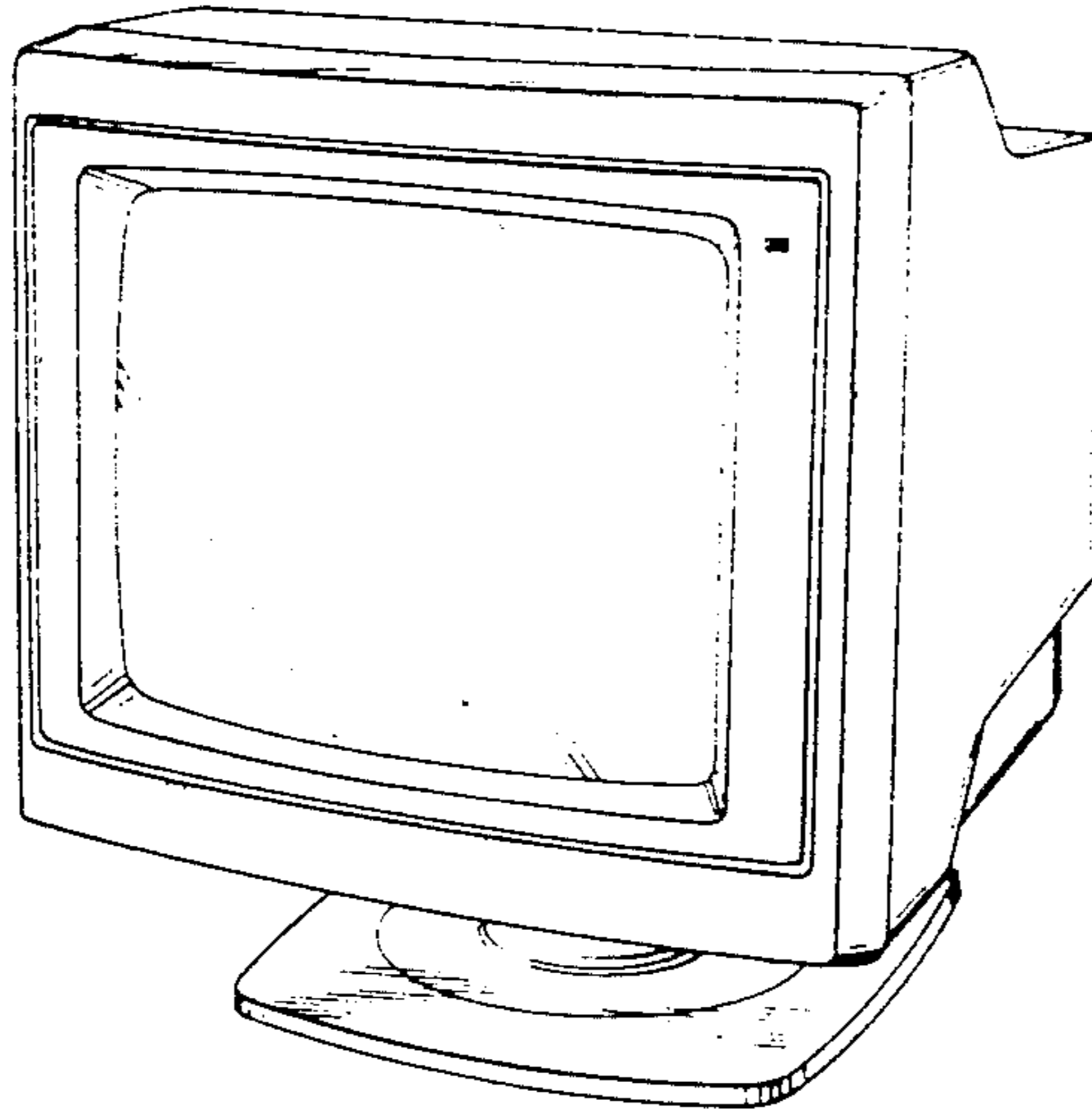

FIG. 9

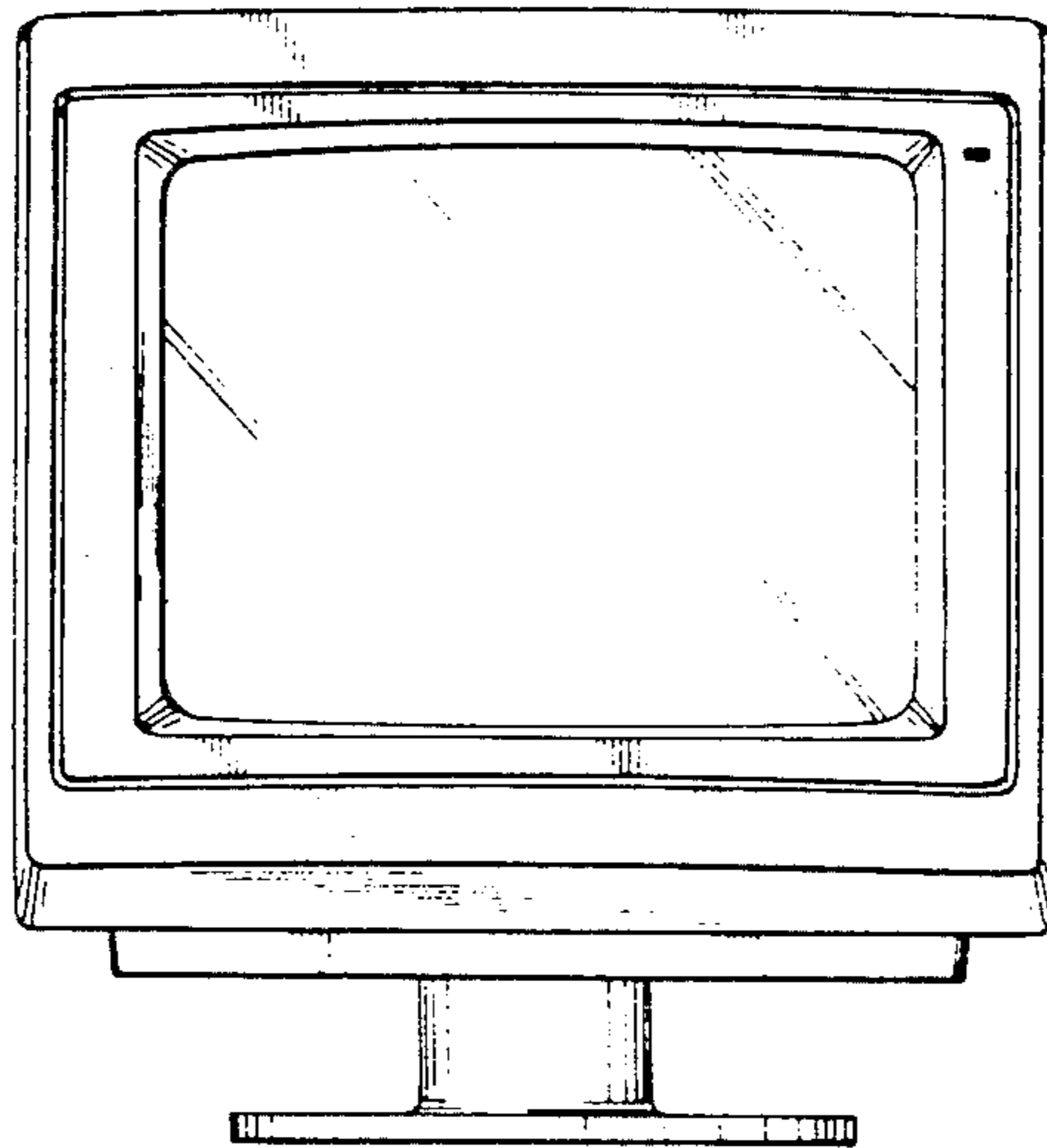

FIG. 10

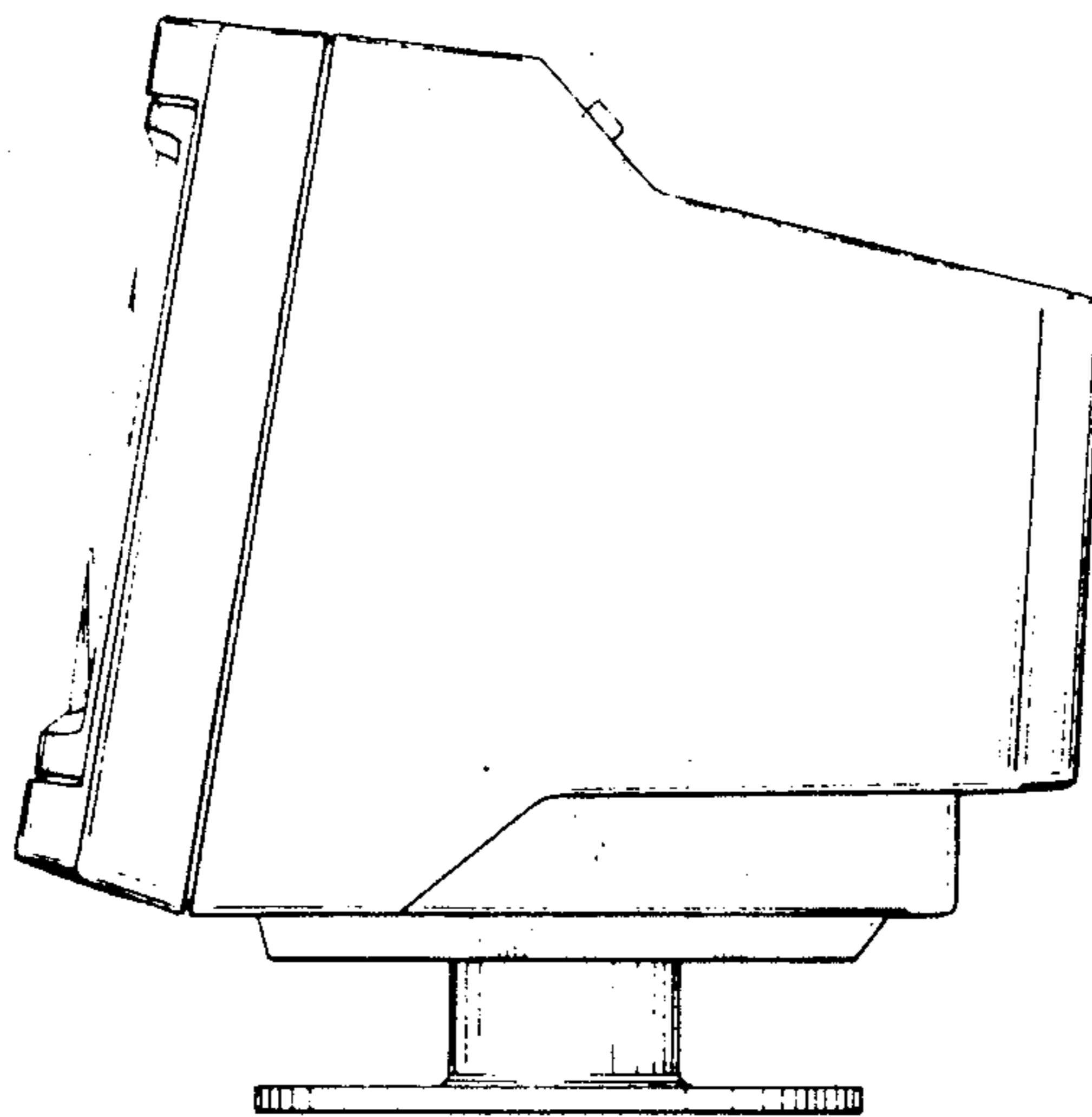

FIG. 11

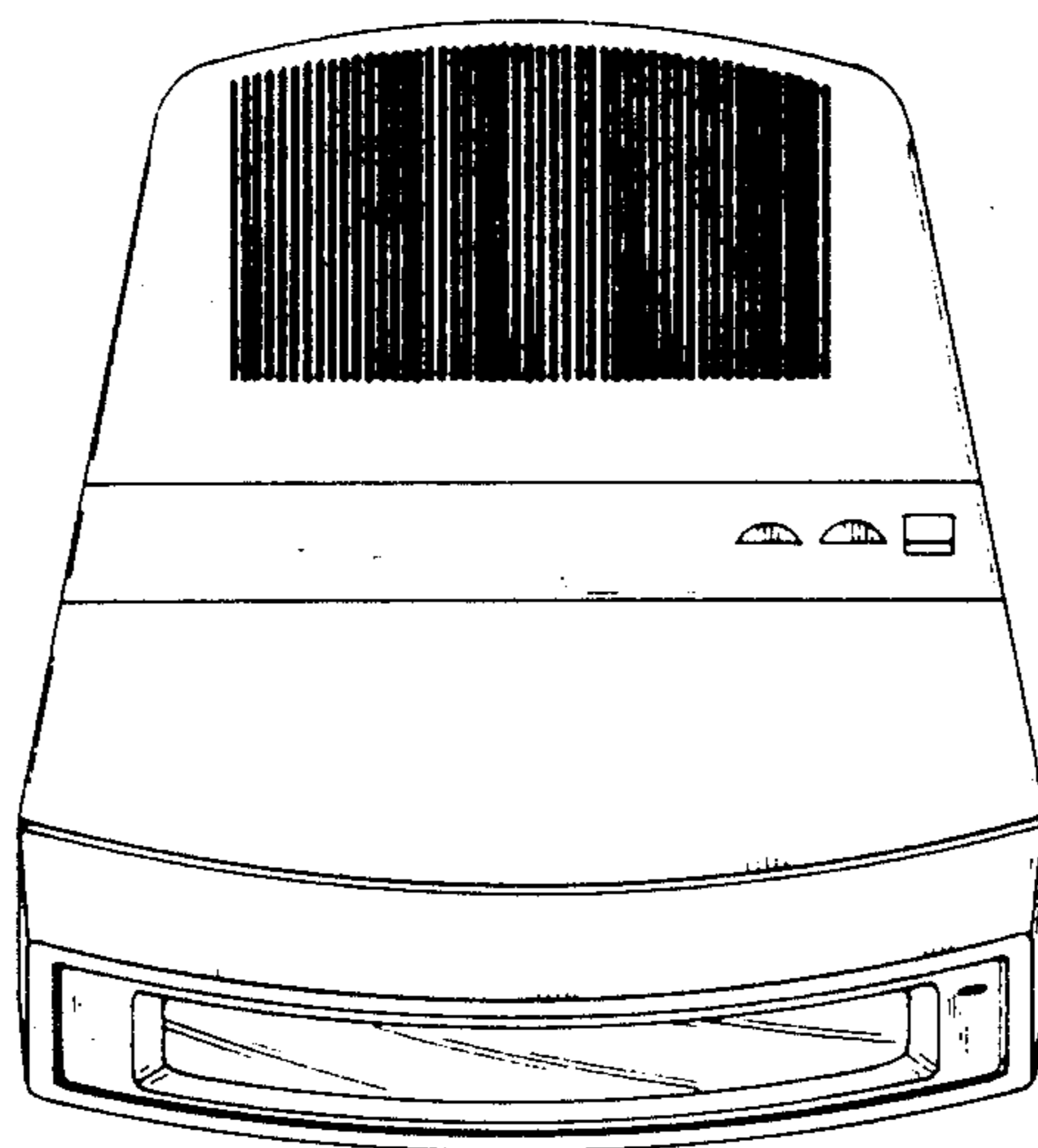

FIG. 12

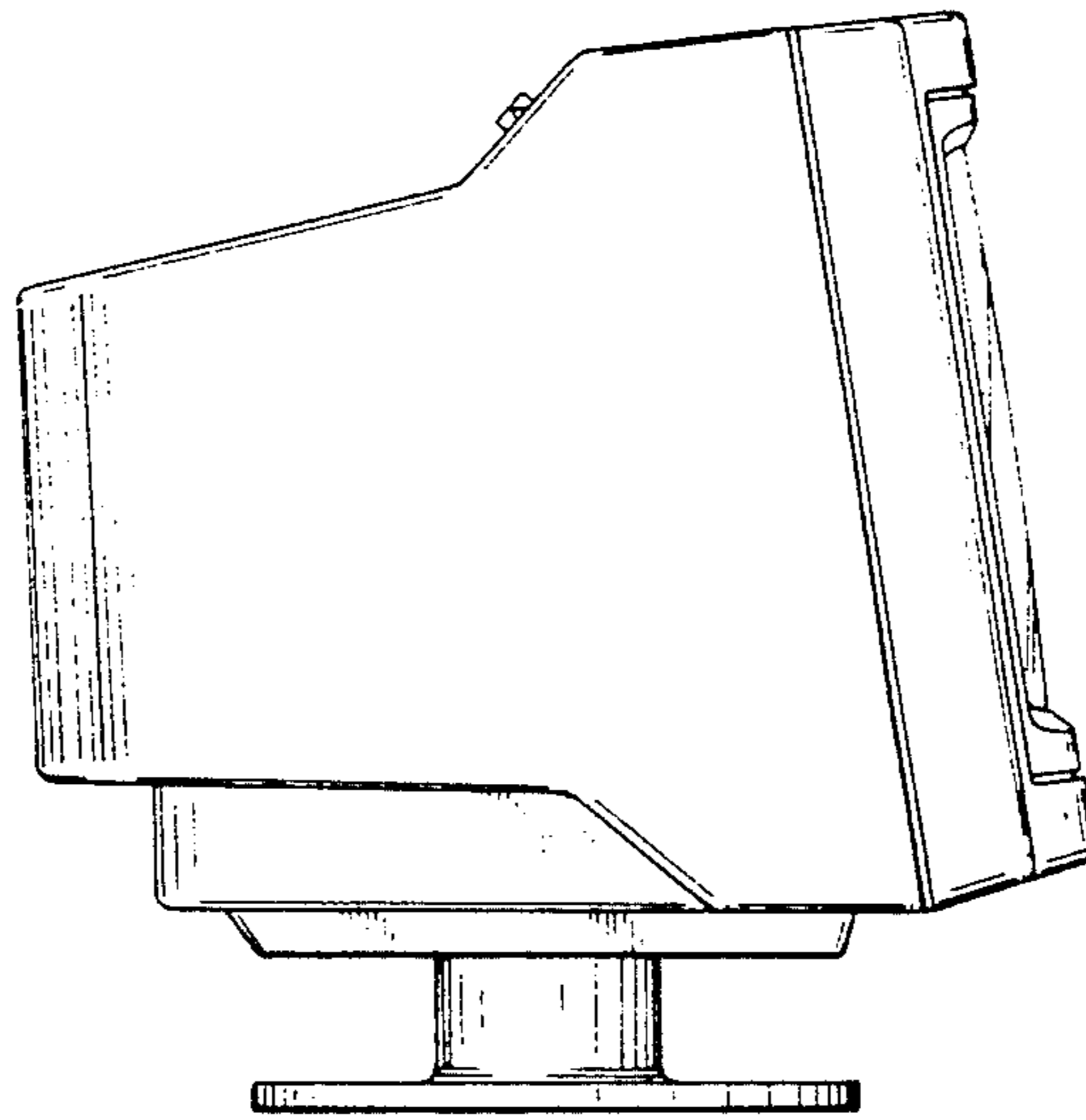

FIG. 13

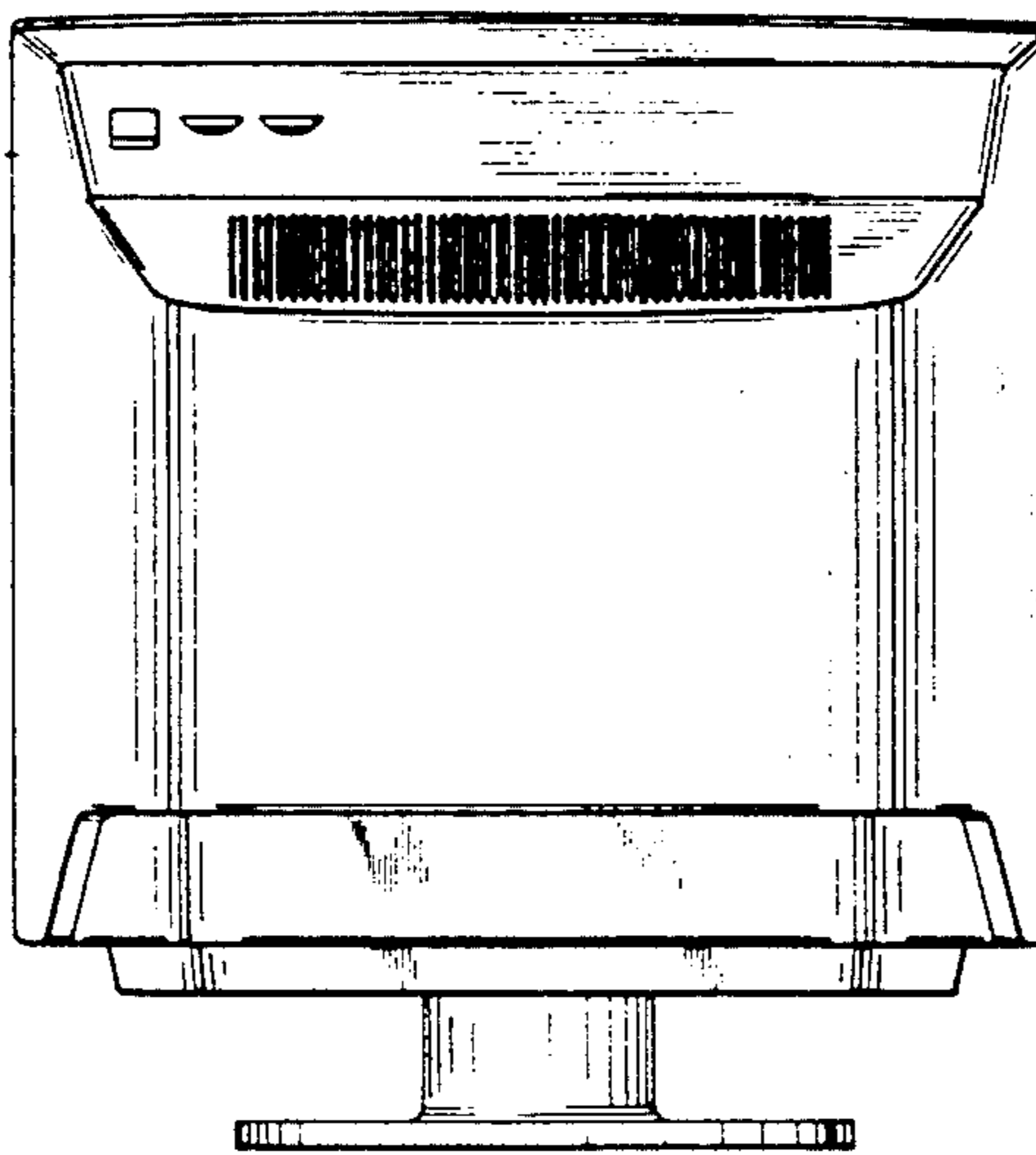

FIG. 14

