

[54] TABLE BASE

D. 271,551 11/1983 Rausch D6/495

[75] Inventor: William Doezema, Grand Rapids, Mich.

Primary Examiner—Bruce W. Dunkins
Attorney, Agent, or Firm—Thomas A. Briody; William J. Streeter

[73] Assignee: Baker, Knapp & Tubbs, Inc., Chicago, Ill.

[57] CLAIM

[**] Term: 14 Years

The ornamental design for a table base, as shown and described.

[21] Appl. No.: 543,187

DESCRIPTION

[22] Filed: Oct. 18, 1983

[52] U.S. Cl. D6/495; D6/489

[58] Field of Search D6/449, 461, 480, 484, D6/488, 489, 495, 497, 499

FIG. 1 is a perspective view of a table base showing my design;

FIG. 2 is a top plan view on a reduced scale;

FIG. 3 is a front elevational view of the table base of FIG. 2;

FIG. 4 is a right side elevational view of the table of FIG. 2, the left side being a mirror image thereof;

FIG. 5 is a bottom plan view of the table base of FIG. 2; and

FIG. 6 is a perspective view of a table base showing a second embodiment of my design.

[56] References Cited

U.S. PATENT DOCUMENTS

- D. 225,190 11/1972 Van Syoc D6/336
- D. 234,068 1/1975 Mudde D6/489 X
- D. 237,336 10/1975 Loscalzo et al. D6/489 X
- D. 269,830 7/1983 Nijhuis D6/373

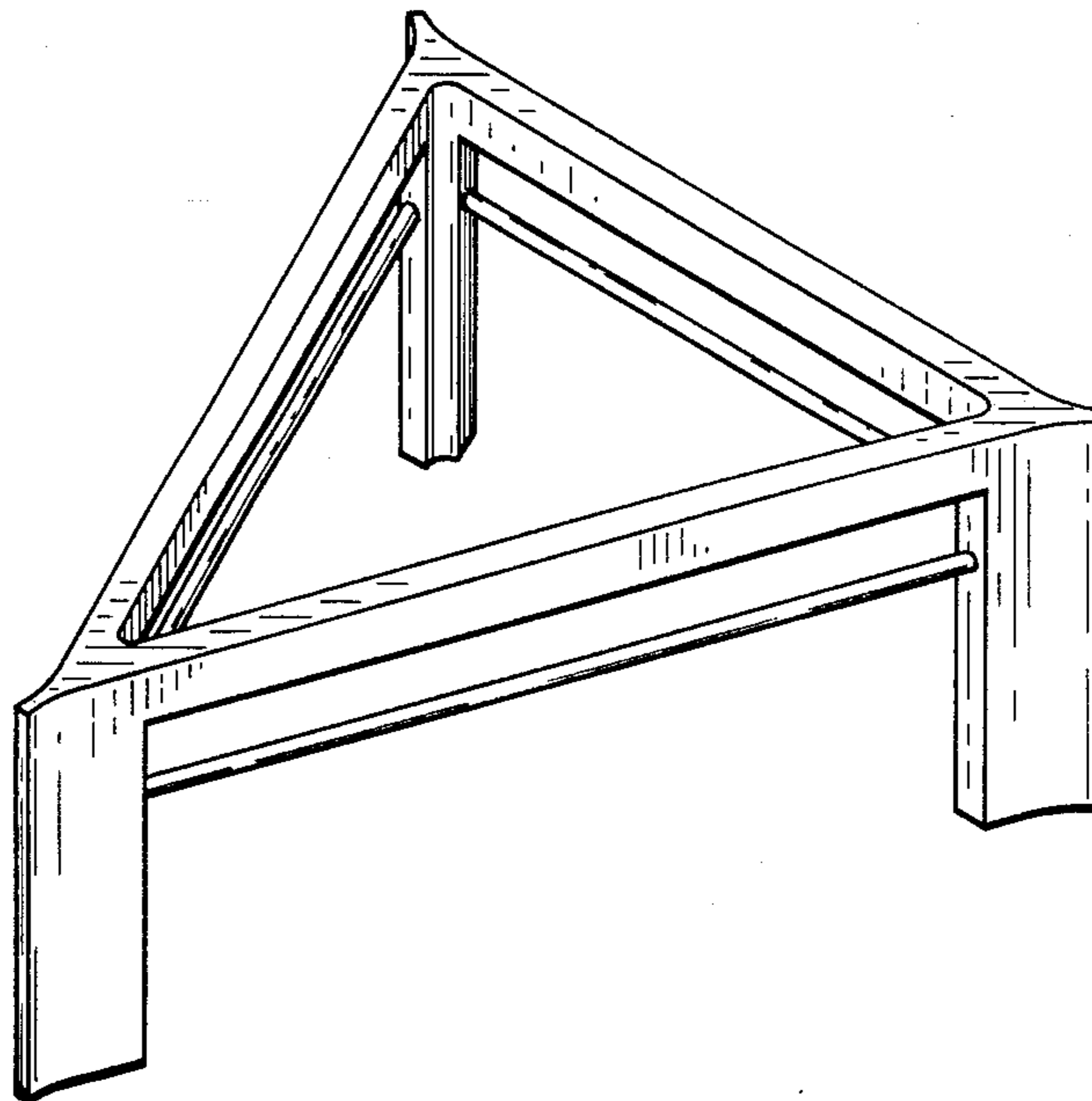

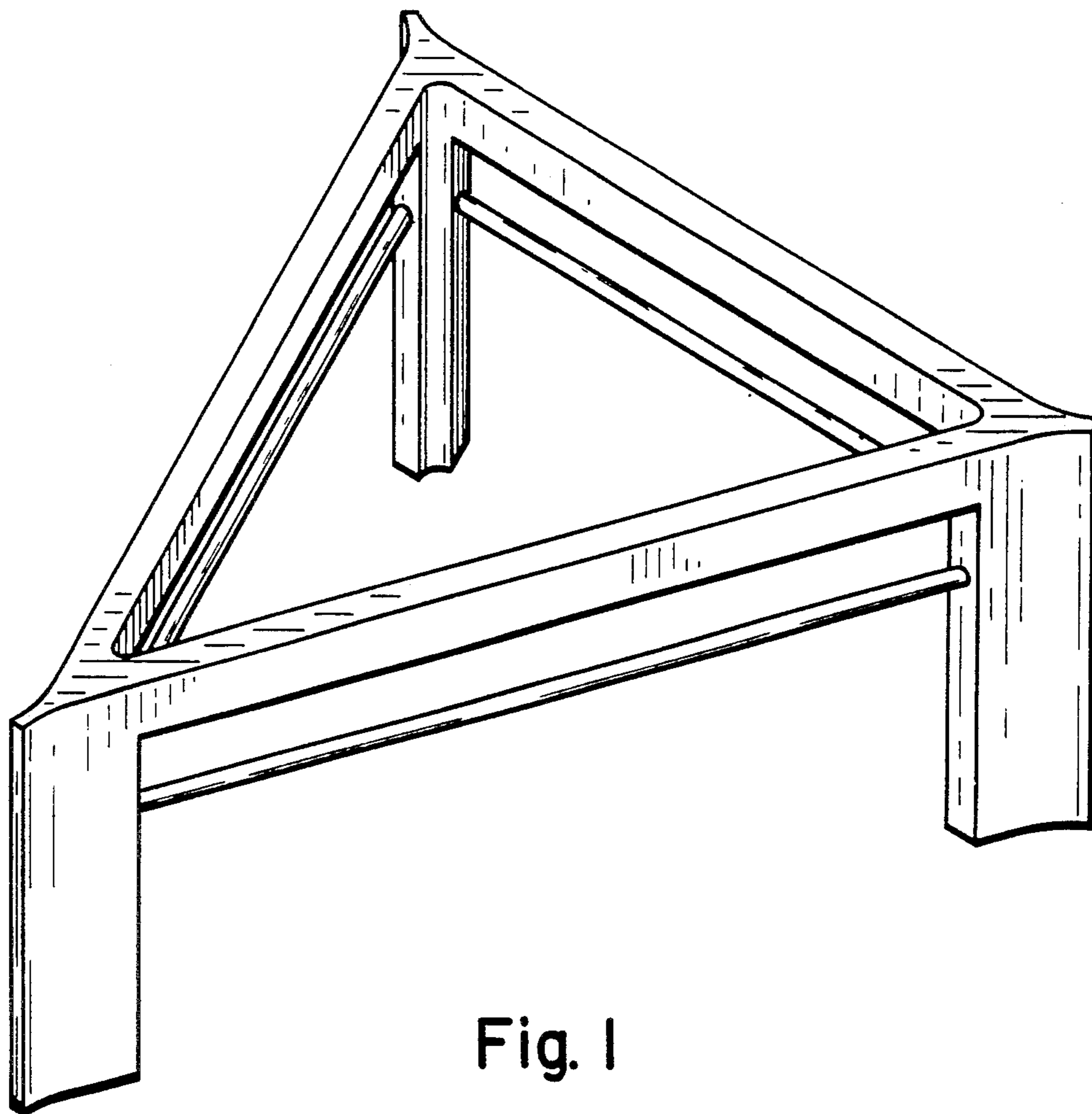

Fig. 1

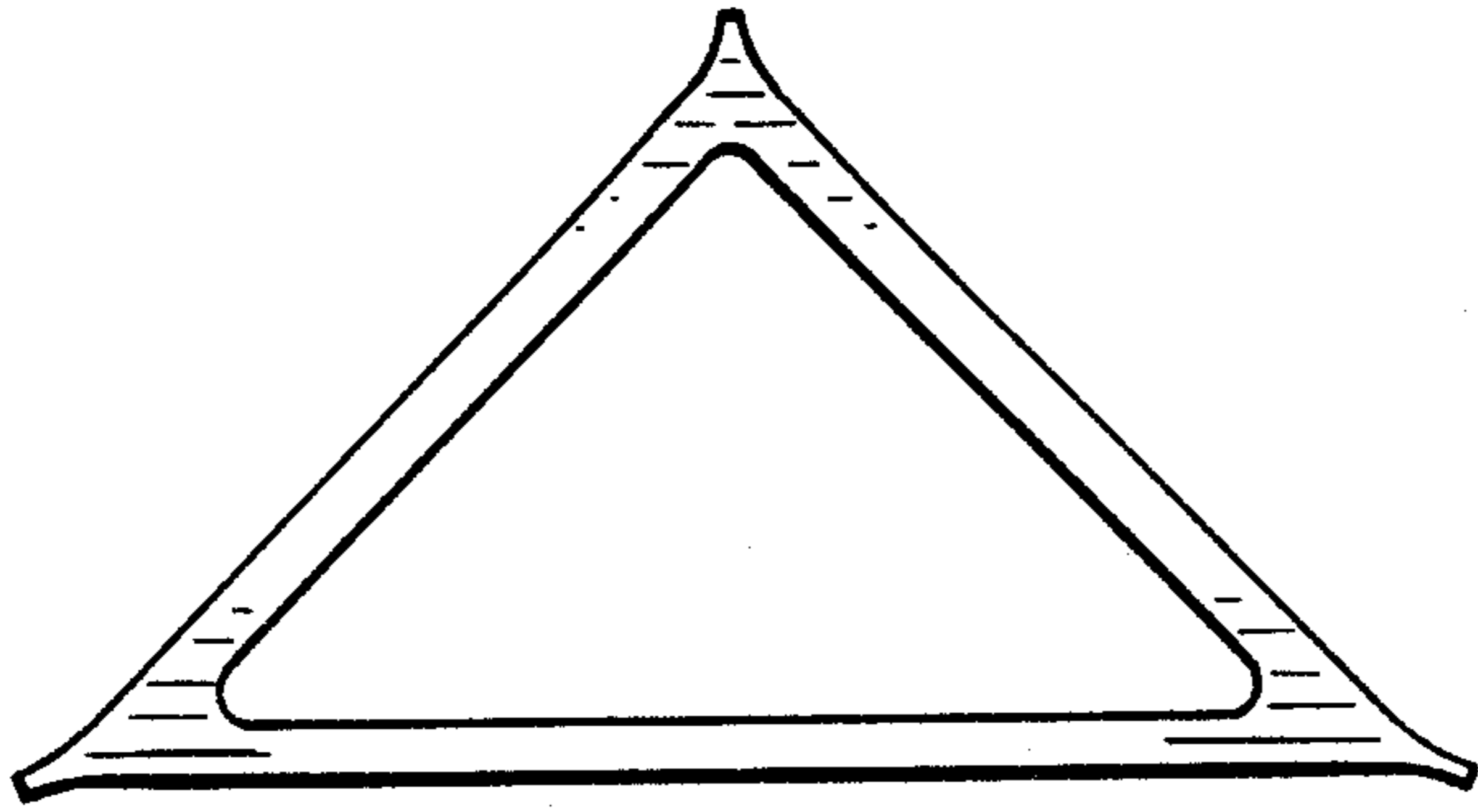

Fig. 2

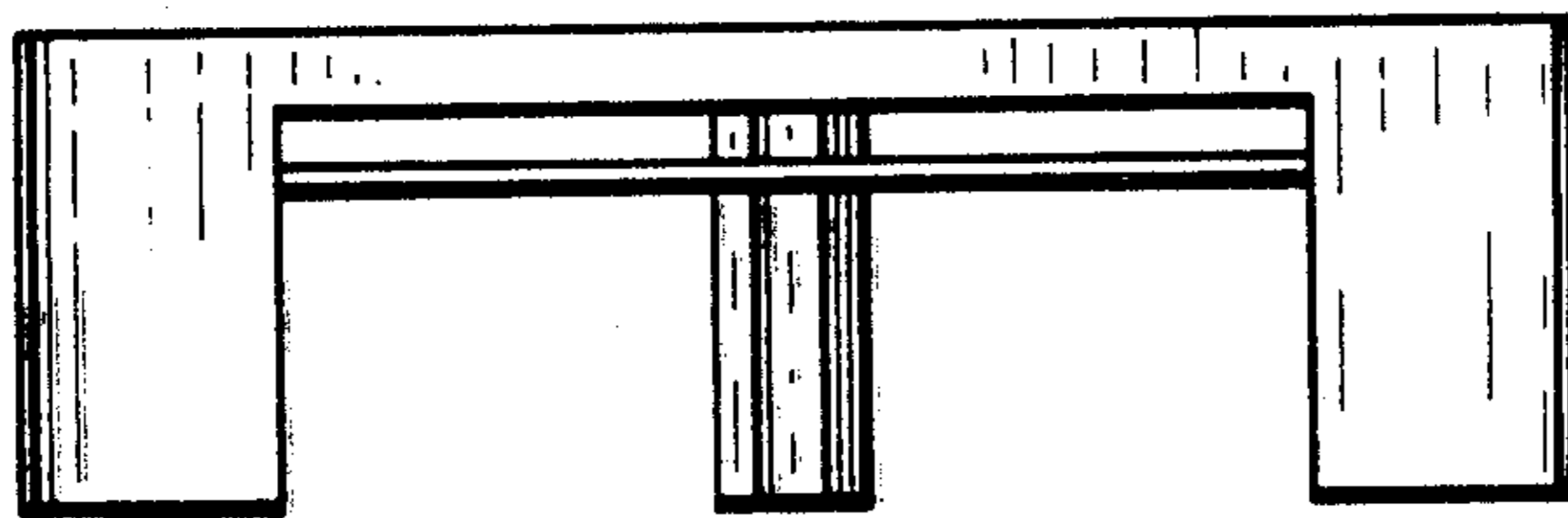

Fig. 3

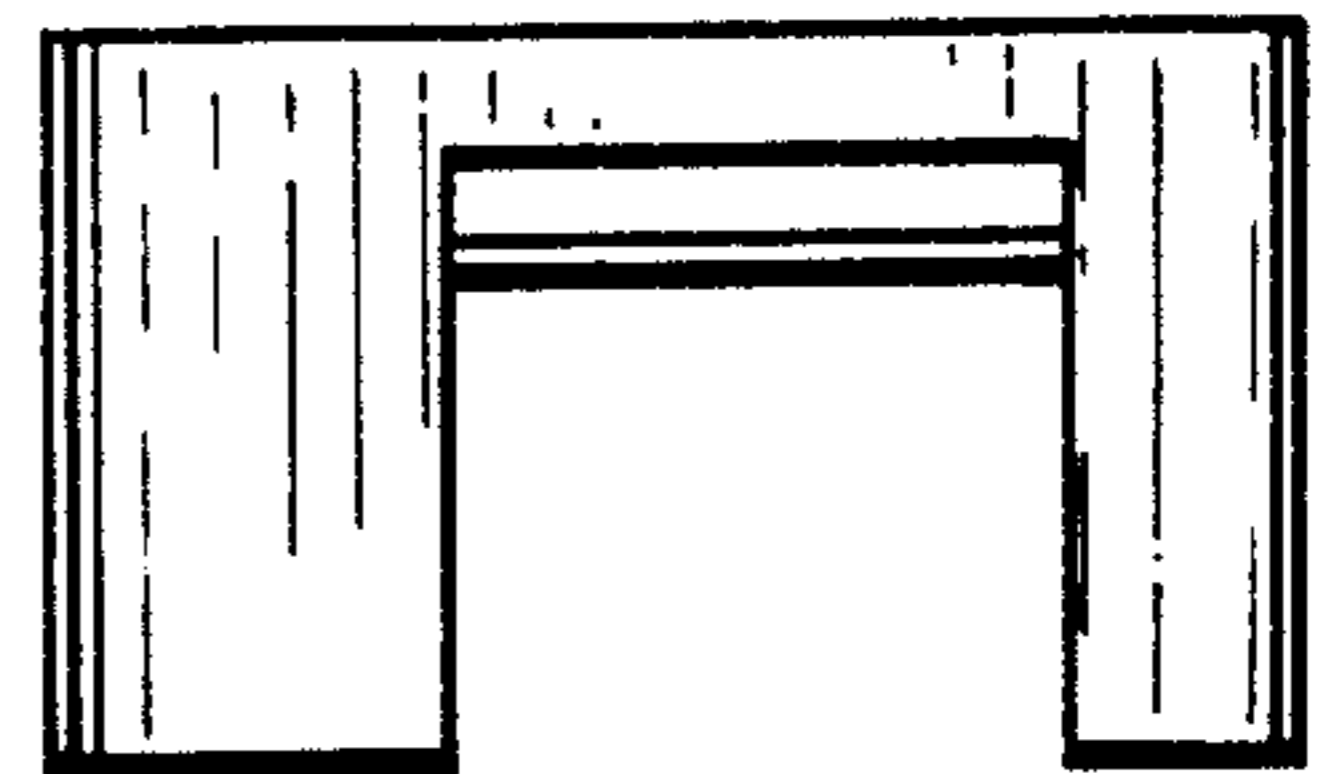

Fig. 4

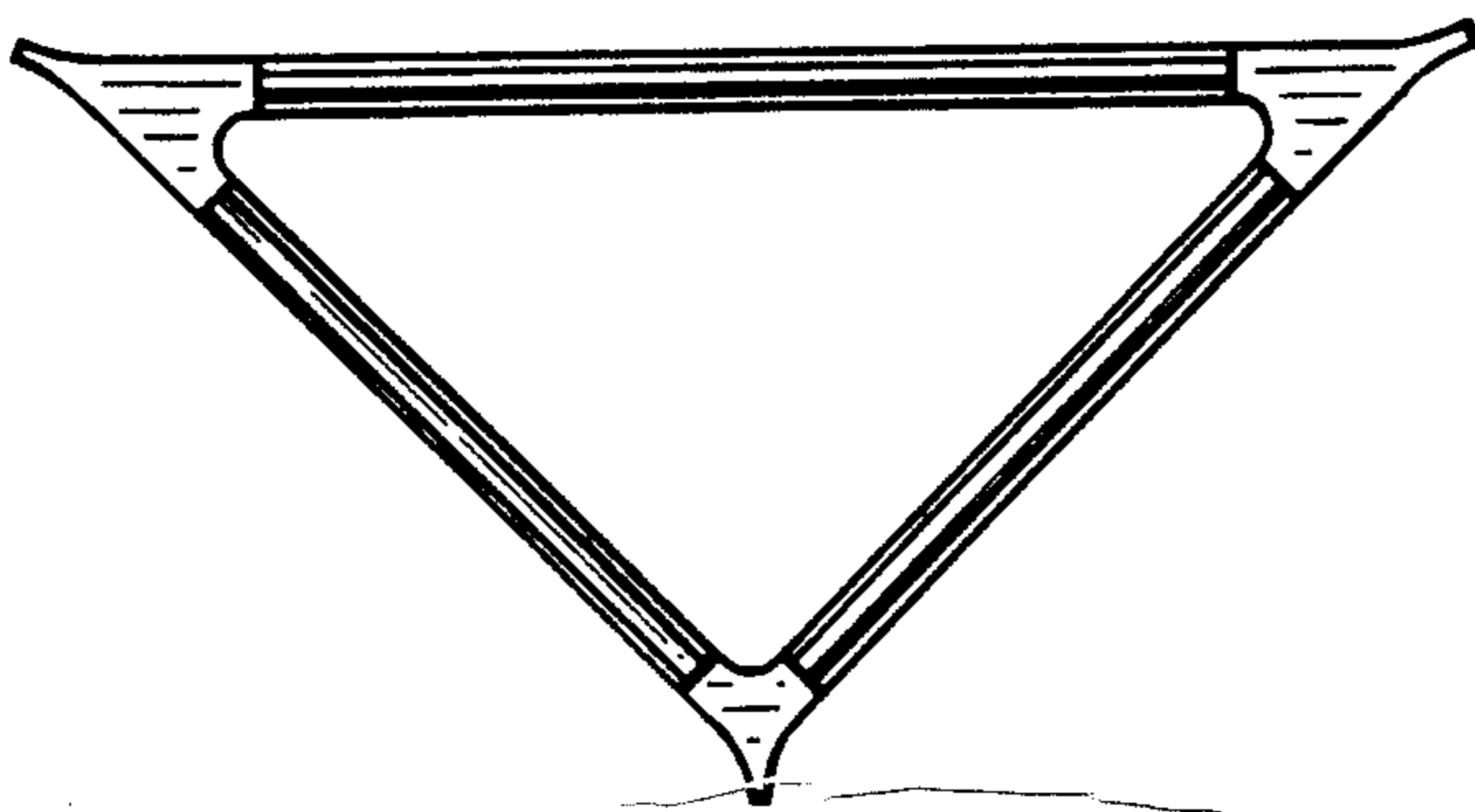

Fig. 5

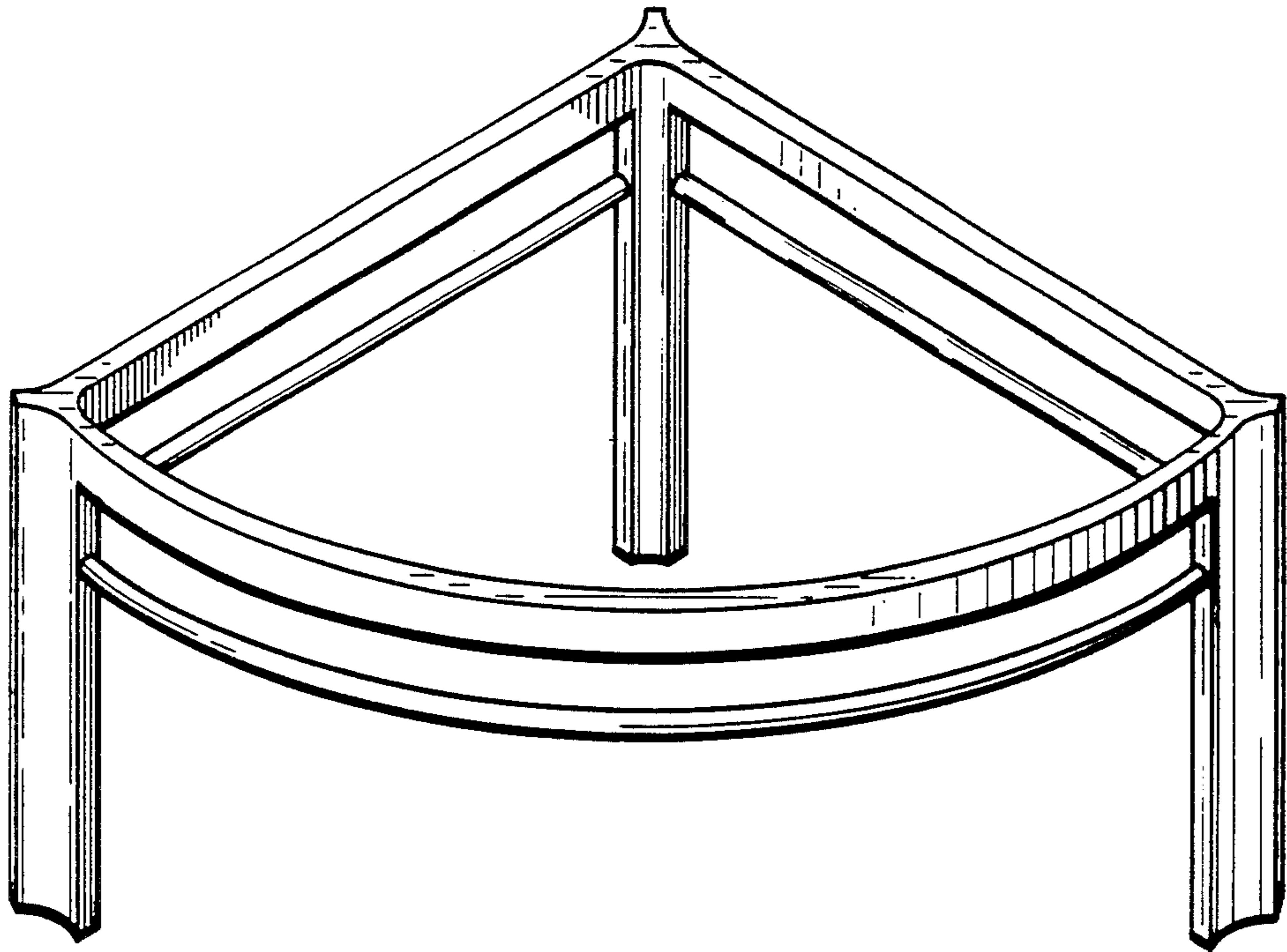

Fig. 6