

[54] **TELEPHONE SET**

[76] **Inventor:** Thomas J. Tizzard, 804 Bristol Rd., San Dimas, Calif. 91773

[**] **Term:** 14 Years

[21] **Appl. No.:** 608,166

[22] **Filed:** May 8, 1984

Related U.S. Application Data

[63] Continuation-in-part of Ser. No. 553,121, Nov. 18, 1983, which is a continuation-in-part of Ser. No. 554,224, Nov. 21, 1983, which is a continuation-in-part of Ser. No. 561,274, Dec. 14, 1983, which is a continuation-in-part of Ser. No. 561,276, Dec. 19, 1983.

[52] **U.S. Cl.** D14/53; D14/63; D14/62; 179/179; D14/69

[58] **Field of Search** D14/52, 53, 63, 59, D14/60, 69, 62, 72; 179/179, 100 D, 100 R, 102; D9/420, 428, 337, 432, 345

References Cited

U.S. PATENT DOCUMENTS

D. 193,729	10/1962	Graban	D21/147
D. 224,024	6/1972	De Luce	D14/52
D. 231,742	6/1974	Genaro et al.	D14/60
D. 249,800	10/1978	Yates et al.	D22/1
D. 256,689	9/1980	McCain	D14/52
D. 259,420	6/1981	Genaro et al.	D14/60
2,375,879	5/1945	Wright	D21/147 X
3,546,396	12/1970	Marcheschi et al.	179/178

OTHER PUBLICATIONS

Gun World—Sep. 1975; p. 21; "LLAMA" 45.
Guns & Ammo Mag.; Aug. 1979; Sundry showings of 45 small arms similar to claimed simulator transceiver.

Ohio Art Co. Catalog, 1966—Fall & Winter: Jaguar-matic pistol No. 717 at p. 15.

Gun World, Sep. 1977; pp. 68-69; Showing of Browning 51 G/Sager.

C&P Brochure re. AT&T Design Line Phones; Showings of "Stowaway, ChestPhones & Optique" phone enclosures.

Retail Home Furnishings (Supplement) 1-23-78: See ITT "Jewel Box Phone and Phone in a Chest".

Grandcom Inc. Catalog, "Hunting Scene Box Phone", at p. 10.

Ohio Art Co. Fall & Winter Catalog—1966; Showing of Revolvers in Box; Models 707, 704, 713, 711.

Primary Examiner—Wallace R. Burke

Assistant Examiner—Horace B. Fay

Attorney, Agent, or Firm—Antonelli, Terry & Wands

[57] **CLAIM**

The ornamental design for a telephone set, as shown.

DESCRIPTION

FIG. 1 is a perspective view of the container of a telephone set in closed position showing my new design;

FIG. 2 is a side elevational view thereof;

FIG. 3 is a rear elevational view thereof;

FIG. 4 is a top plan view thereof;

FIG. 5 is a front, right side perspective view from above showing the hand-gun transceiver handset and rotative dialer of the telephone set positioned within the opened container;

FIG. 6 is a side elevational view of the set as shown in FIG. 5;

FIG. 7 is a top plan view of the set as shown in FIG. 5 with the transceiver handset removed from the container; and

FIG. 8 is a top plan view of a second embodiment of the telephone set as shown in FIG. 5 with the sole difference being the substitution of a pushbutton dialer for the rotative dialer.

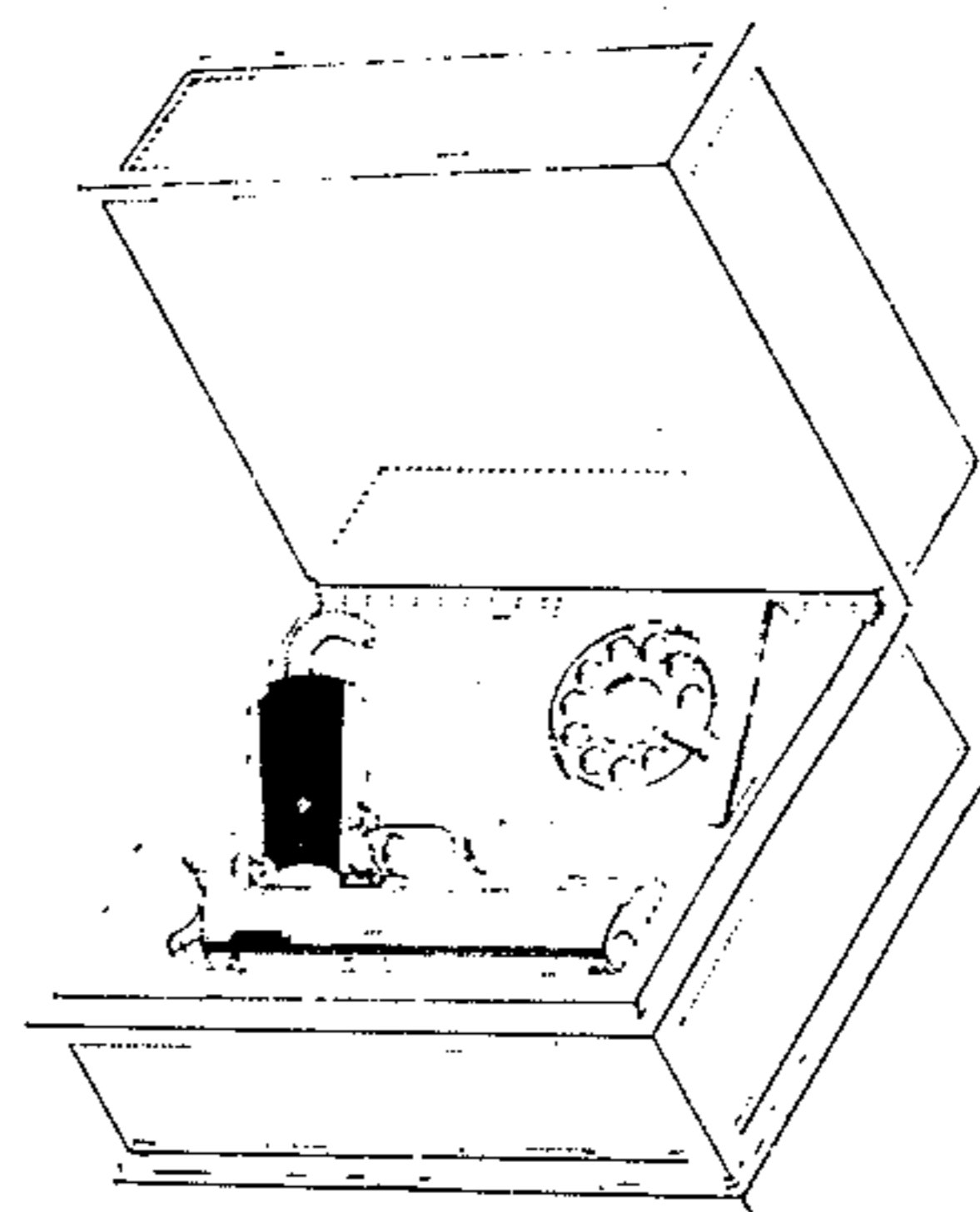
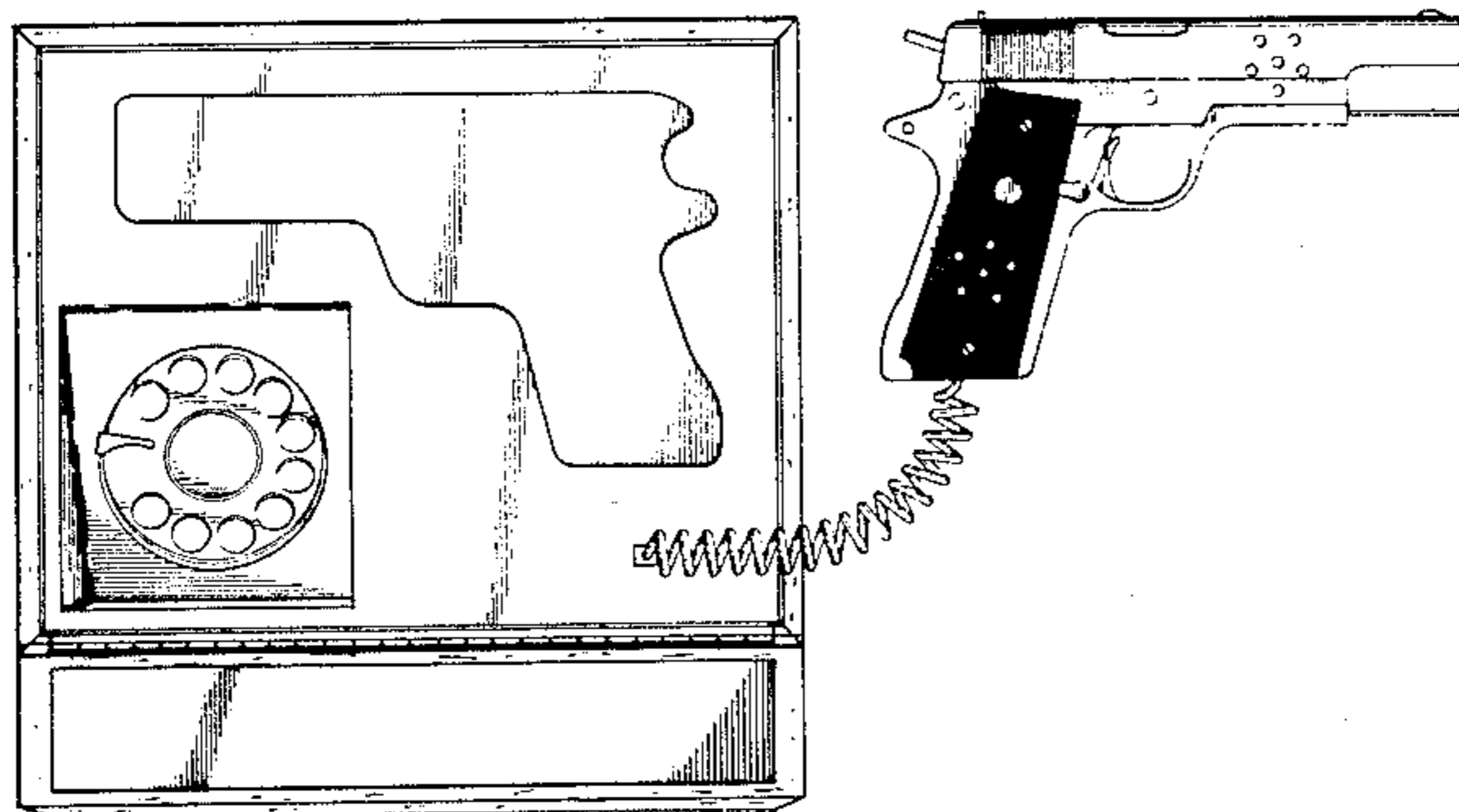

FIG. 1.

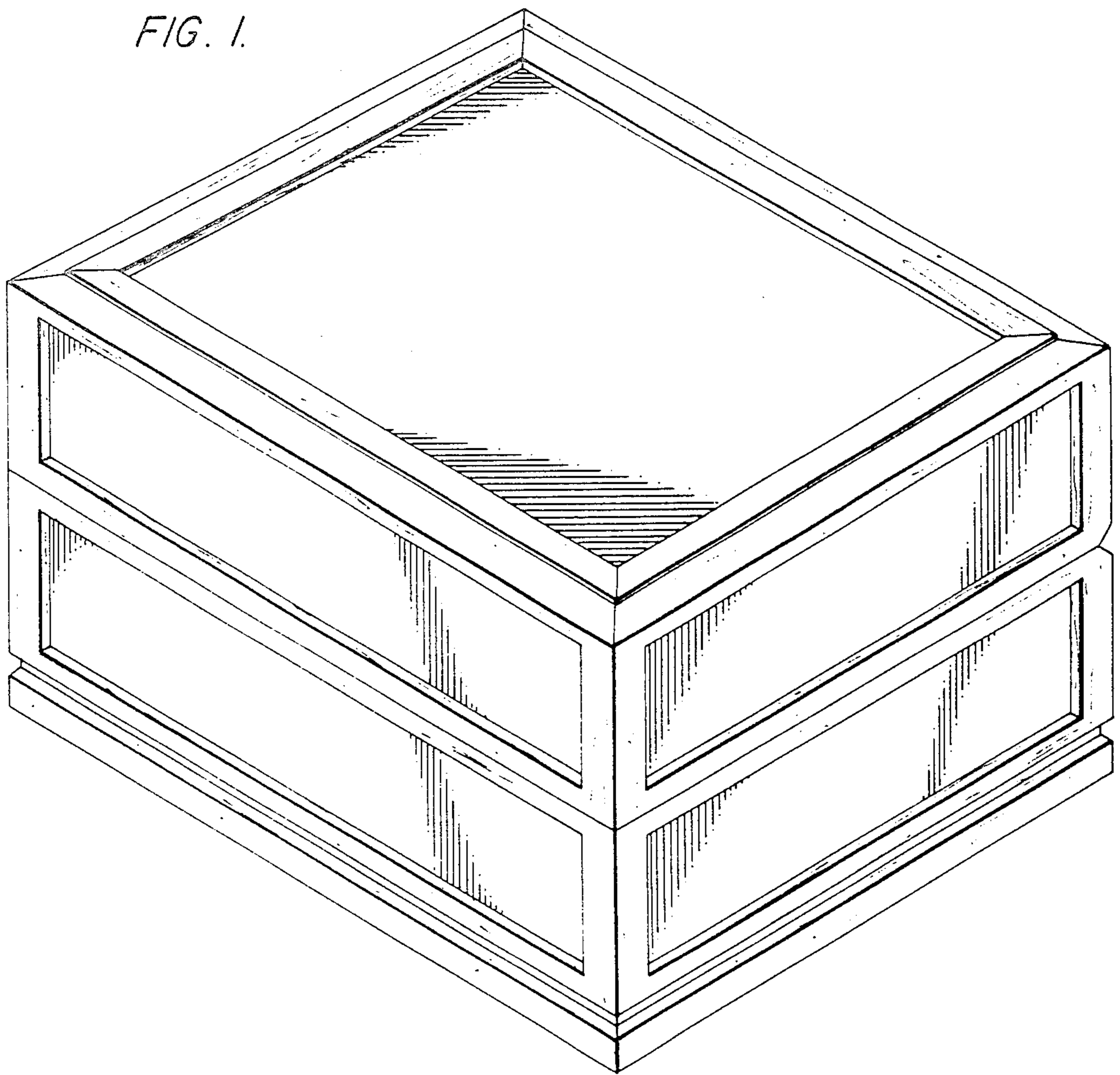

FIG. 2.

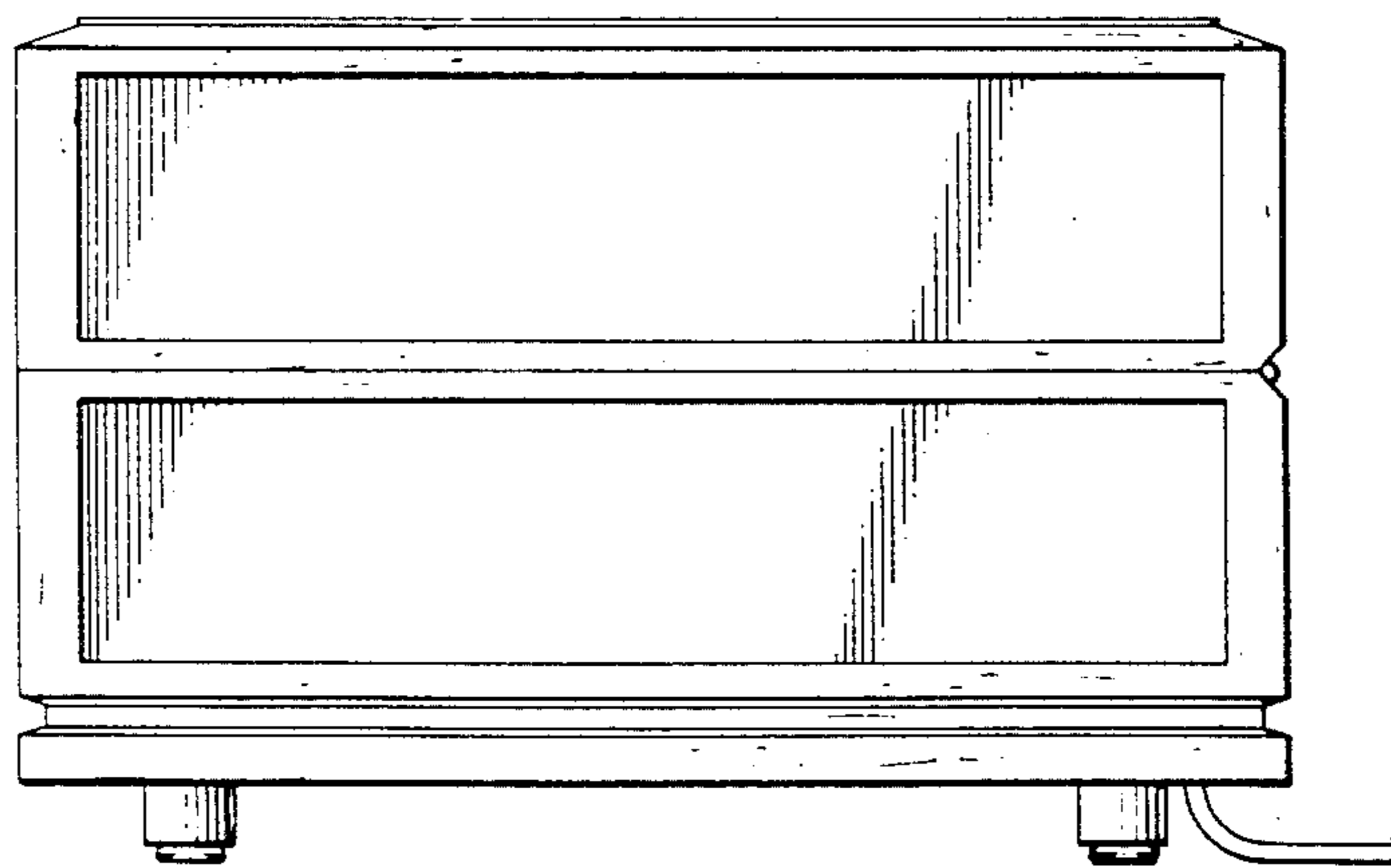

FIG. 3.

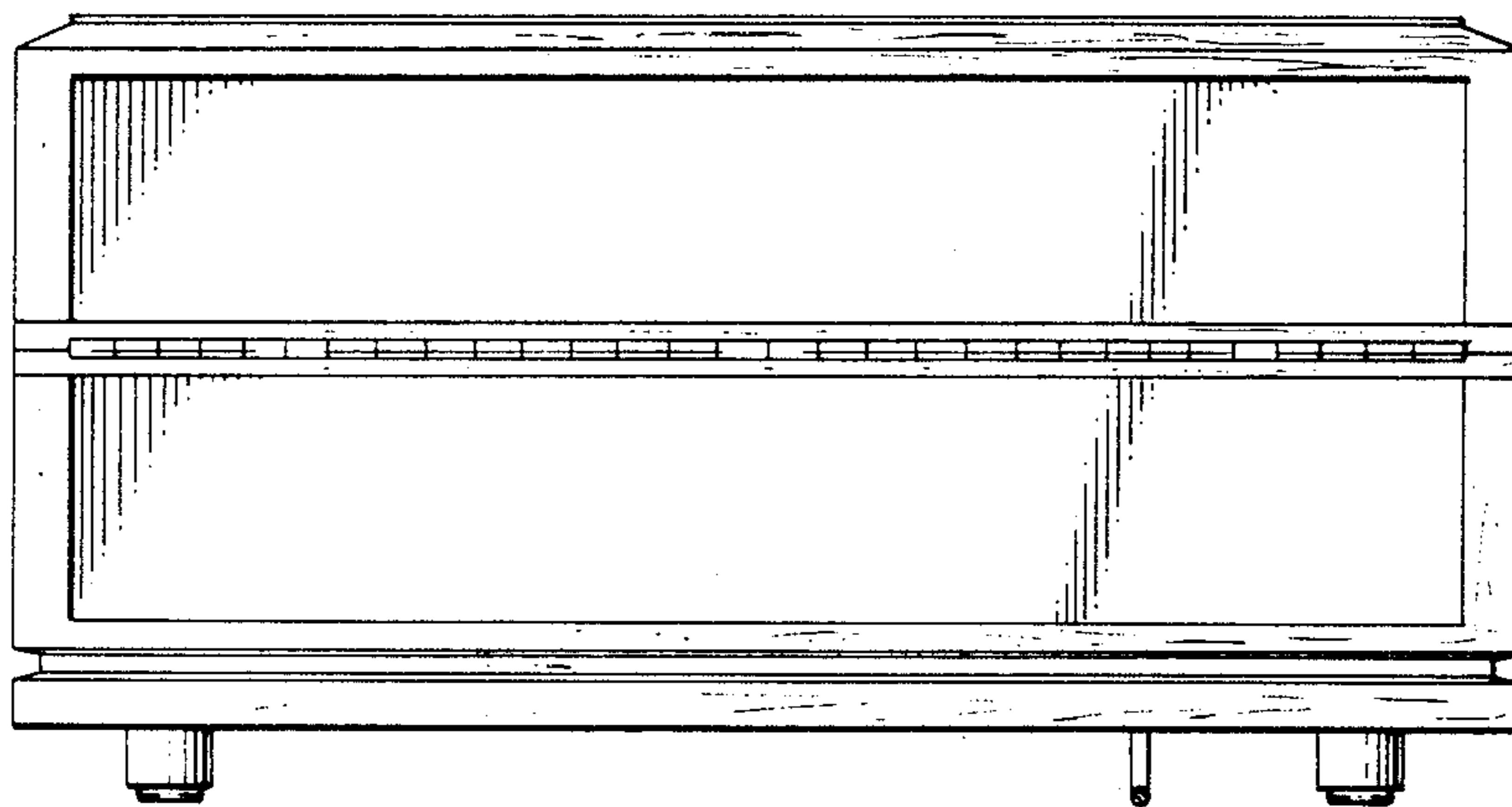

FIG. 4.

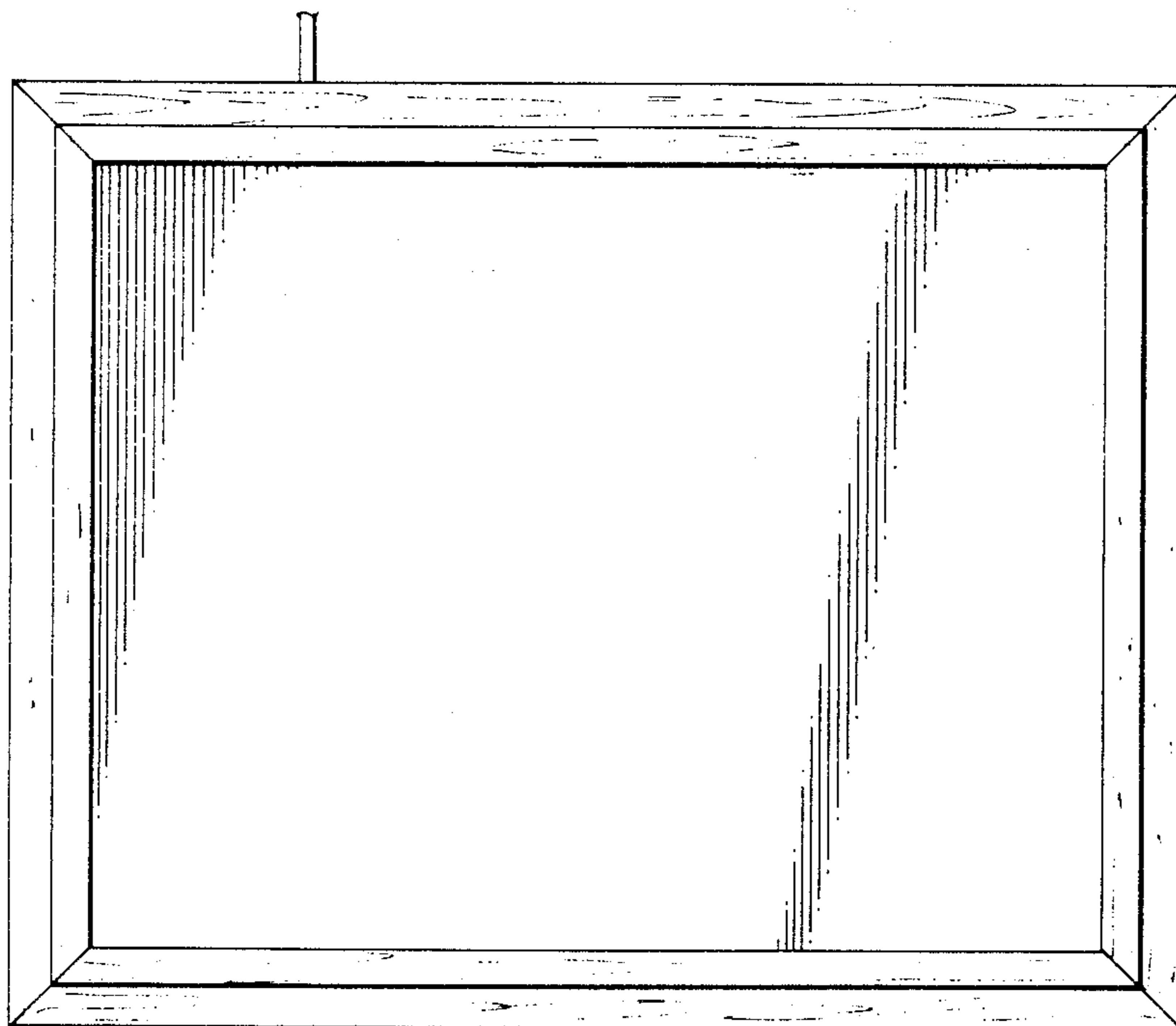

FIG. 5.

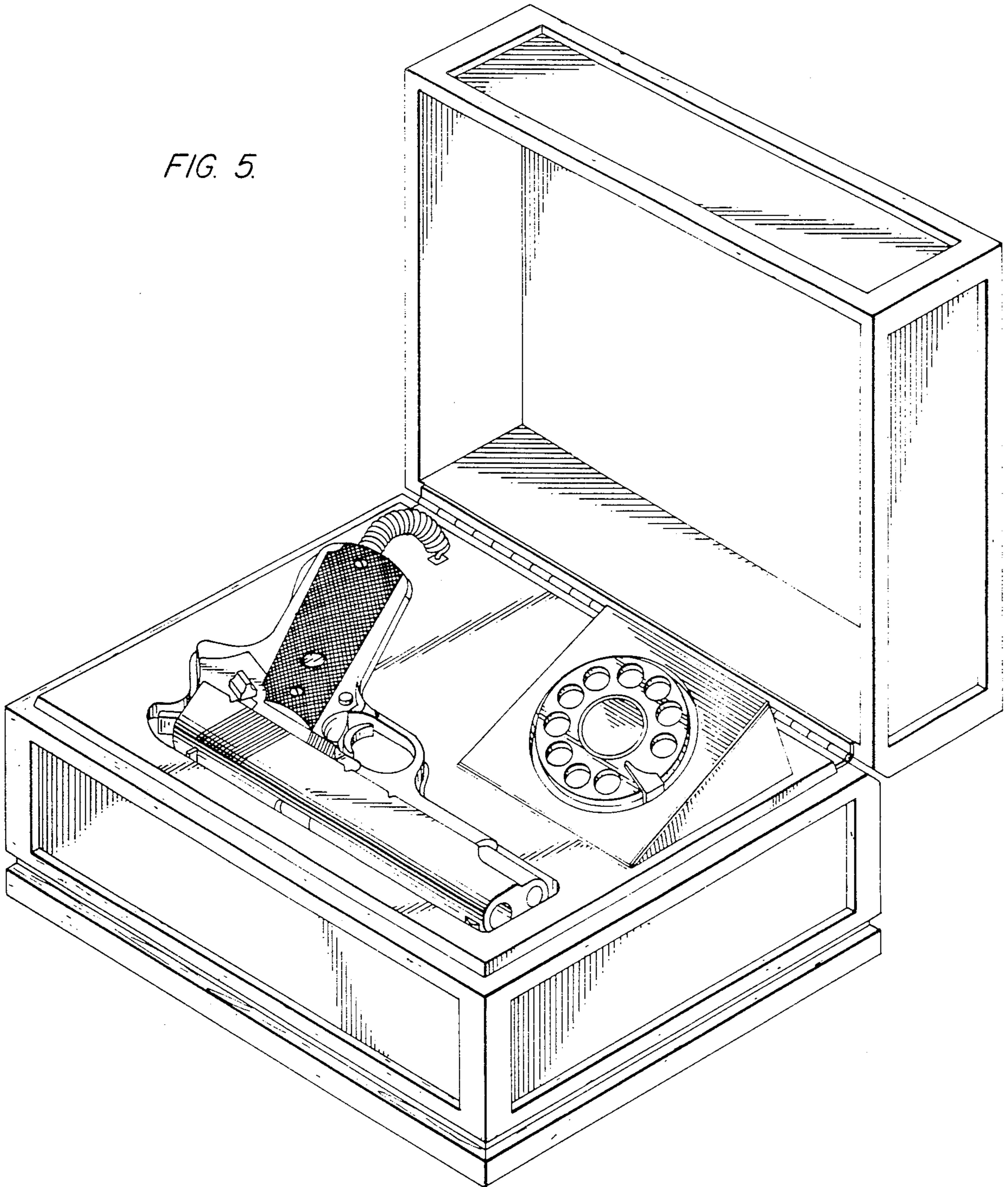

FIG. 8.

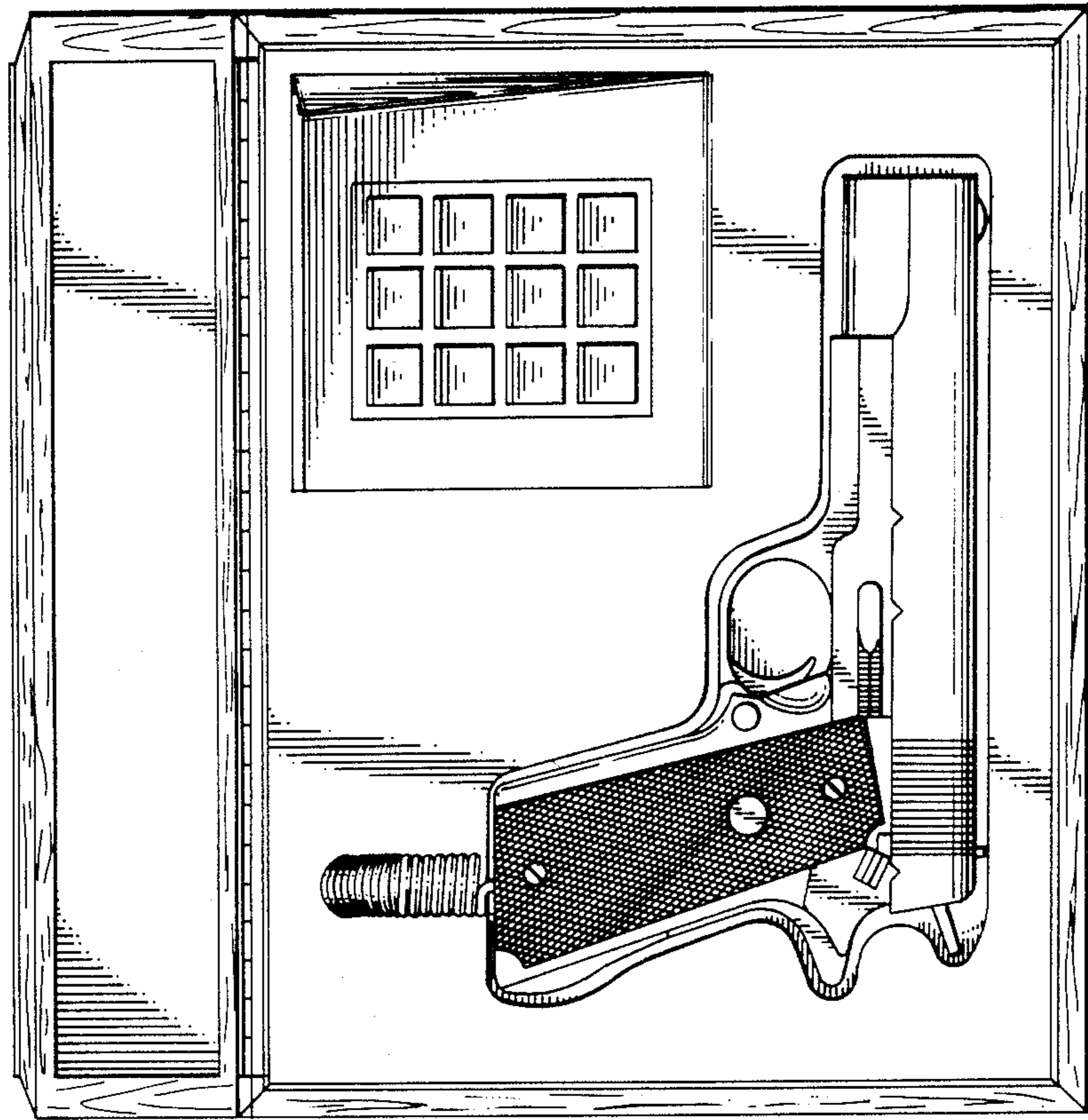
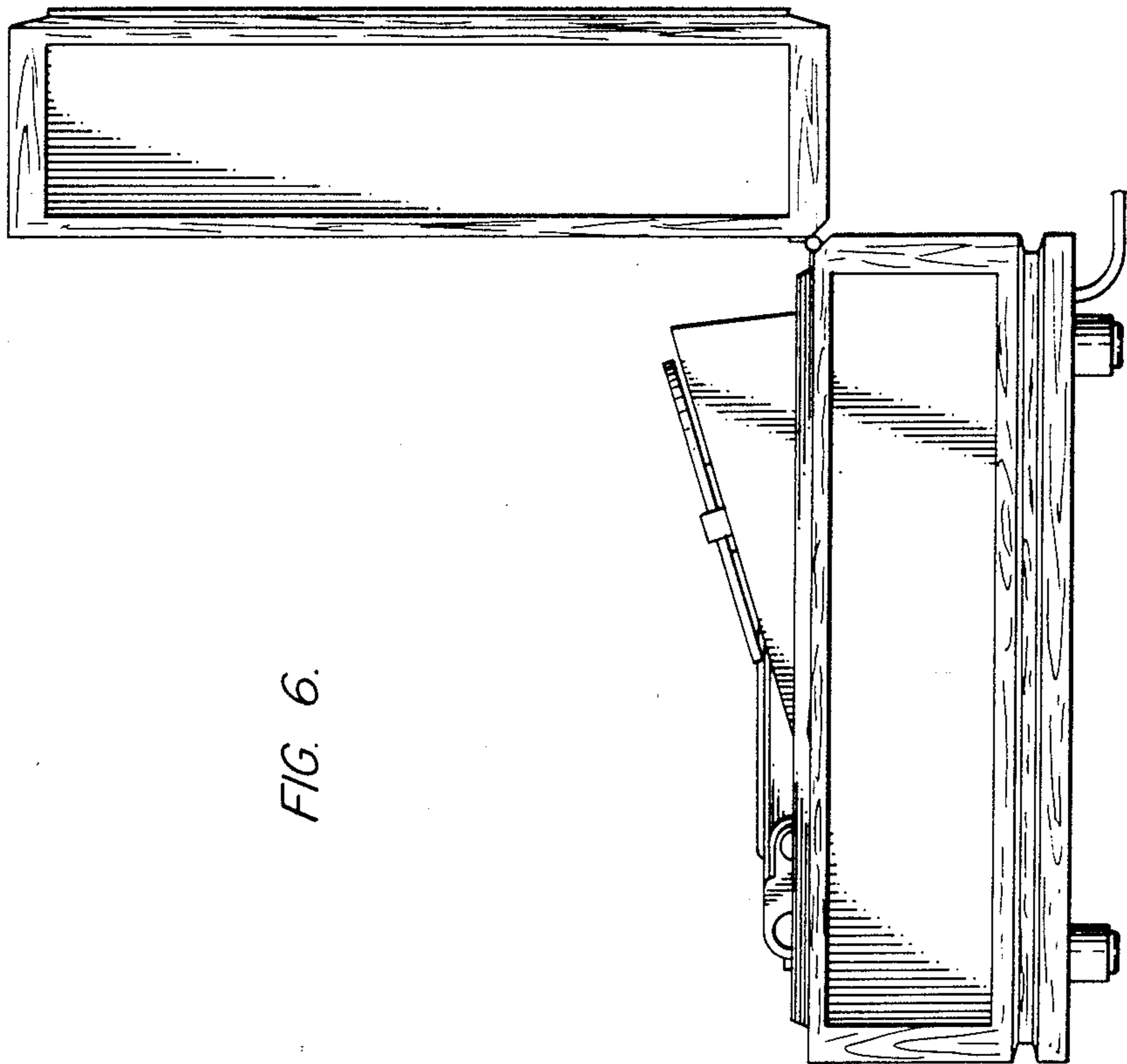

FIG. 6.



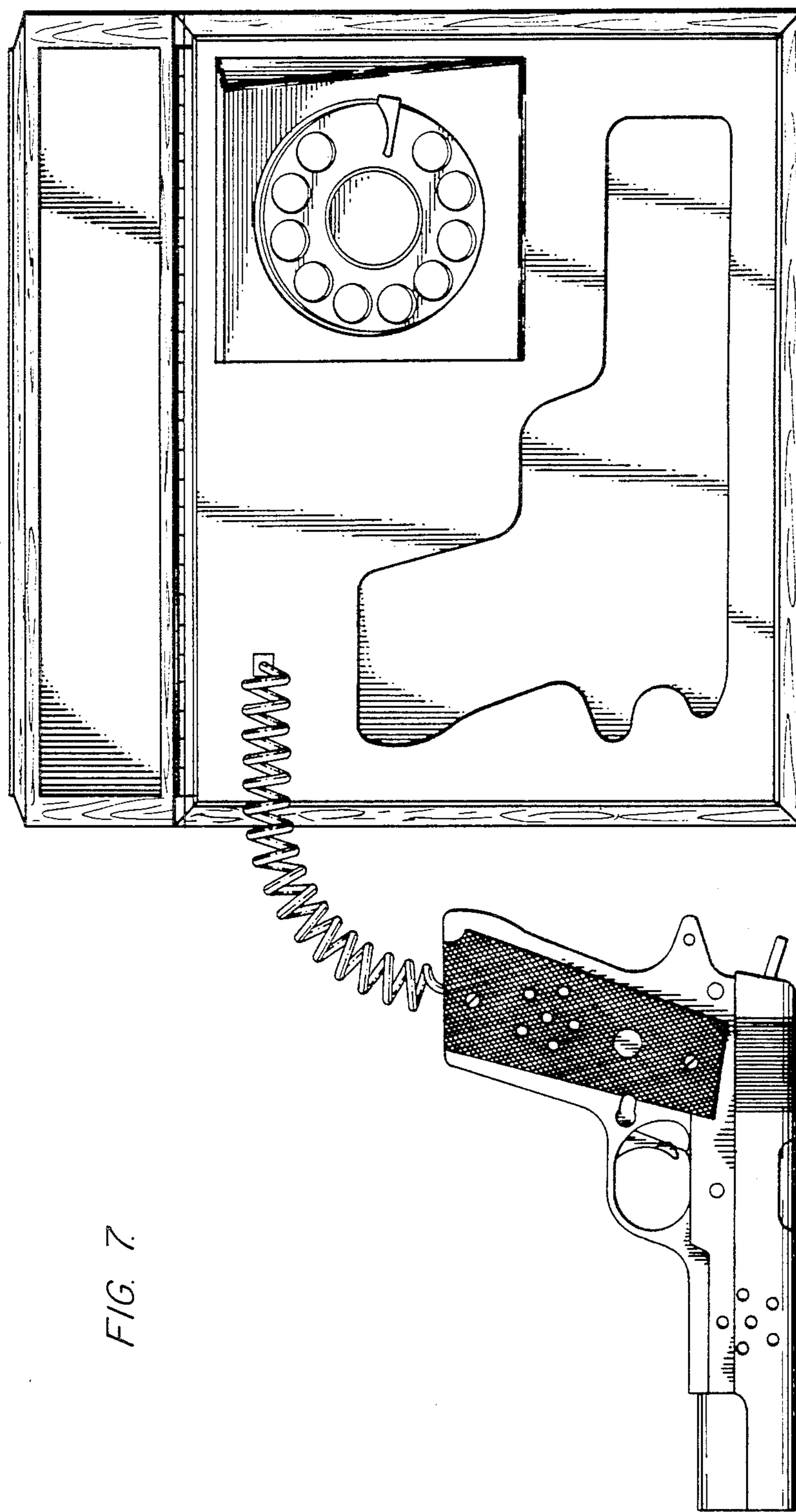

FIG. 7