

[54] PUNCH

[76] Inventor: Ruben J. Hartmeister, 1034 6th St., Golden, Colo. 80401

[\*\*] Term: 14 Years

[21] Appl. No.: 381,200

[22] Filed: May 24, 1982

[52] U.S. Cl. .... D8/52; D8/14; D8/98

[58] Field of Search ..... D8/51, 52, 386; 30/358, 30/368, 91.2; 29/243.53, 243.54, 34 R, 34 B, 34 D, 257; 59/7; 81/313, 415, 420, 9.5 R, 9.5 A, 9.5 B, 9.5 C; 72/409, 464

[56] References Cited

U.S. PATENT DOCUMENTS

311,121	1/1885	Hair	72/409	X
485,370	11/1892	Brooks	72/409	X
2,826,106	3/1958	Schegulla	72/409	X
3,059,511	10/1962	Morris	72/409	X
3,109,332	11/1963	Rando	81/9.5	R

3,156,087	11/1964	Granberg	29/243.54	X
3,703,840	11/1972	Kauf	81/9.5	R

FOREIGN PATENT DOCUMENTS

133509	11/1951	Sweden	30/91.1	
--------	---------	--------	---------	--

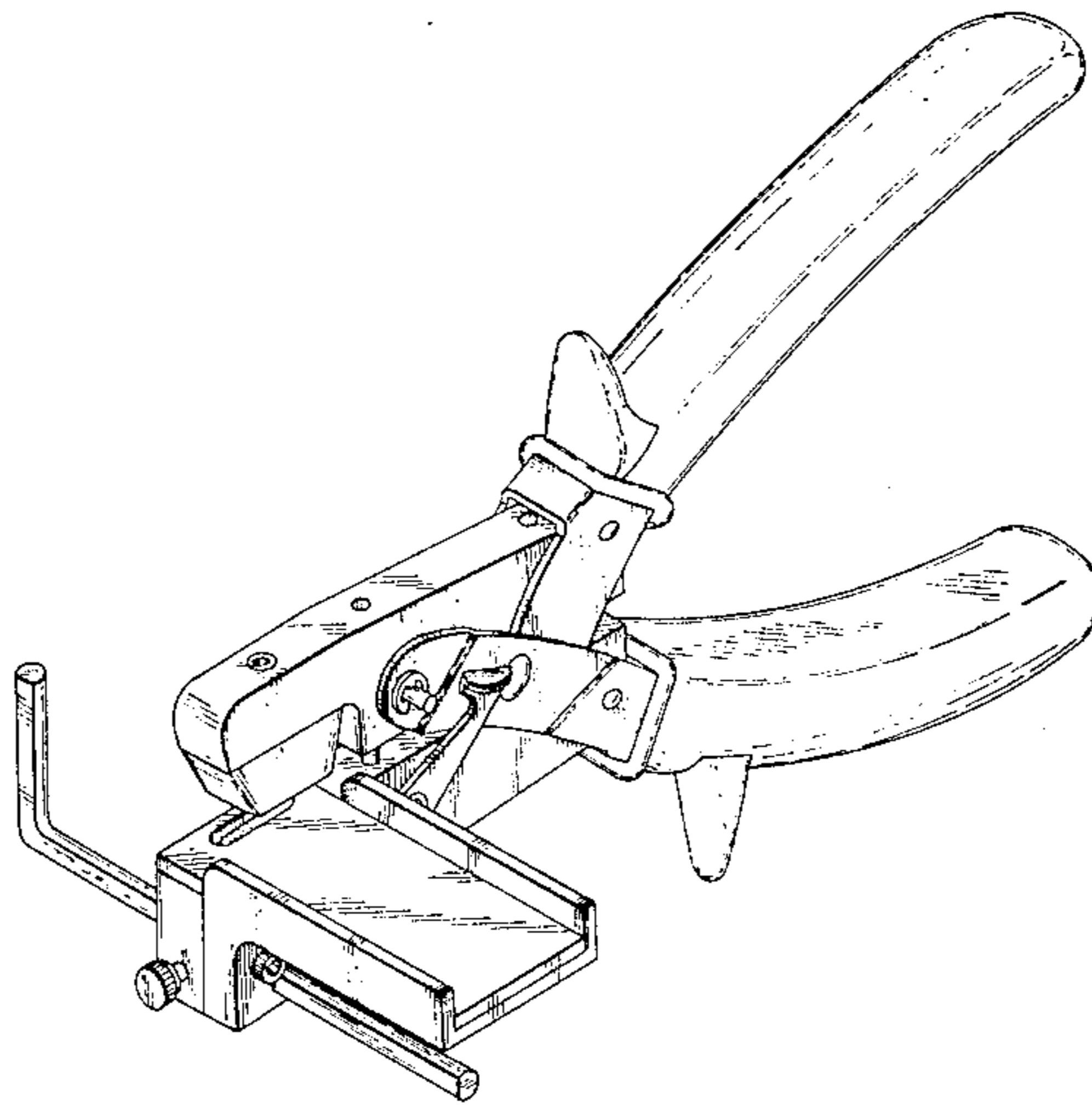
Primary Examiner—Susan J. Lucas  
Assistant Examiner—C. E. Heflin  
Attorney, Agent, or Firm—Kyle W. Rost

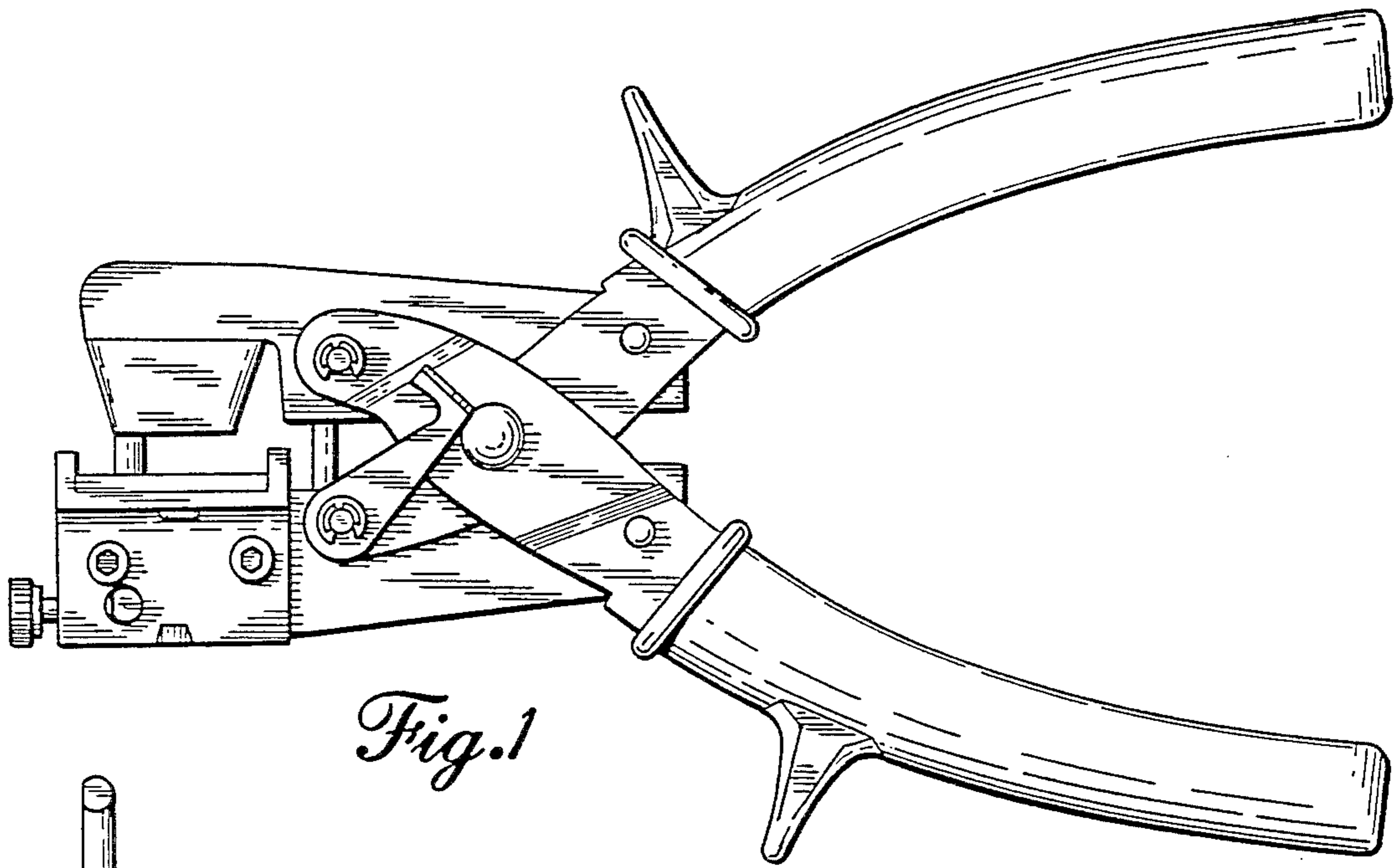
[57] CLAIM

The ornamental design for a punch, substantially as shown and described.

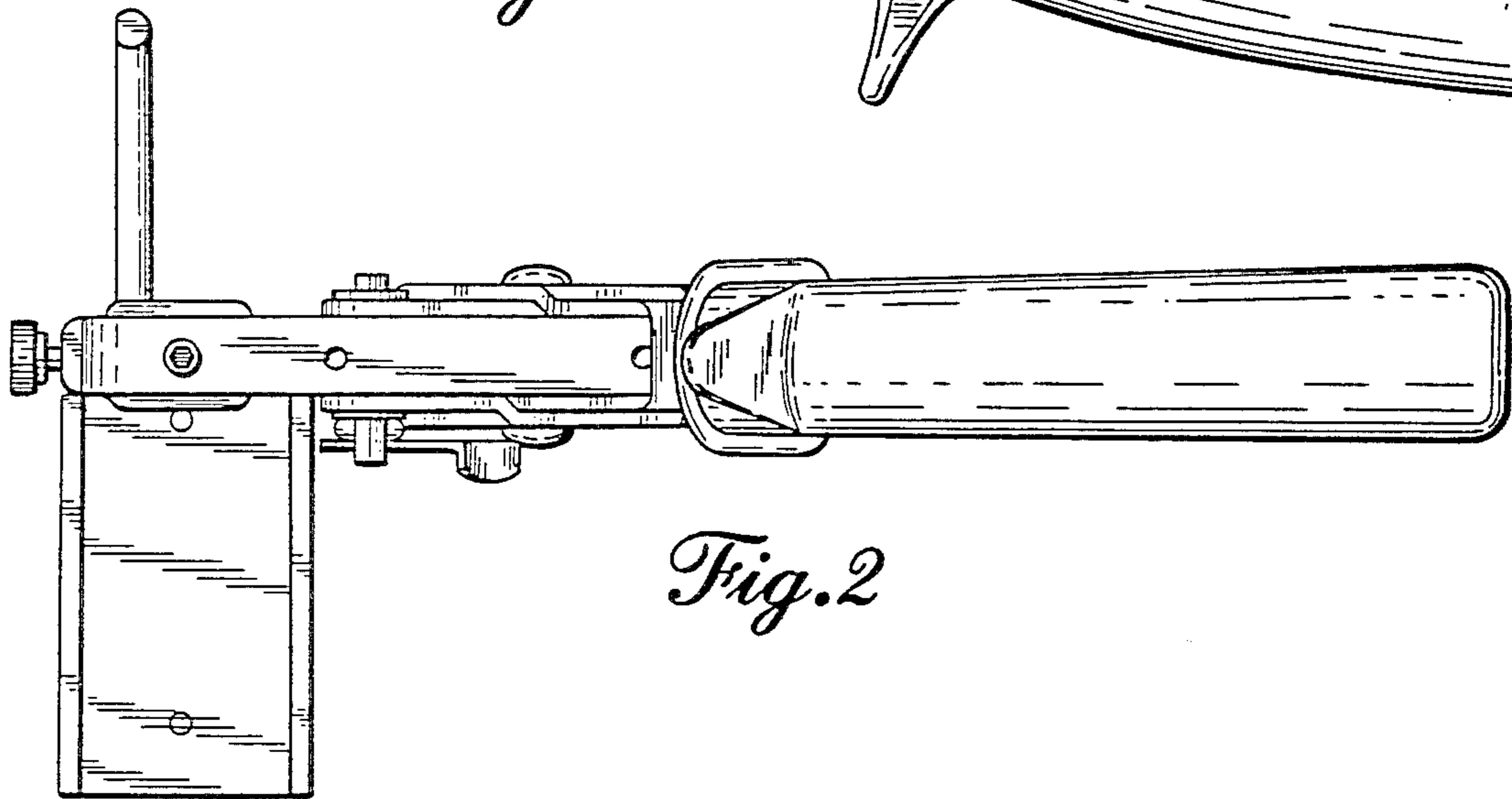
DESCRIPTION

FIG. 1 is a right side elevational view of the punch showing my new design;  
FIG. 2 is a top view thereof;  
FIG. 3 is a bottom view thereof;  
FIG. 4 is a left side elevational view thereof;  
FIG. 5 is a front view thereof;  
FIG. 6 is a rear view thereof;  
FIG. 7 is a right front perspective view thereof.

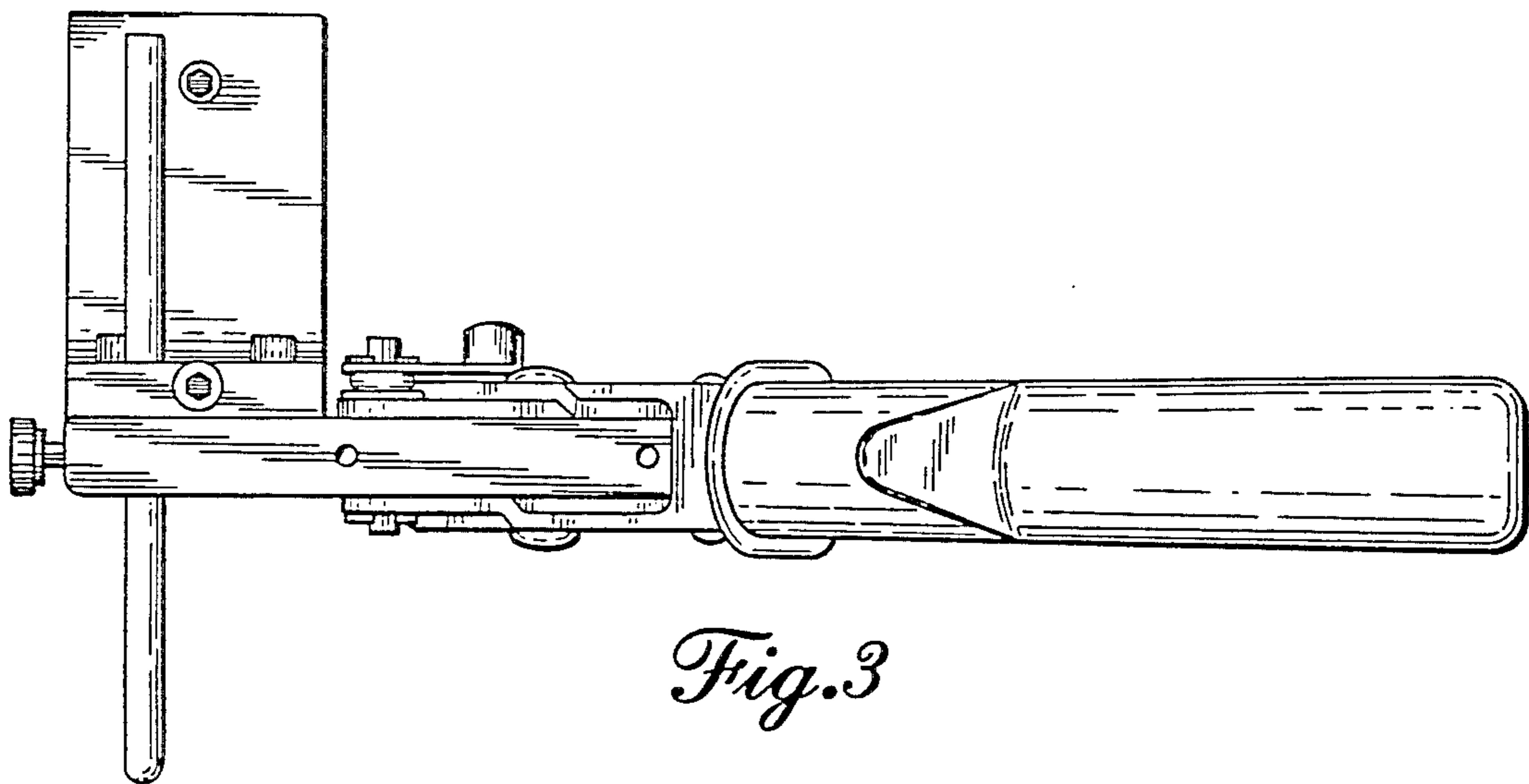




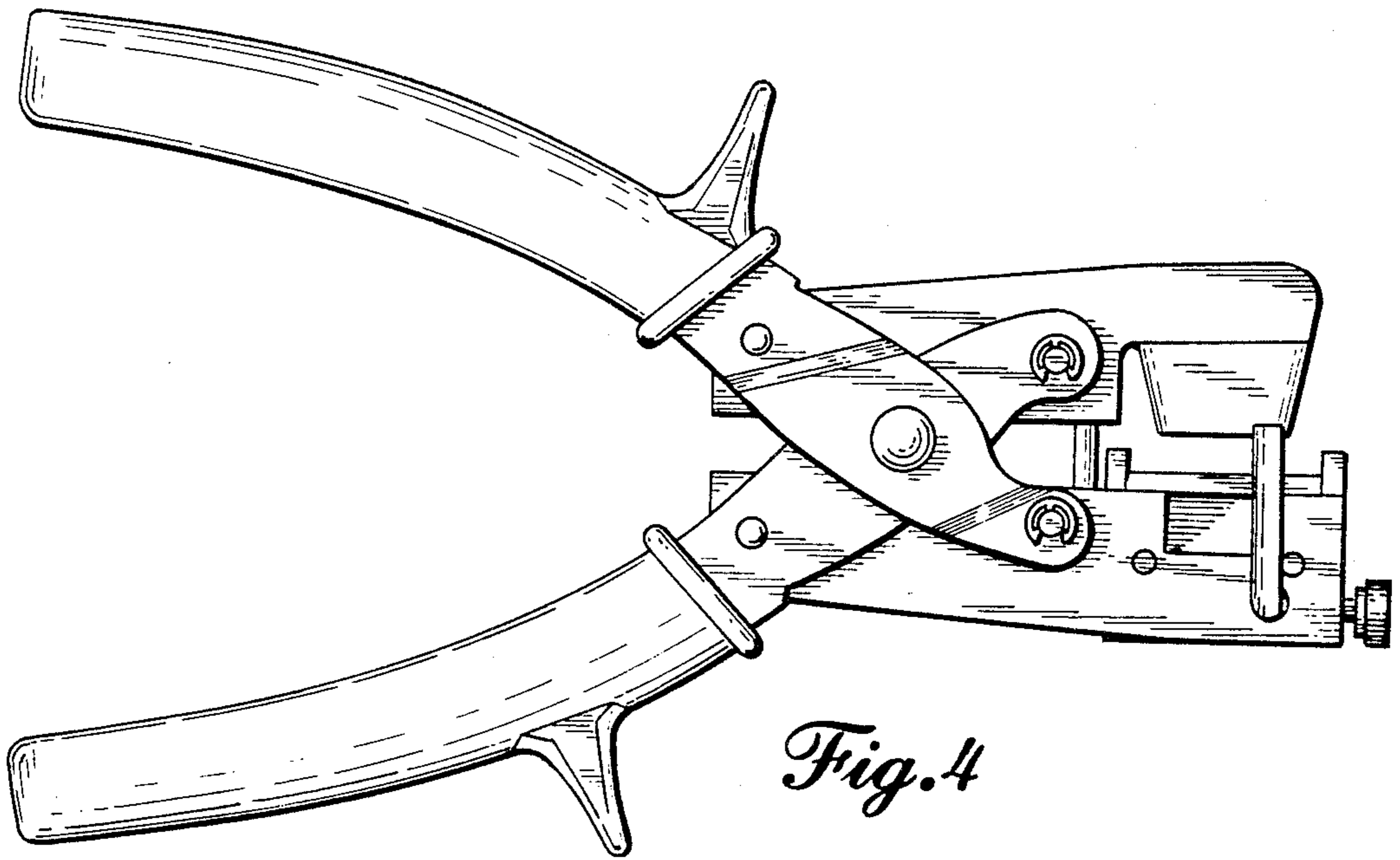
*Fig. 1*



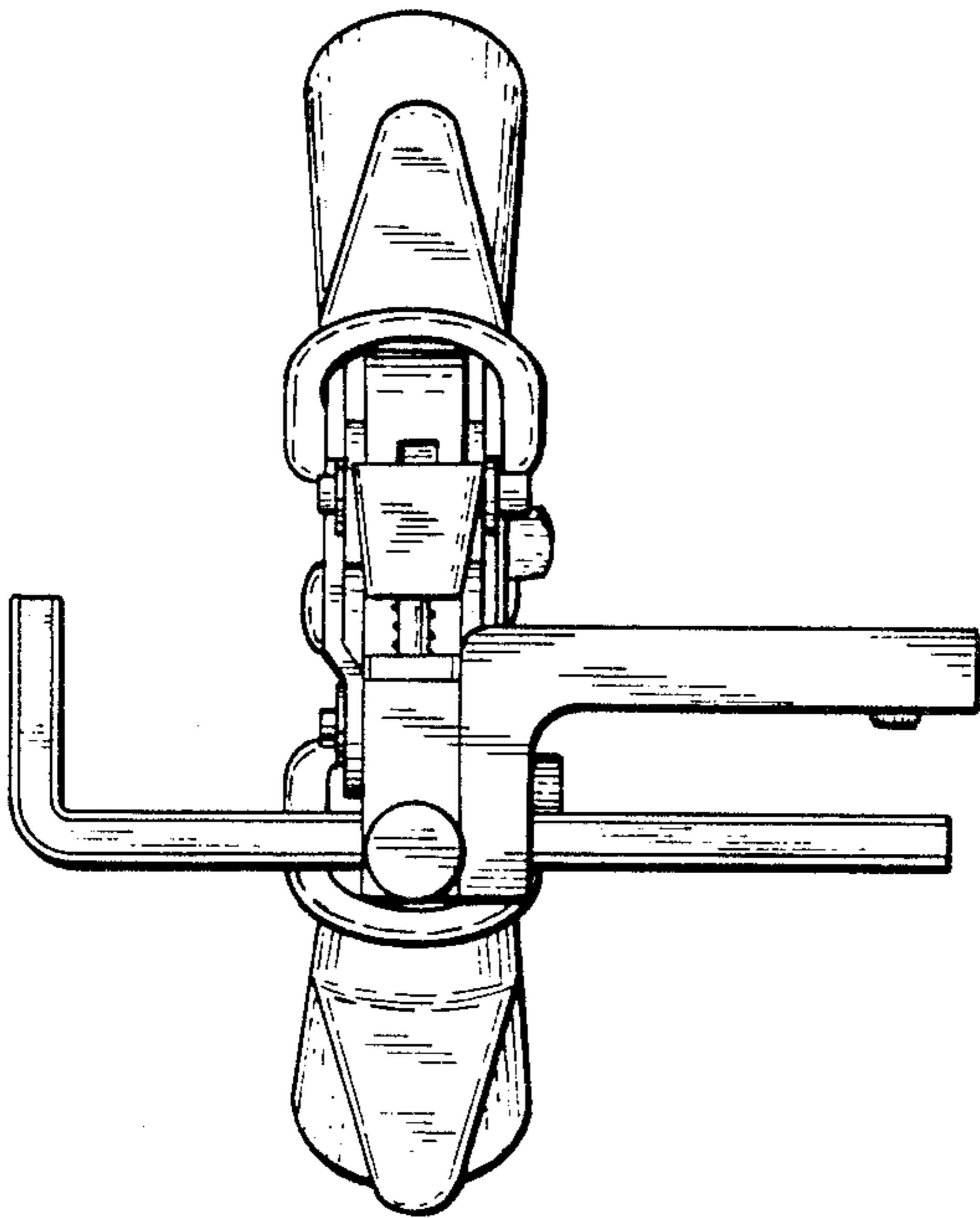
*Fig. 2*



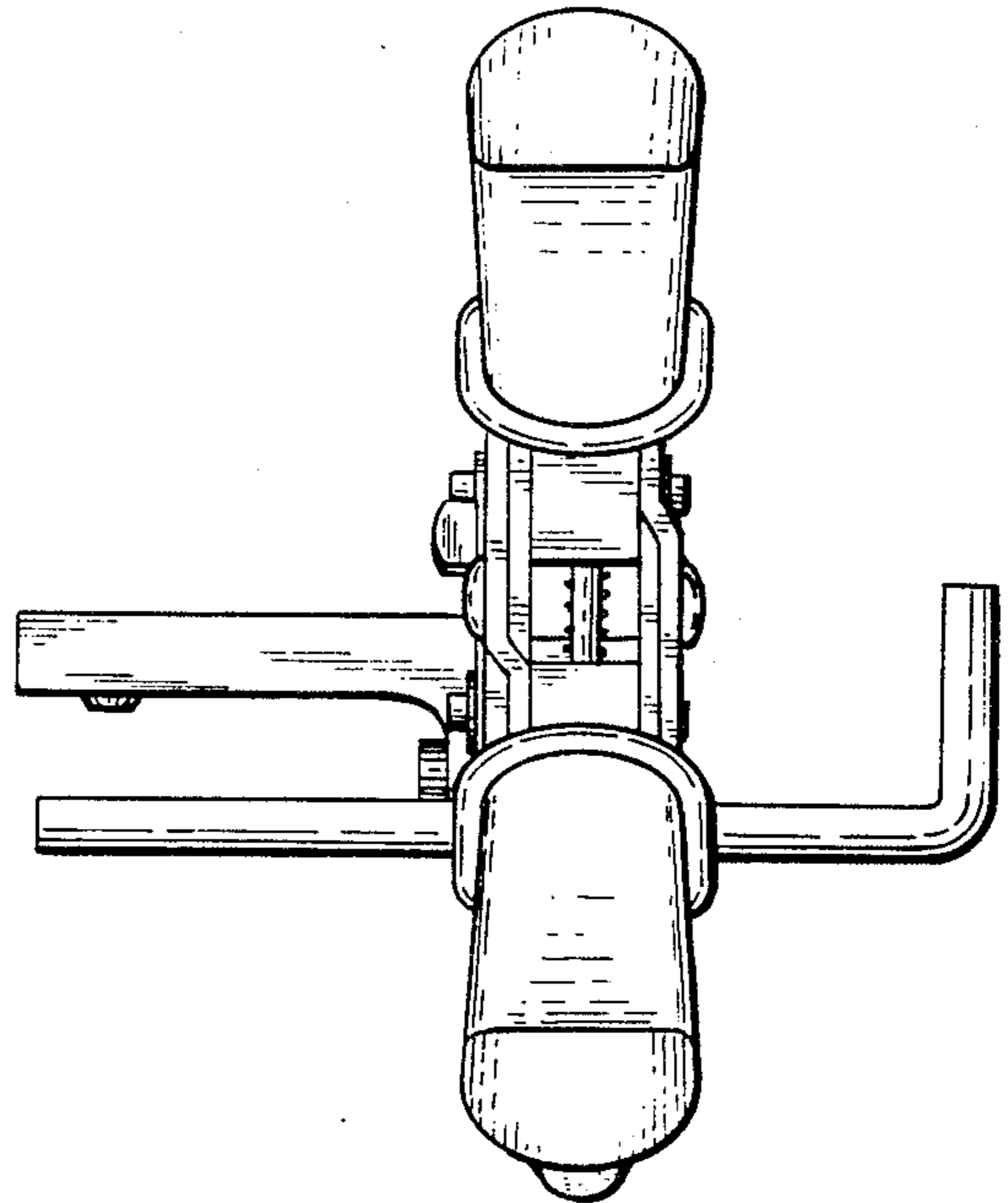
*Fig. 3*



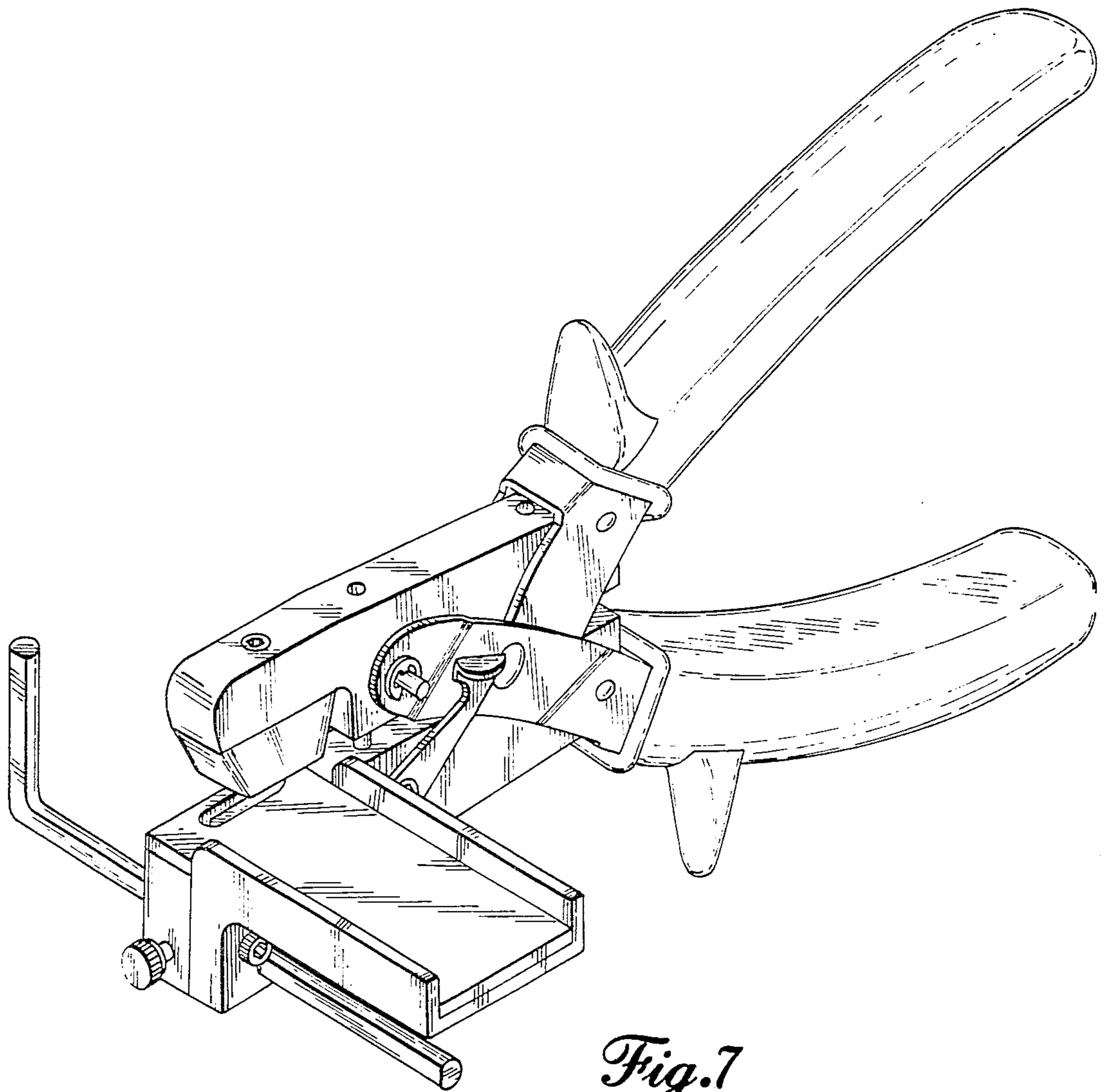
*Fig. 4*



*Fig. 5*



*Fig. 6*



*Fig. 7*