

[54] DUAL HAIR-FROSTING NEEDLE

[76] Inventor: Vincent L. Ramik, 4966 Sabra La., Annandale, Va. 22003

[\*\*] Term: 14 Years

[21] Appl. No.: 522,582

[22] Filed: Aug. 12, 1983

[52] U.S. Cl. .... D28/20; D3/28

[58] Field of Search ..... D28/7, 20, 99, 56-63; D3/18, 28; D19/43, 51; 66/118; 132/1 R, 7, 9, 73-76.5; D2/378.3

[56] References Cited

U.S. PATENT DOCUMENTS

- D. 259,523 6/1981 Hopper ..... D3/28
- D. 277,430 2/1985 Okada ..... D3/28

- 2,655,924 10/1953 Petitta ..... 132/9
- 2,779,991 2/1957 Bolick, Sr. .... 132/76.2

FOREIGN PATENT DOCUMENTS

- 273589 4/1930 Italy ..... 66/118
- 9408 6/1890 United Kingdom ..... 66/118

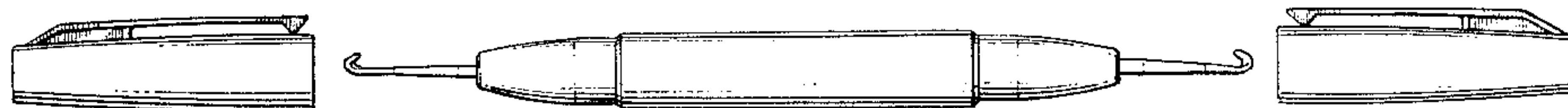
Primary Examiner—Louis S. Zarfes  
Attorney, Agent, or Firm—Diller, Ramik & Wight

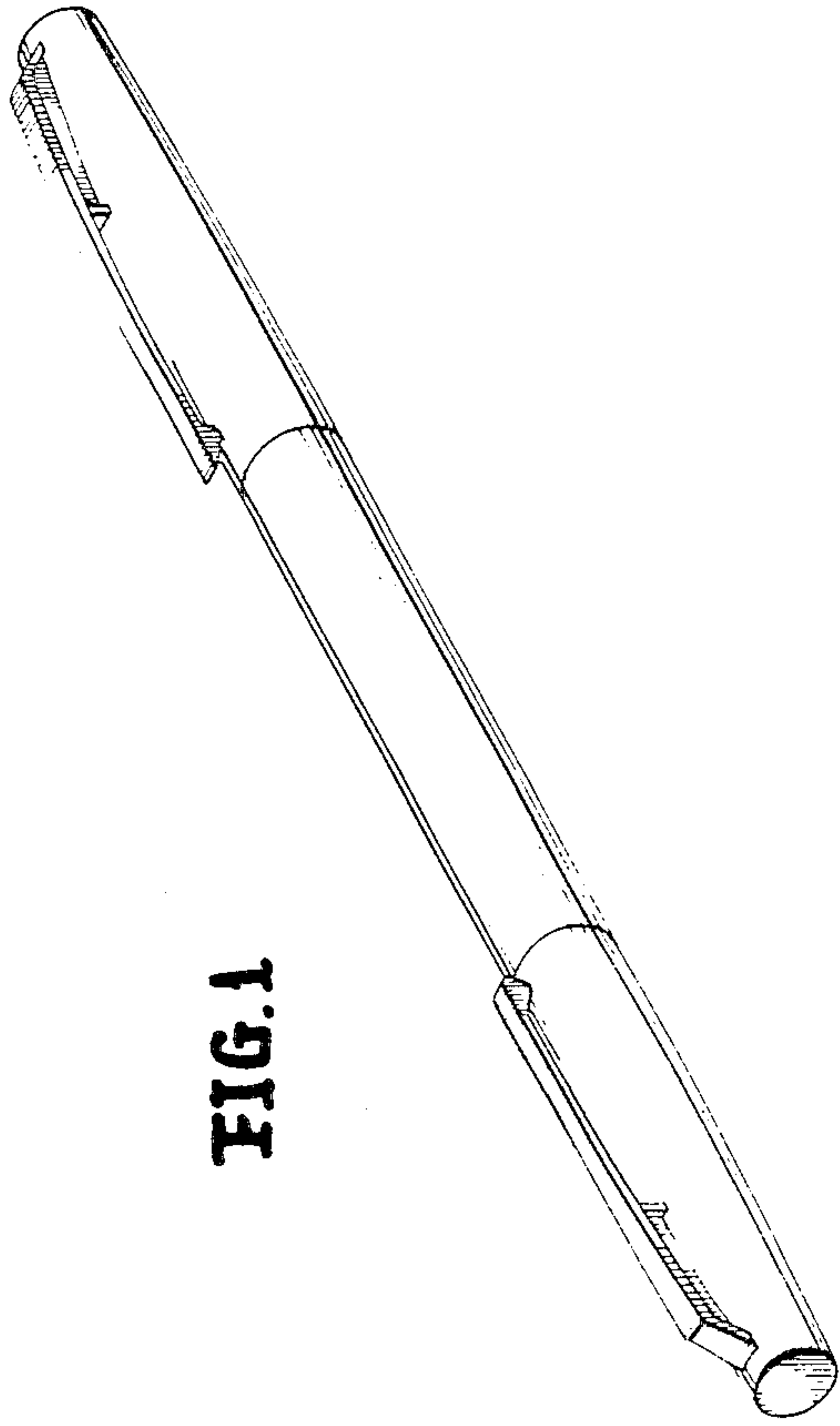
[57] CLAIM

The ornamental design for a dual hair-frosting needle, as shown and described.

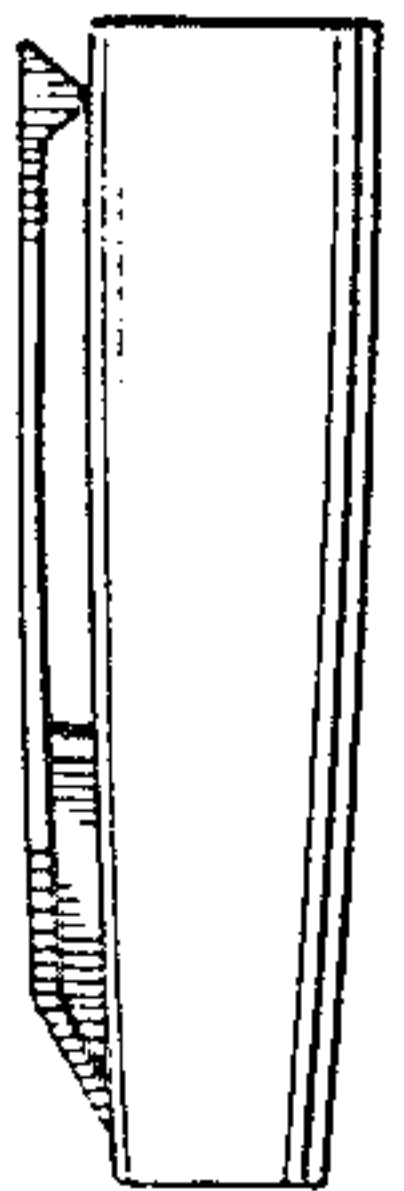
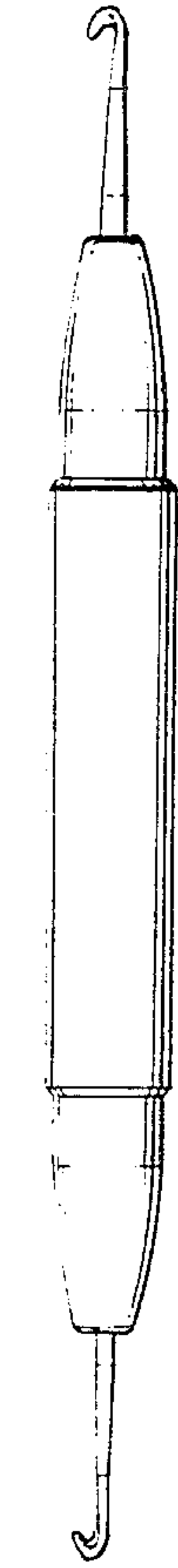
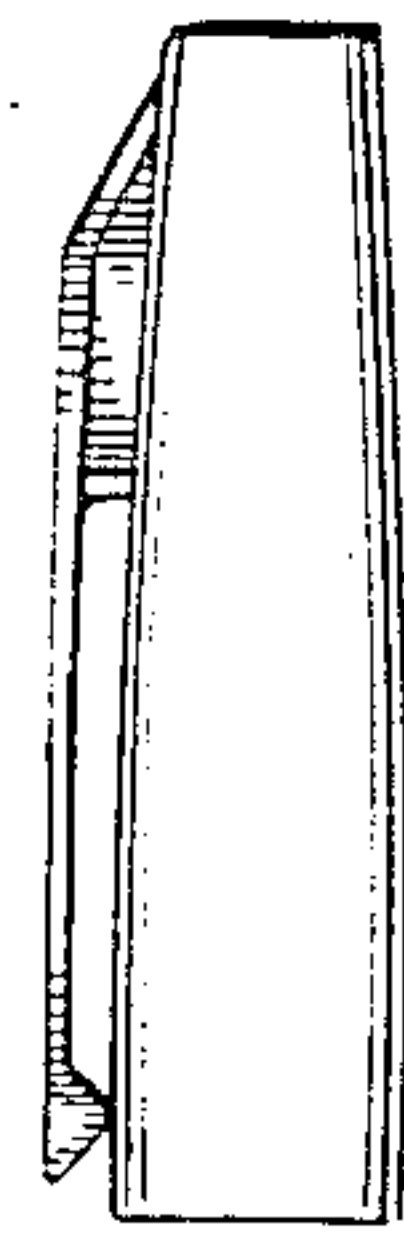
DESCRIPTION

FIG. 1 is a perspective view of a dual hair-frosting needle showing my new design; FIG. 2 is an exploded side elevational view thereof; and FIG. 3 is an exploded top plan view thereof.

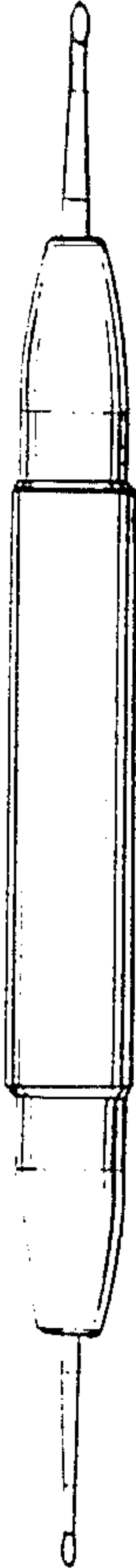
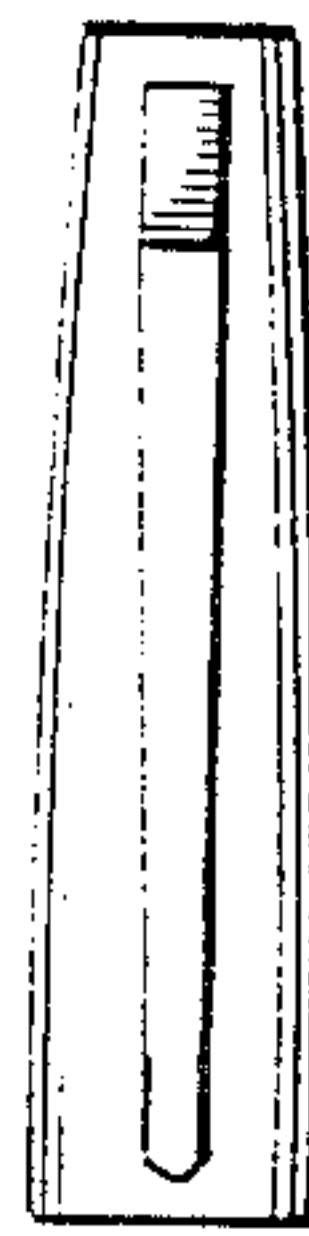




**FIG. 1**



**FIG. 2**



**FIG. 3**