

[54] **DENTAL SET FOR DENTAL MATERIALS**

DESCRIPTION

[75] **Inventor:** Alexander Neumeister, Munich, Fed. Rep. of Germany

FIG. 1 is a top left front perspective view of a dental set for dental materials, showing my new design and shown with the cover opened;

[73] **Assignee:** ESPE Fabrik pharmazeutischer Praeparate GmbH, Fed. Rep. of Germany

FIG. 2 is a front view of the new design with the cover opened;

[**] **Term:** 14 Years

FIG. 3 is a front view similar to FIG. 2, viewed from somewhat further up, with the cover omitted;

[21] **Appl. No.:** 506,795

FIG. 4 is a representation similar to FIG. 3, the left one of the fittings arranged in the set being swivelled upwards into an inclined position;

[22] **Filed:** Jun. 22, 1983

FIG. 5 is a view of the new design similar to FIG. 1, without cover;

[30] **Foreign Application Priority Data**

Dec. 22, 1982 [DE] Fed. Rep. of Germany 11 AR 4325/82

FIG. 6 is a perspective front view from the upper right side of the new design with the cover omitted;

[52] **U.S. Cl.** D24/10; D24/31; D24/8

FIG. 7 is a view of the new design with the cover omitted, seen from the upper right side;

[58] **Field of Search** D24/8, 10-16, D24/29, 31, 32; D3/73, 74; D9/341, 337; 206/568, 570, 572, 368, 365, 83, 63.5; 433/77

FIG. 8 is a view of the new design with the cover omitted, seen from the upper left side;

[56] **References Cited**

U.S. PATENT DOCUMENTS

D. 248,109	6/1978	Ball	D24/31
D. 258,118	2/1981	Porteous	D24/10 X
2,159,904	5/1939	McDonough	206/570 X
2,219,597	10/1940	Lutz	206/572 X
4,180,159	12/1979	Tanaka	206/63.5
4,293,074	10/1981	Dunsky	206/369 X
4,294,349	10/1981	Ibsen et al.	206/63.5
4,353,694	10/1982	Pelerin	206/369 X

FIG. 9 is a view of the new design with the cover closed, viewed from the front and above;

FIG. 10 is a representation of the new design with the cover closed, viewed from the upper left side;

FIG. 11 is a representation of the new design with the cover closed, viewed from the upper right side;

FIG. 12 is a top plan view of the new design;

FIG. 13 is a view of the new design with the cover closed, seen from the upper rear side;

FIG. 14 is a perspective view showing the fitting of the new design without the casing in a front angle view, from the upper right side;

FIG. 15 is a perspective view of the fitting of the new design in a front angle view, from the upper left side;

FIG. 16 is a front view from an elevated point of the fitting of the new design;

FIG. 17 is a front view from an elevated point of the fitting in its backwardly inclined position.

Primary Examiner—Catherine E. Kemper
Attorney, Agent, or Firm—Barnes & Thornburg

[57] **CLAIM**

The ornamental design for a dental set for dental materials, as shown and described.

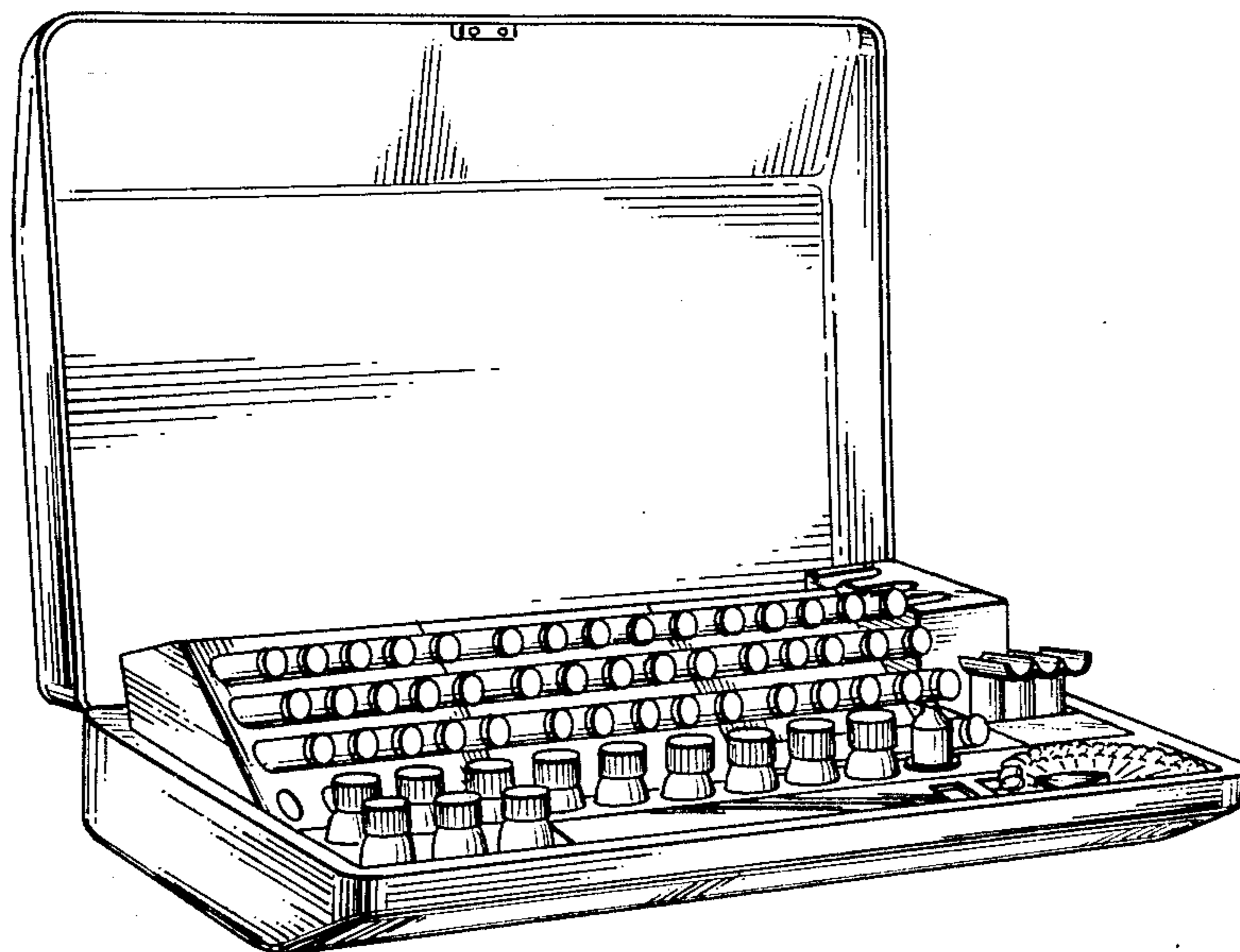

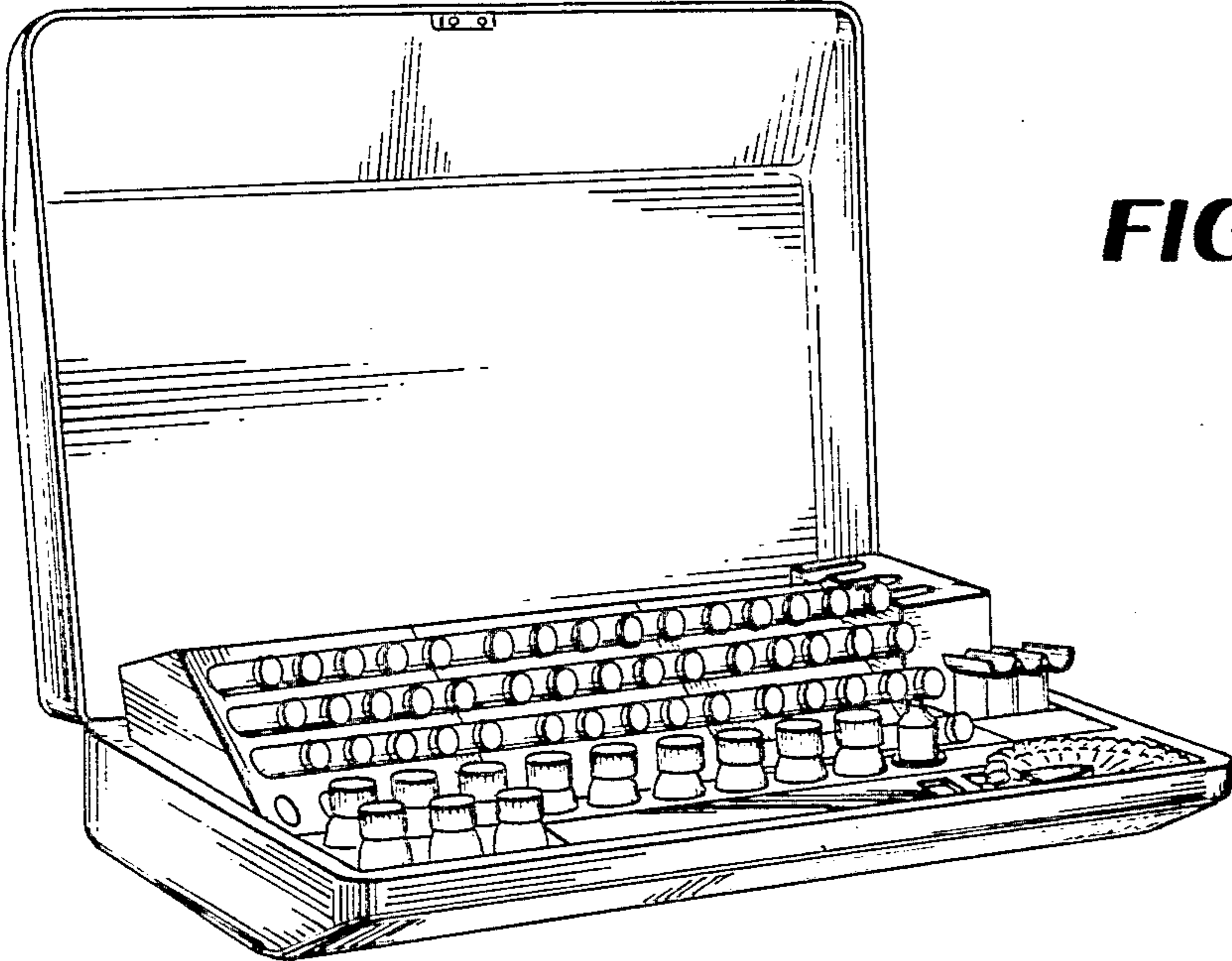

FIG. 1

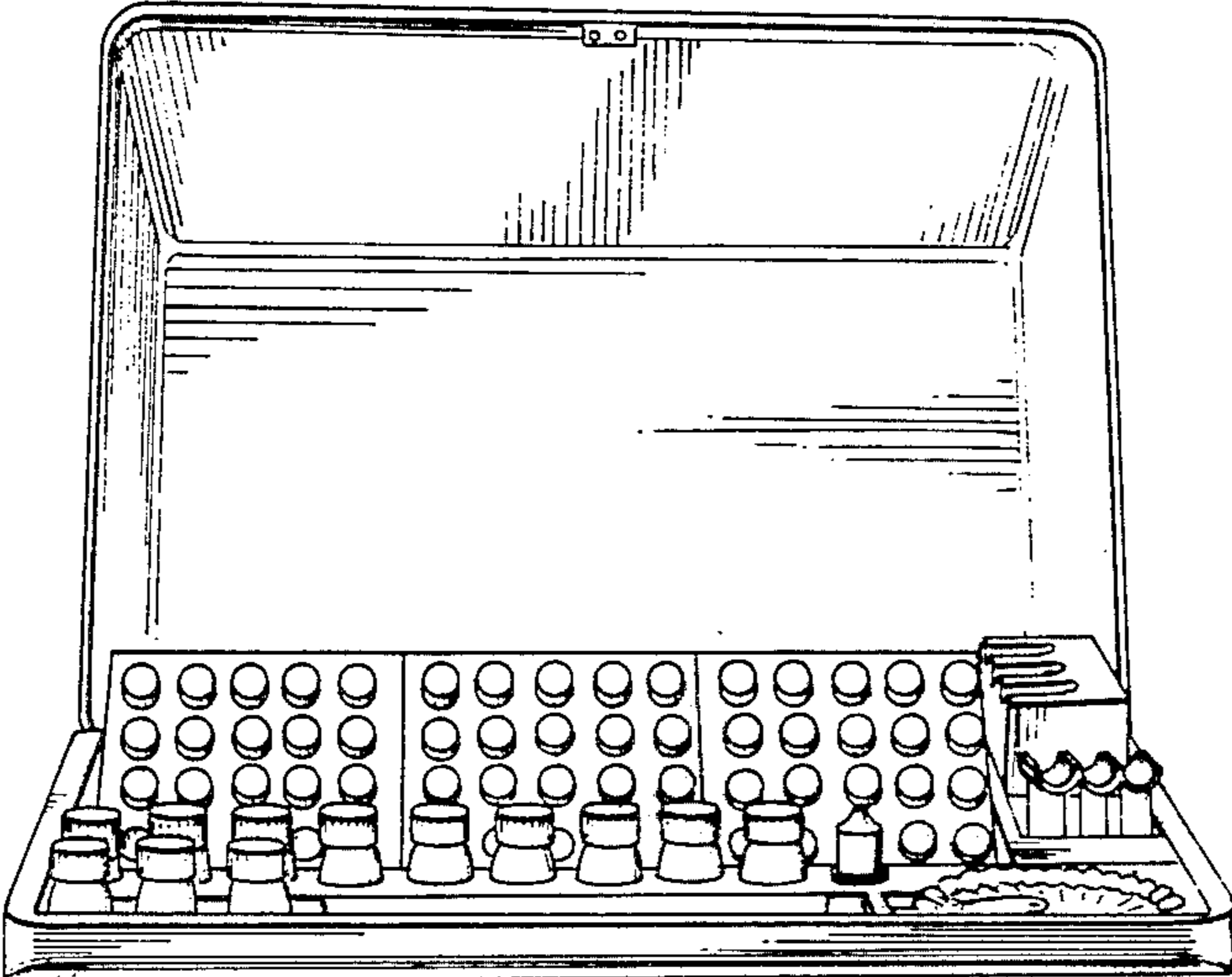

FIG. 2

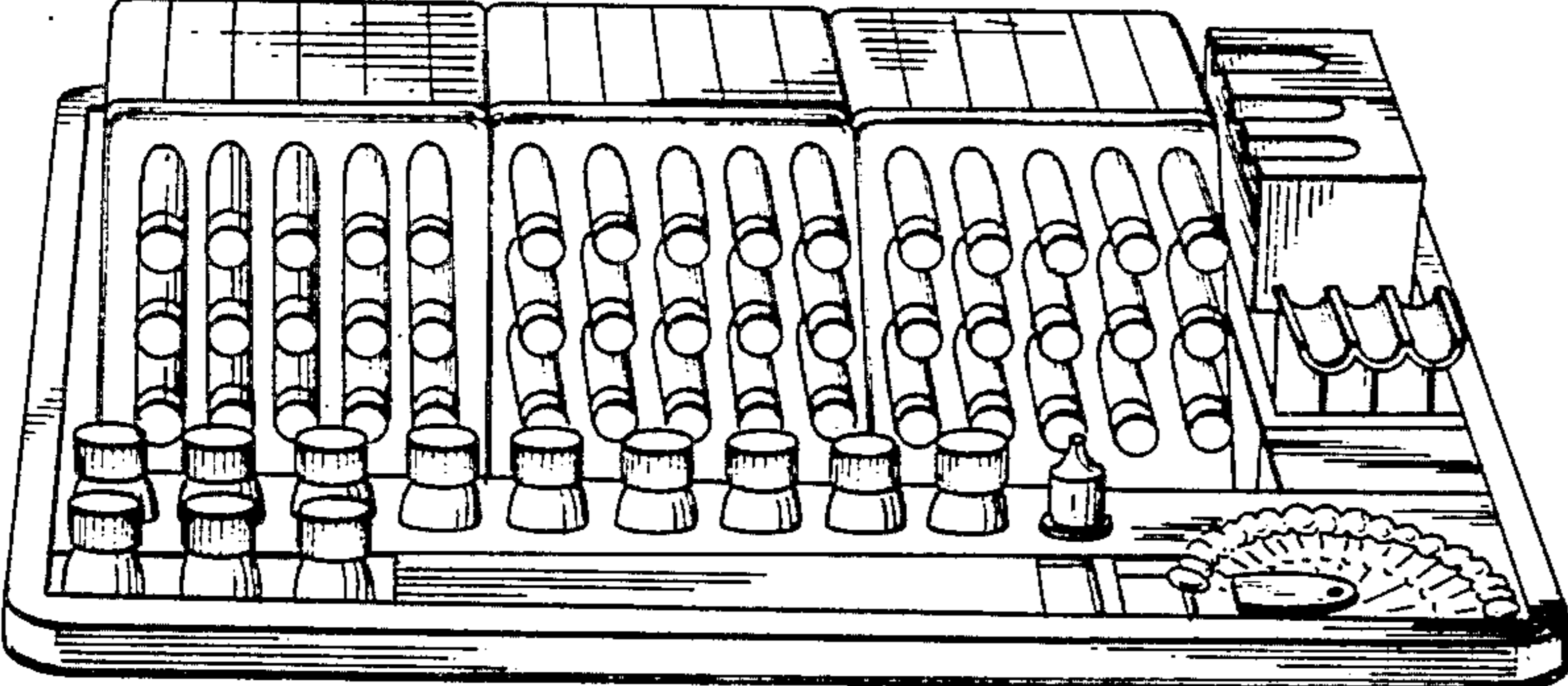

FIG. 3

FIG. 4

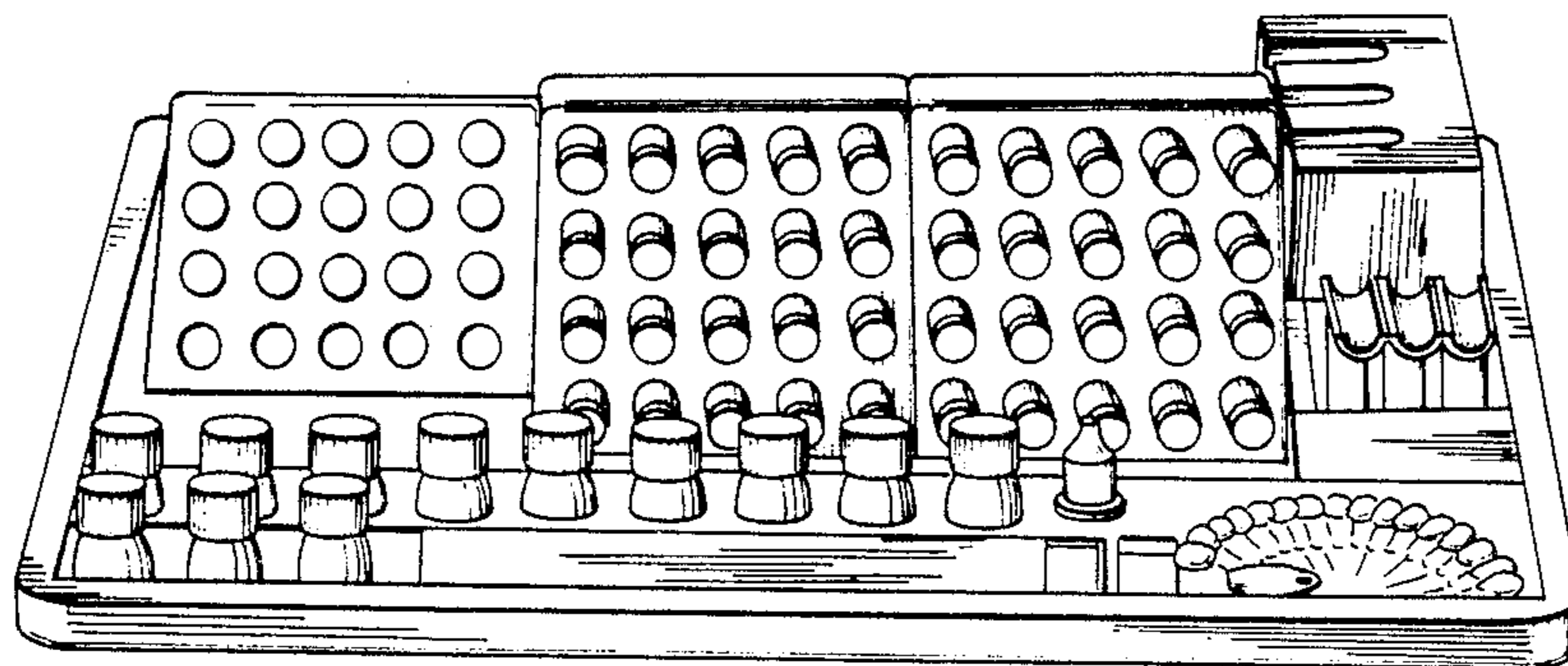

FIG. 5

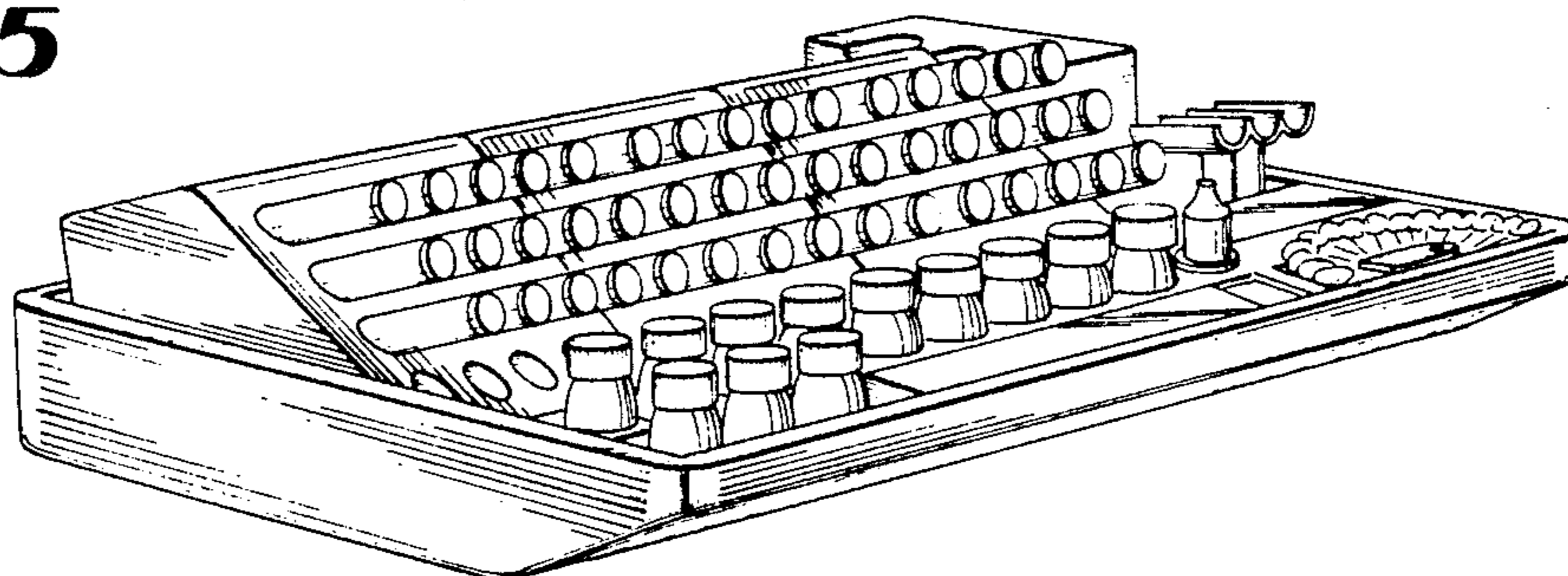

FIG. 6

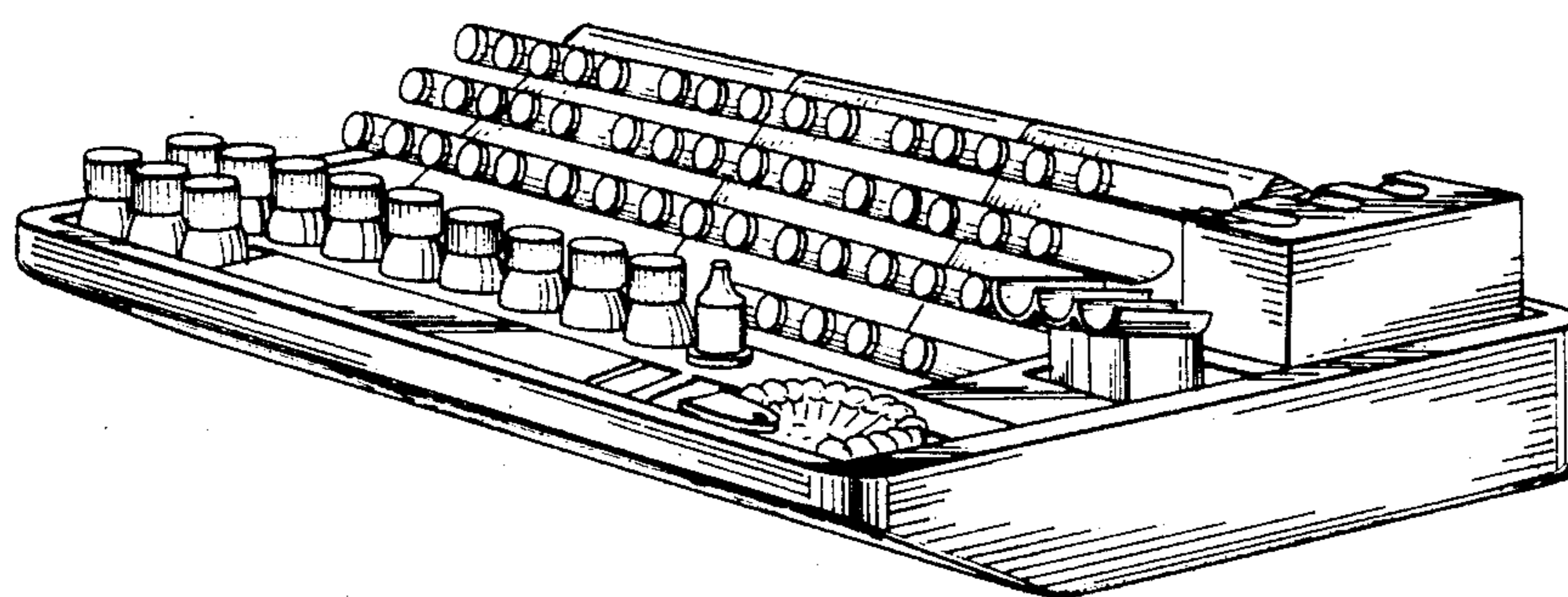

FIG. 7

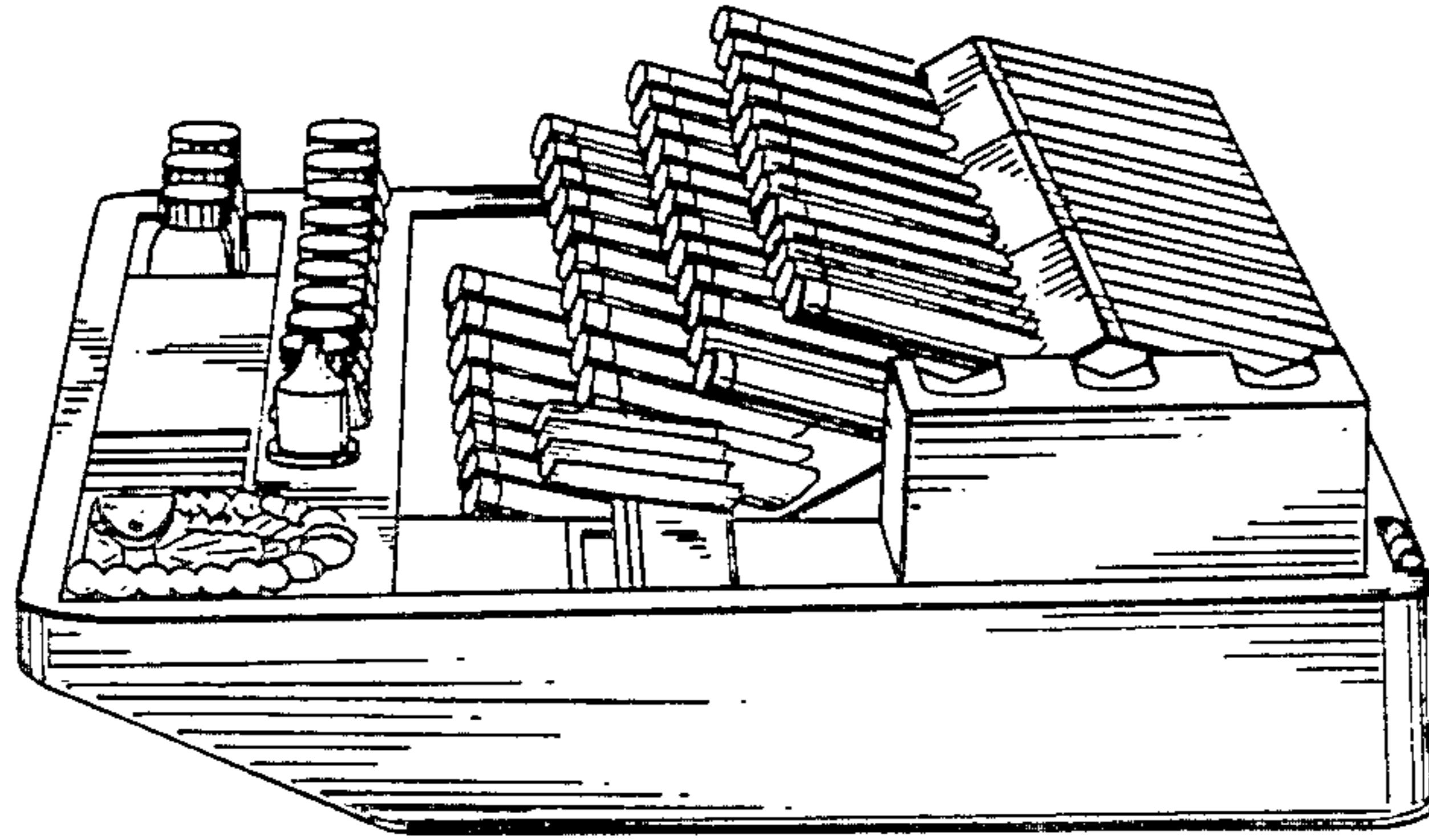

FIG. 8

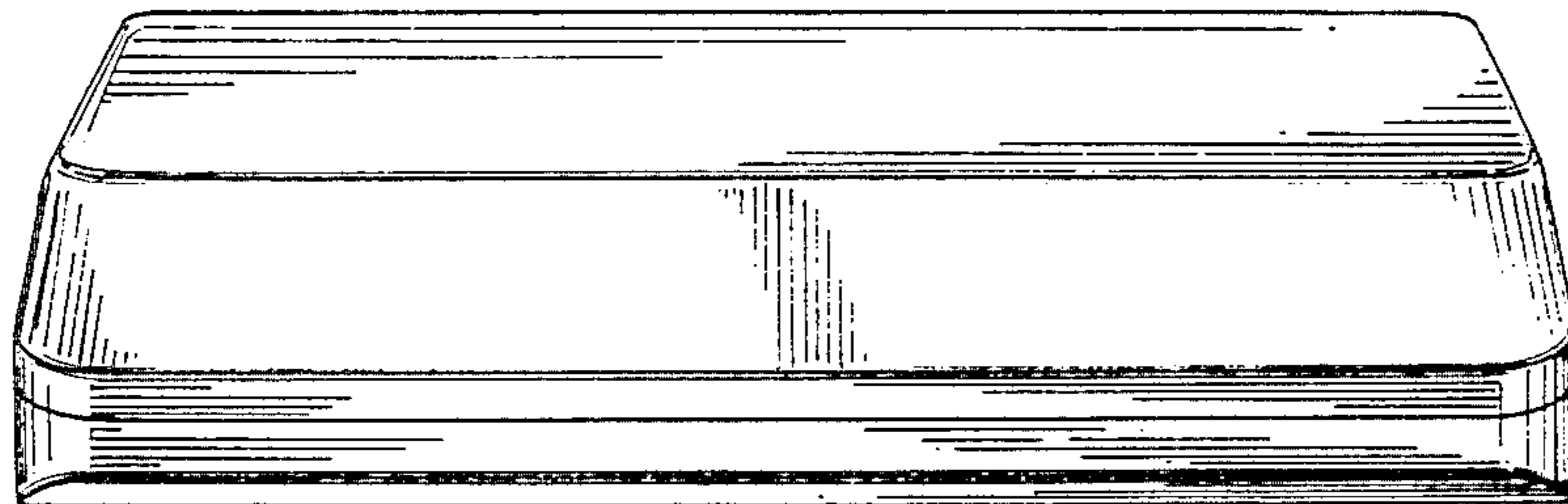
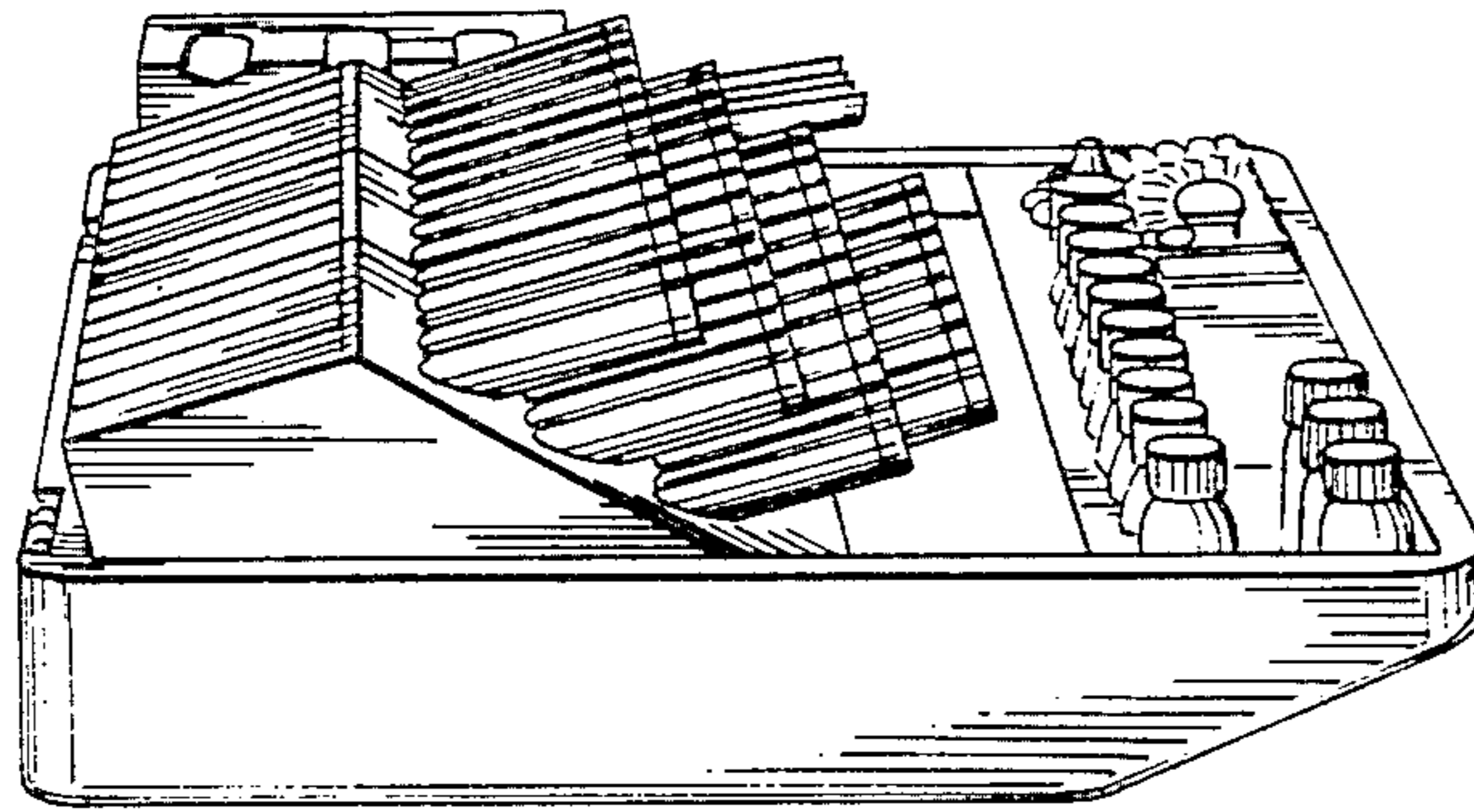

FIG. 9

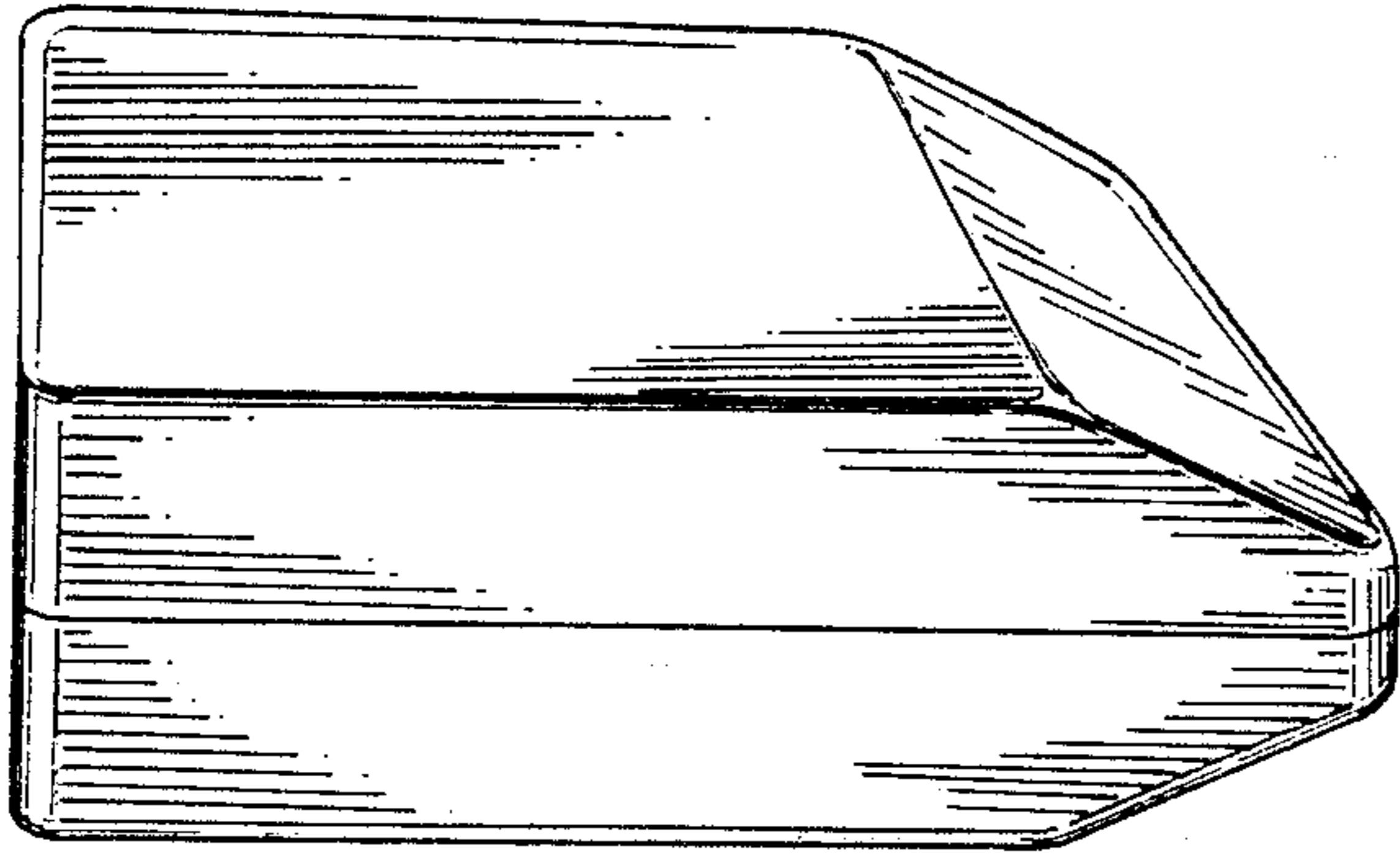

FIG. 10

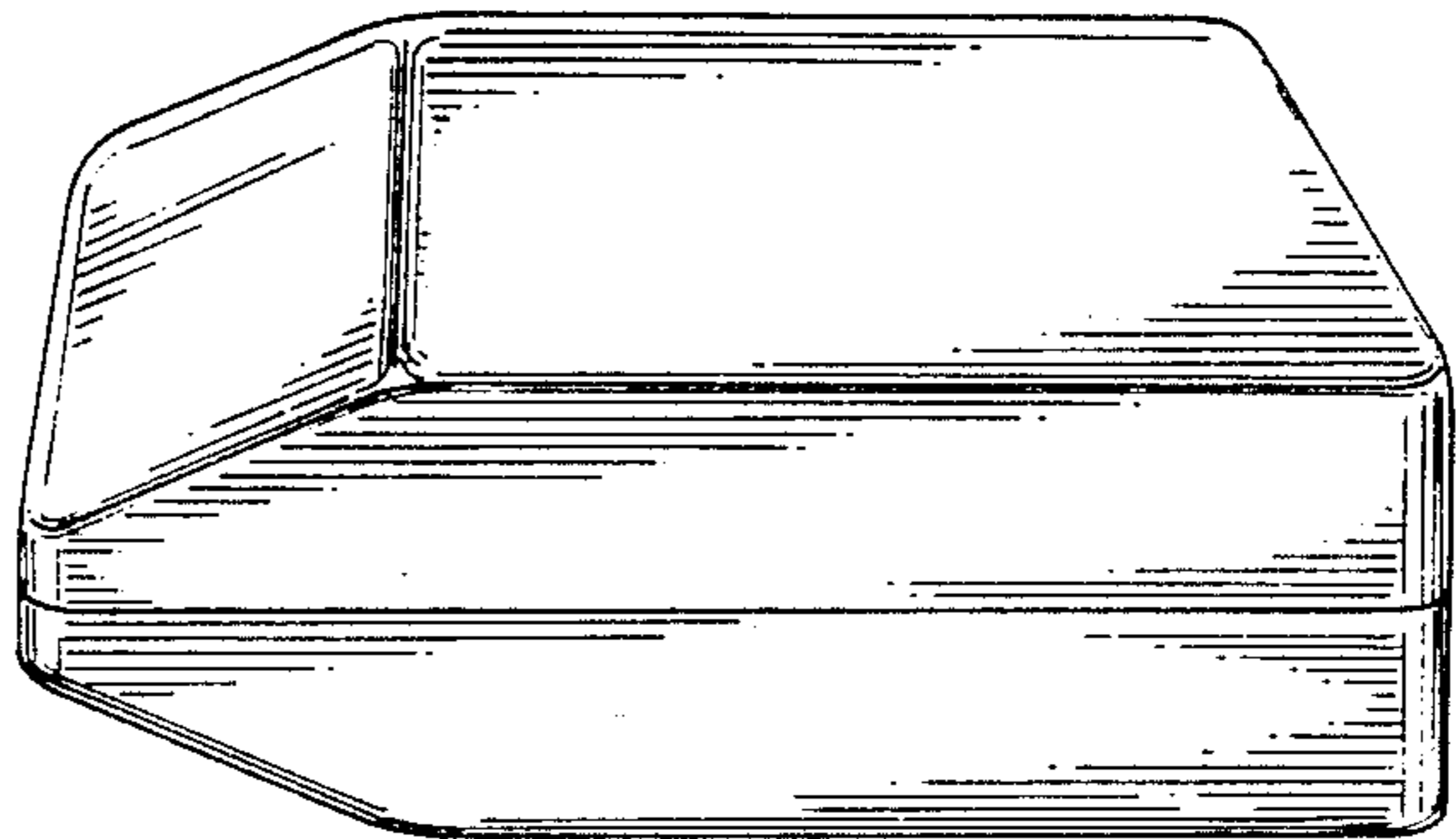

FIG. 11

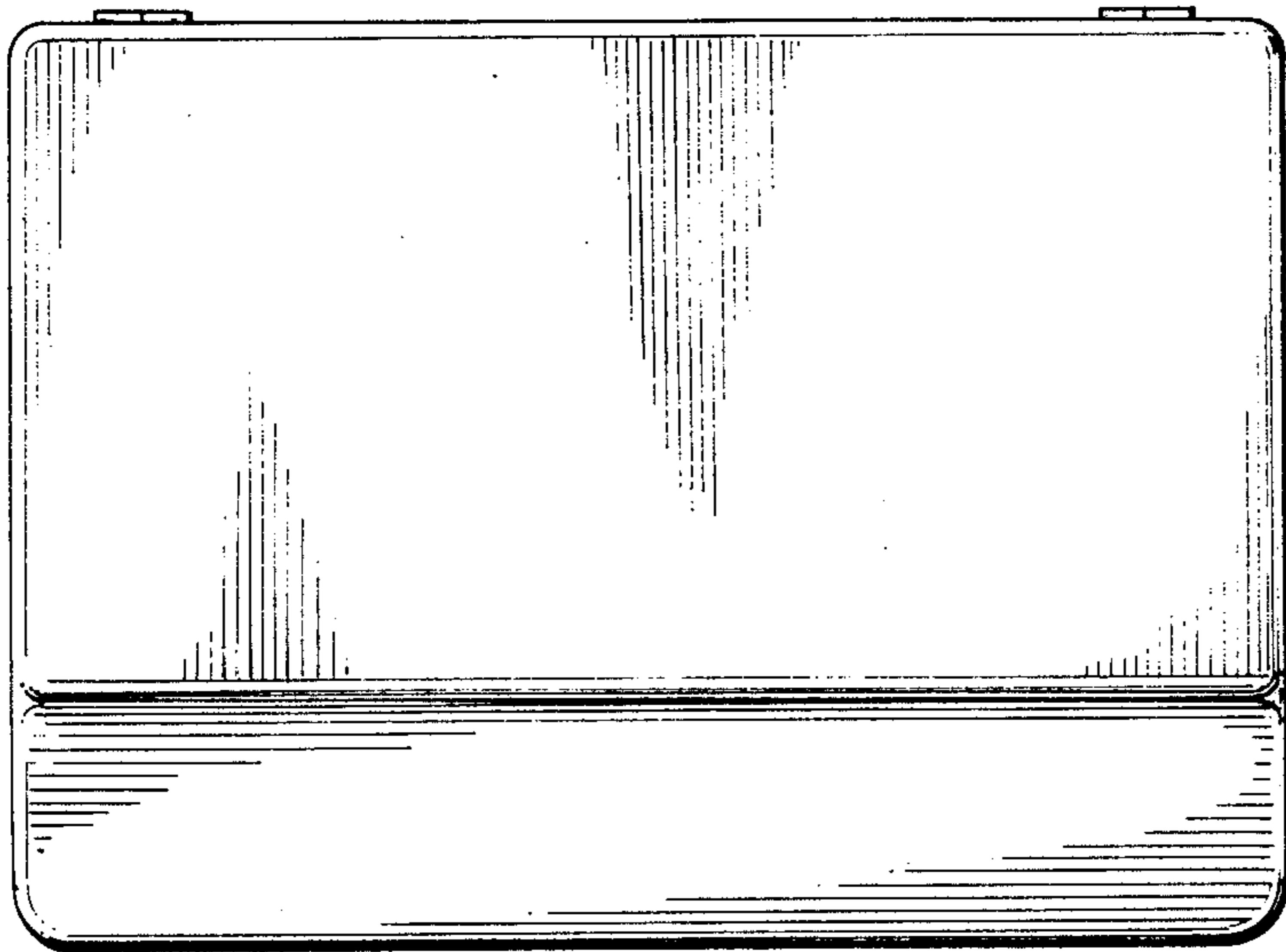

FIG. 12

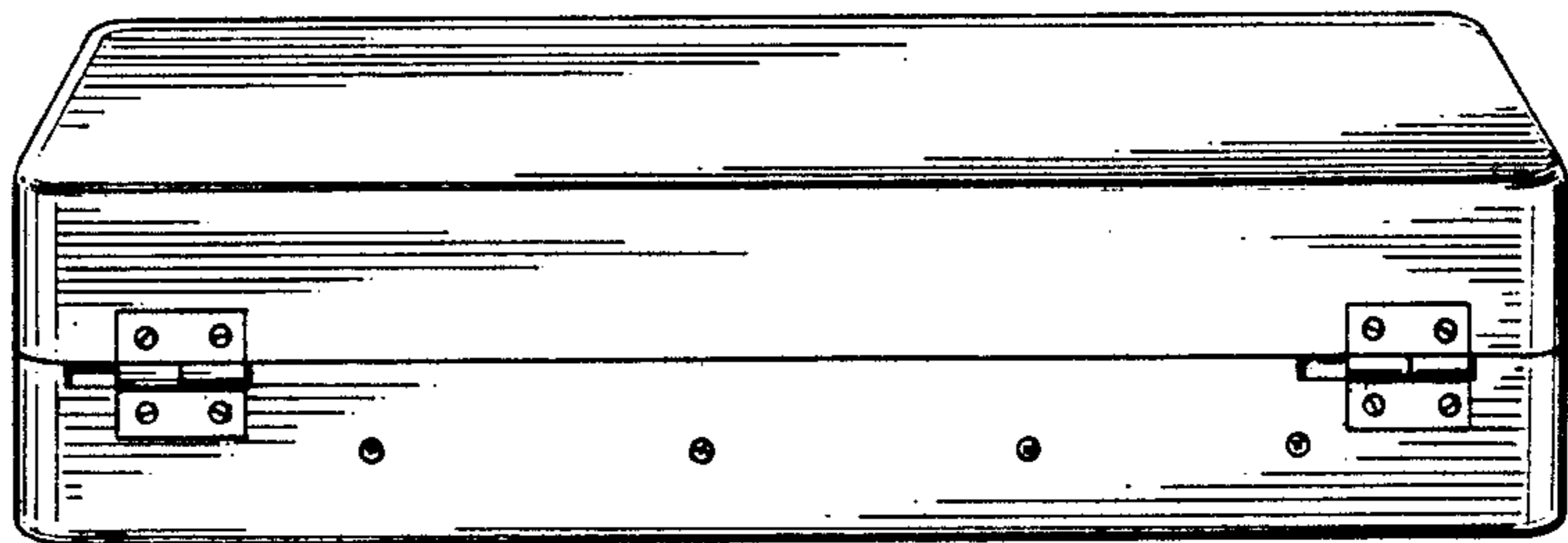

FIG. 13

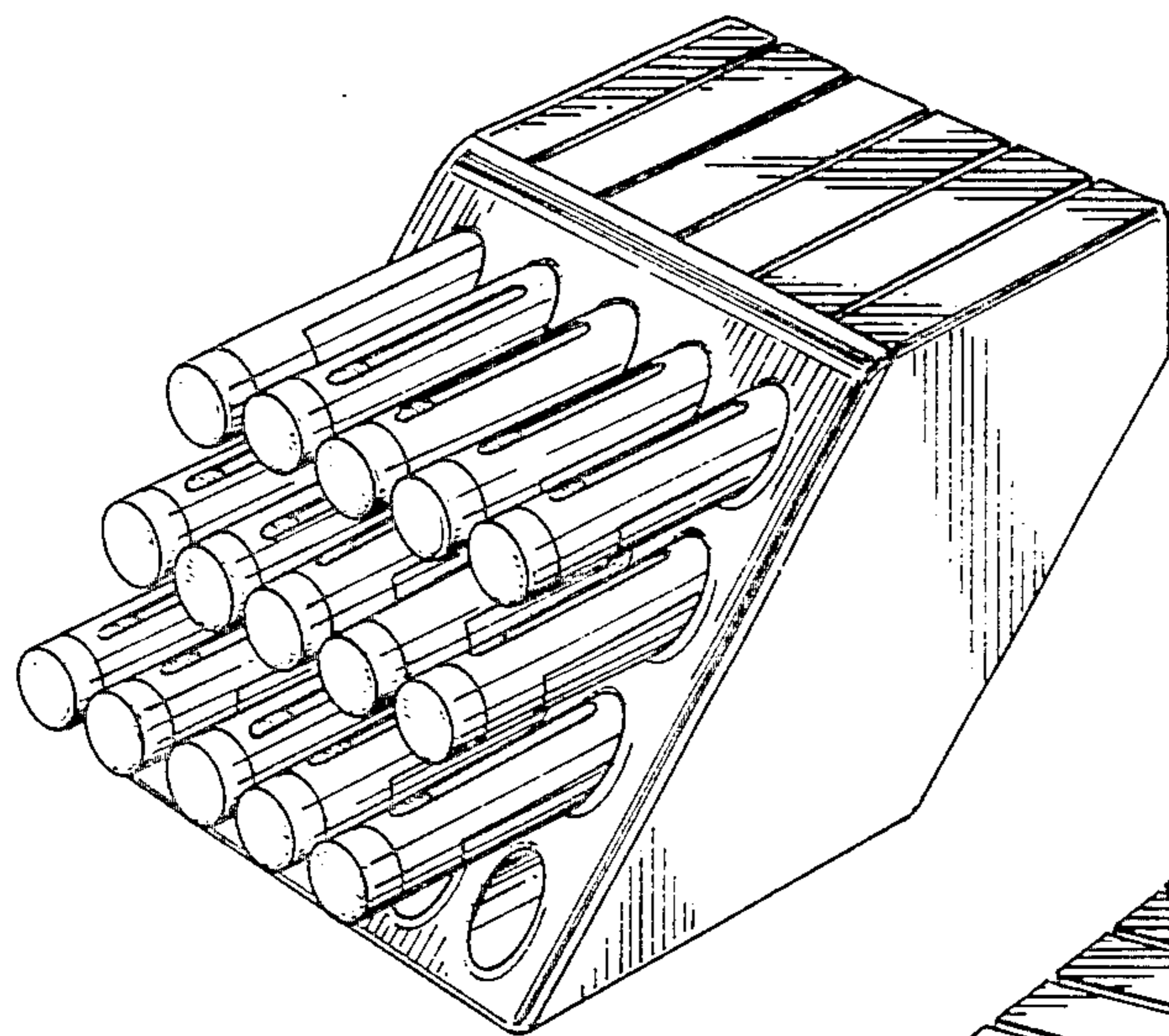

FIG. 14

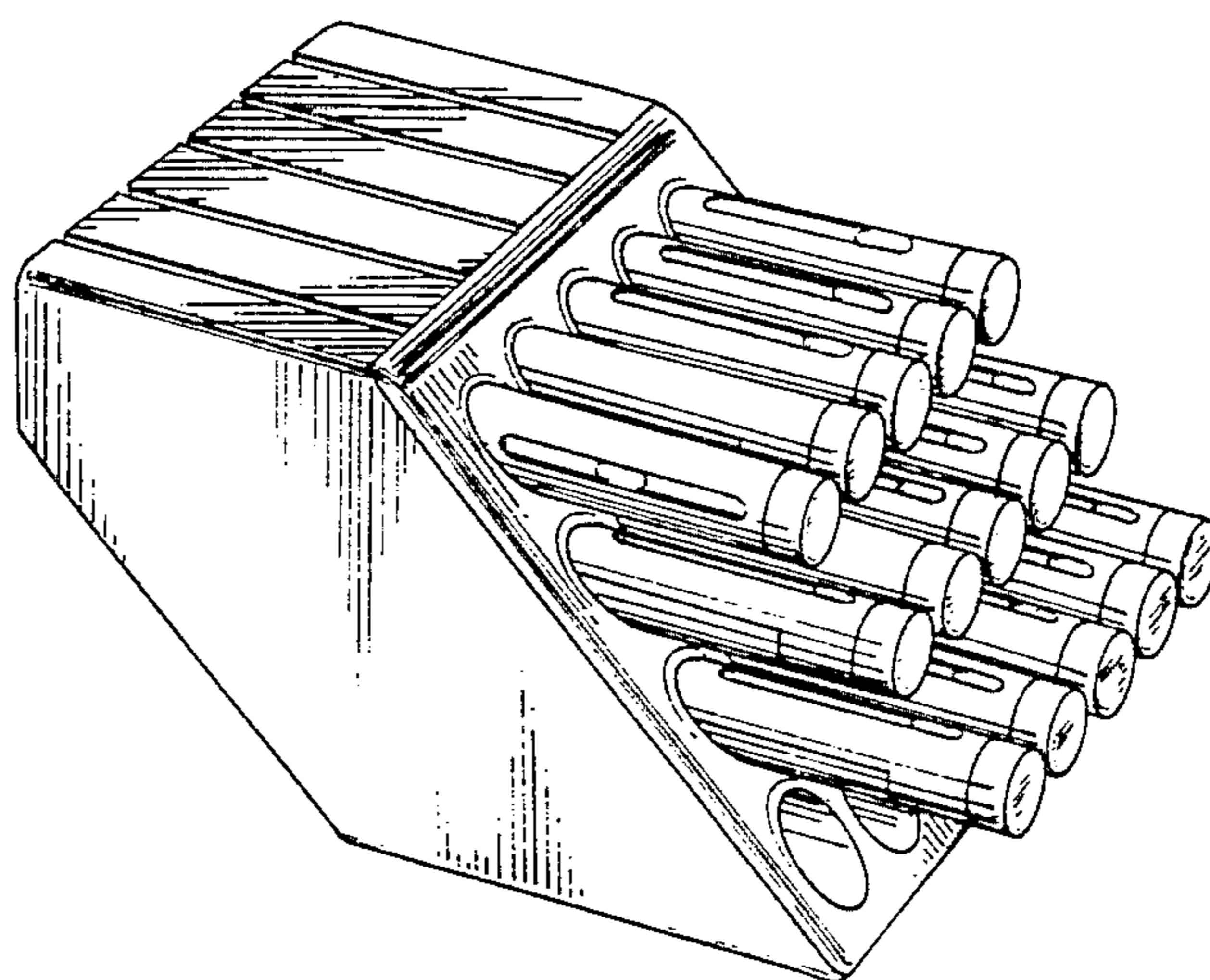

FIG. 15

FIG. 16

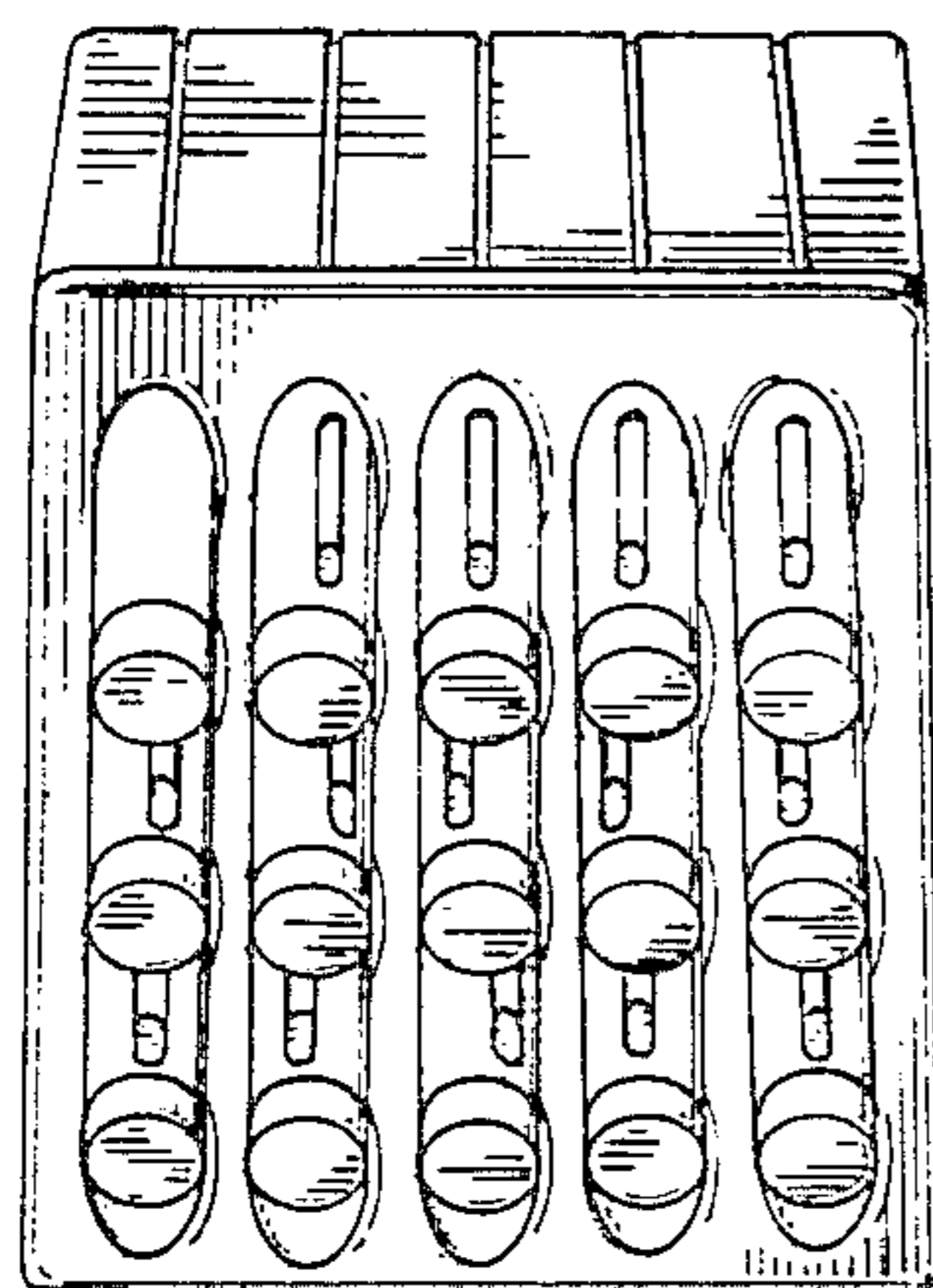

FIG. 17

