

[54] **OPERATORY MODULE FOR A HEALTH TREATMENT FACILITY**

[75] Inventors: **Robert Case**, Chicago, Ill.; **Randall N. Bartlett**, Bay Minette, Ala.; **James D. Alsup, Jr.**, Conyers, Ga.

[73] Assignee: **Syntex (U.S.A.) Inc.**, Palo Alto, Calif.

[**] Term: **14 Years**

[21] Appl. No.: **514,916**

[22] Filed: **Jul. 18, 1983**

[52] U.S. Cl. **D24/4; D24/1.1; D6/425**

[58] **Field of Search** D24/1.1, 2, 4, 5, 7; D23/26, 48, 49, 59; D6/432, 436, 445-448, 422-426; 433/77-79; 312/107, 199, 200, 201, 203, 198, 209, 228, 229, 237

[56] **References Cited**

U.S. PATENT DOCUMENTS

D. 225,996	1/1973	Schwartz	D24/4
D. 226,483	3/1973	Schwartz	D24/4
D. 227,891	7/1973	Welsh	D23/49 X
D. 229,463	12/1973	Marshall et al.	D24/4 X
D. 240,134	6/1976	Pierson	D24/4
D. 267,340	12/1982	Watanabe	D24/4
3,250,583	5/1966	Phillips	312/209
3,455,620	7/1969	Coburn	433/77 X
3,524,256	8/1970	Barker	433/78
3,547,505	12/1970	Ott et al.	312/209

3,997,218 12/1976 Wolf et al. 312/209

FOREIGN PATENT DOCUMENTS

886999	11/1971	Canada	433/77
2439687	3/1976	Fed. Rep. of Germany	433/77
2808294	8/1978	Fed. Rep. of Germany	433/77

Primary Examiner—Catherine E. Kemper
Attorney, Agent, or Firm—Derek P. Freyberg; David A. Lowin

[57] **CLAIM**

The ornamental design for an operatory module for a health treatment facility, as shown and described.

DESCRIPTION

FIG. 1 is a front elevational view of an operatory module for a health treatment facility, showing our new design;
FIG. 2 is a rear elevational view thereof;
FIG. 3 is a right side elevational view thereof;
FIG. 4 is a left side elevational view thereof;
FIG. 5 is a top plan view thereof;
FIG. 6 is a front perspective view thereof, shown with the door open and fully recessed;
FIG. 7 is a front perspective view of a second embodiment of an operatory module for a health treatment facility, shown with the door open and partially recessed; and
FIG. 8 is a front elevational view of a third embodiment of an operatory module for a health treatment facility, shown with the door closed.

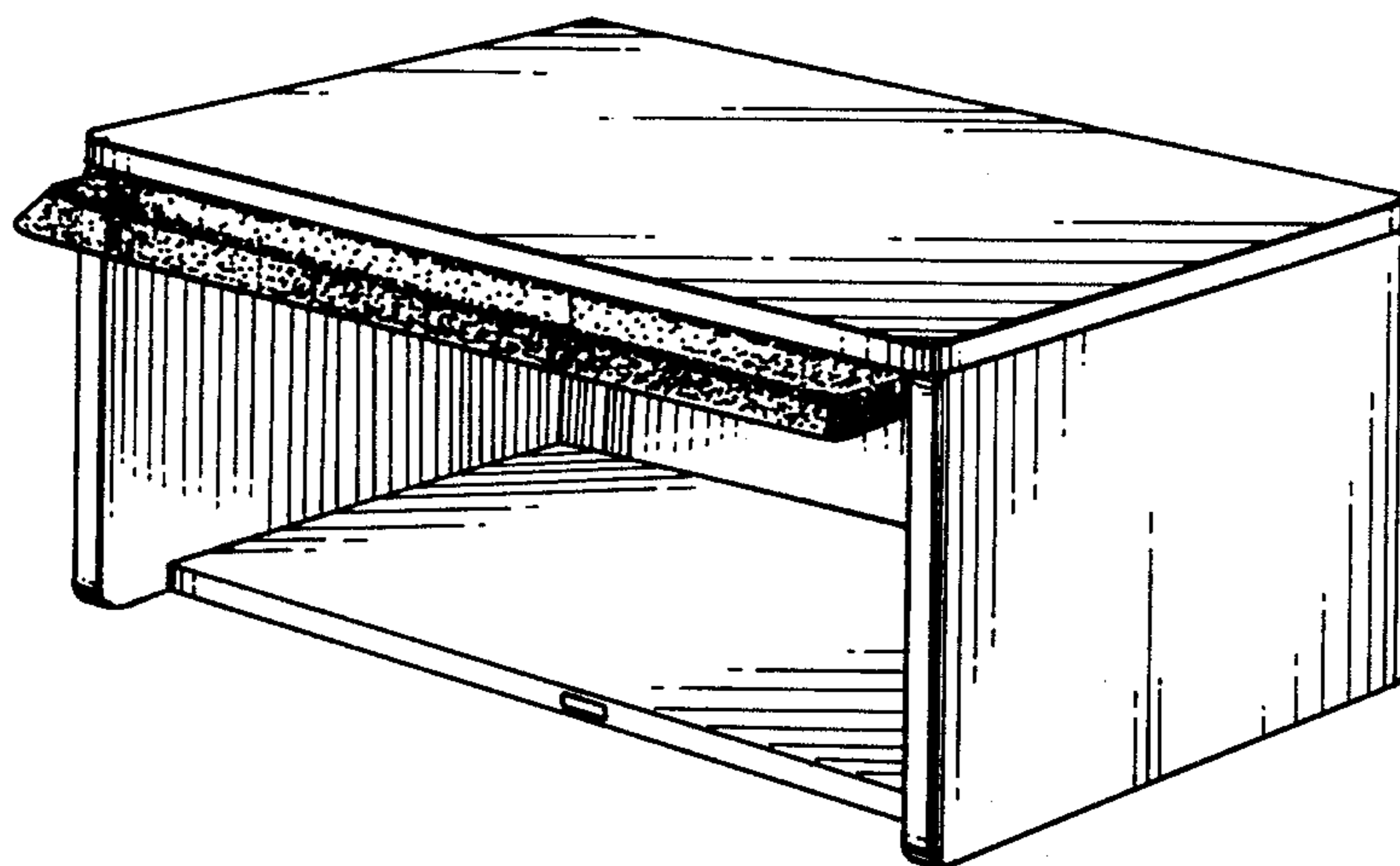

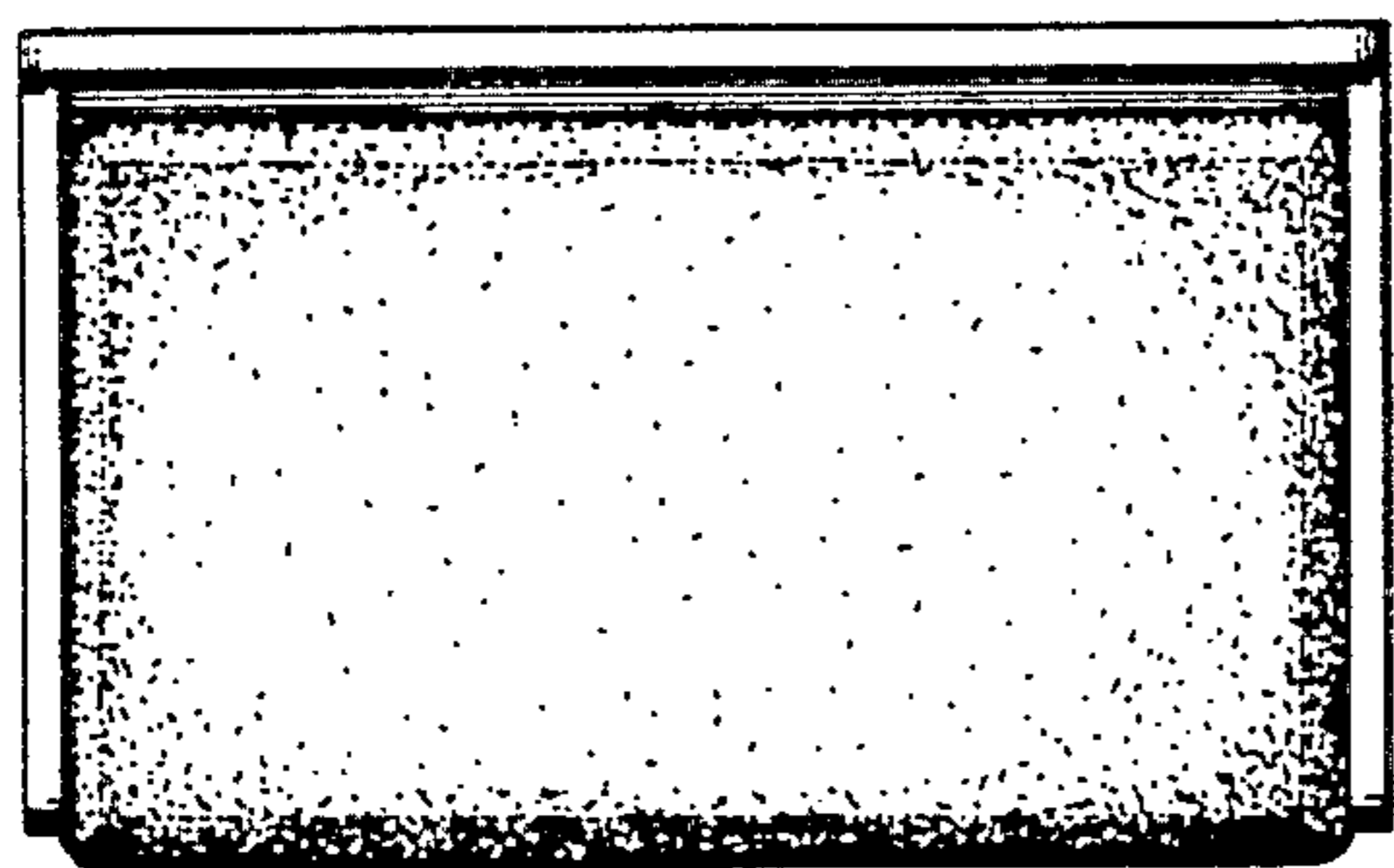

FIG. 1

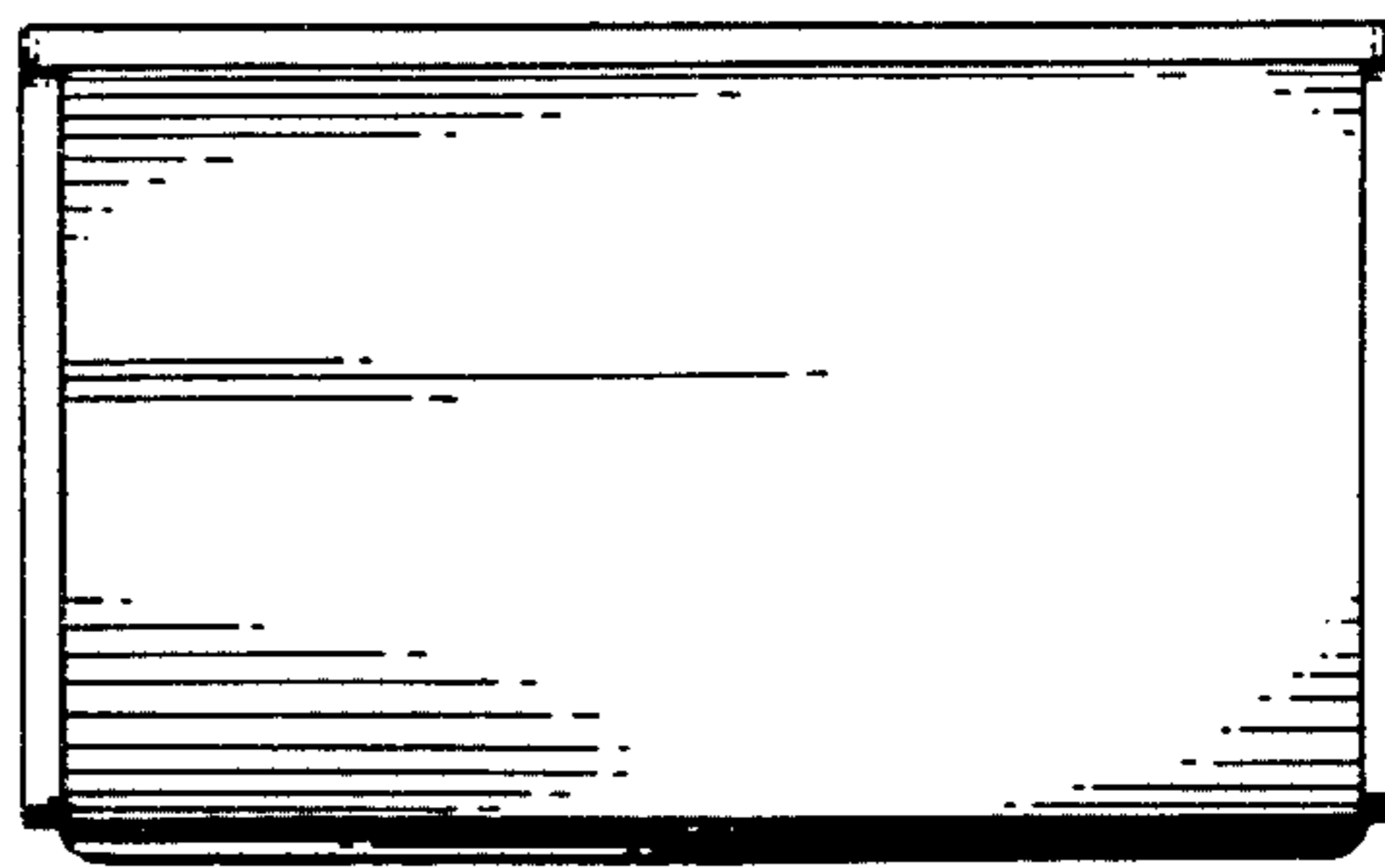

FIG. 2

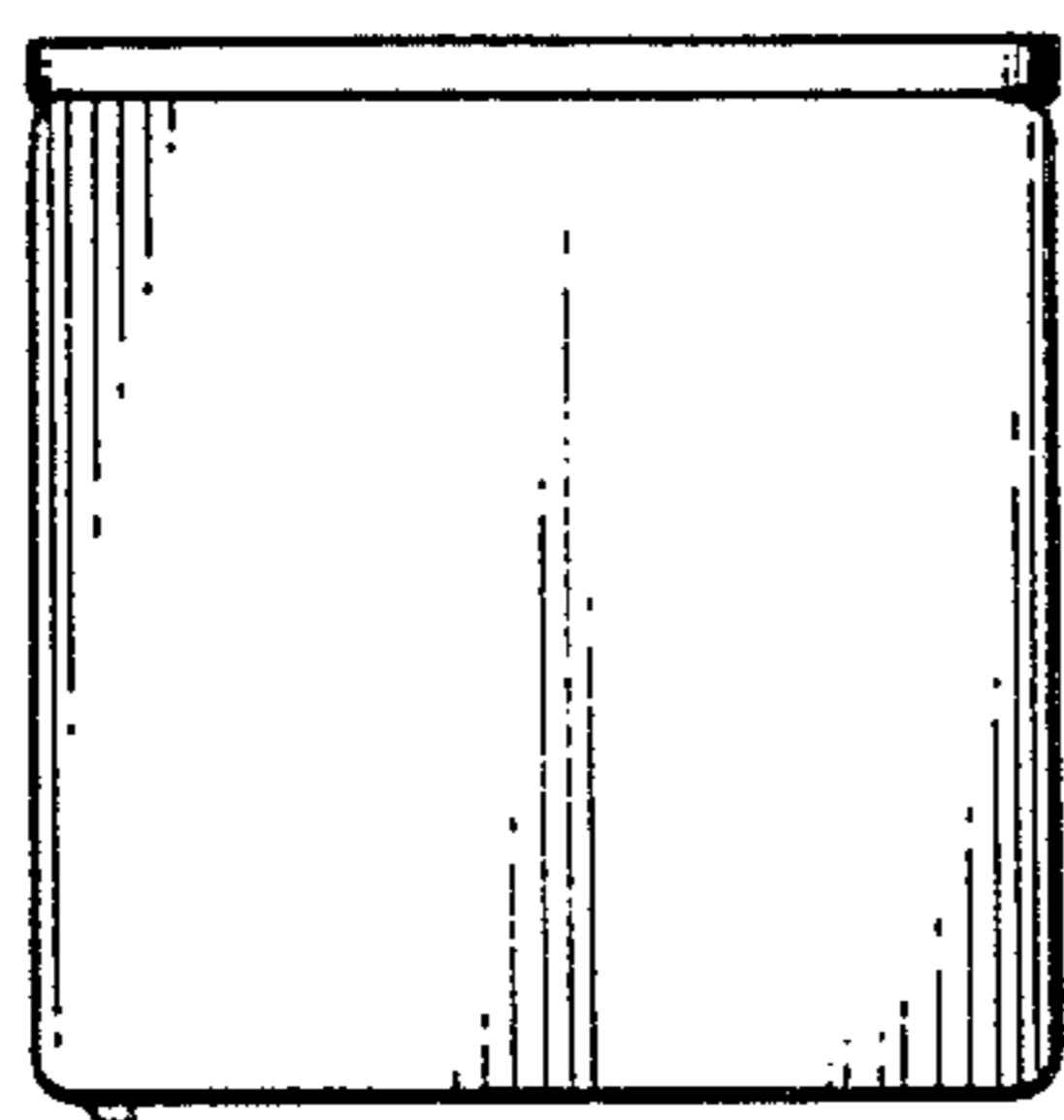

FIG. 3

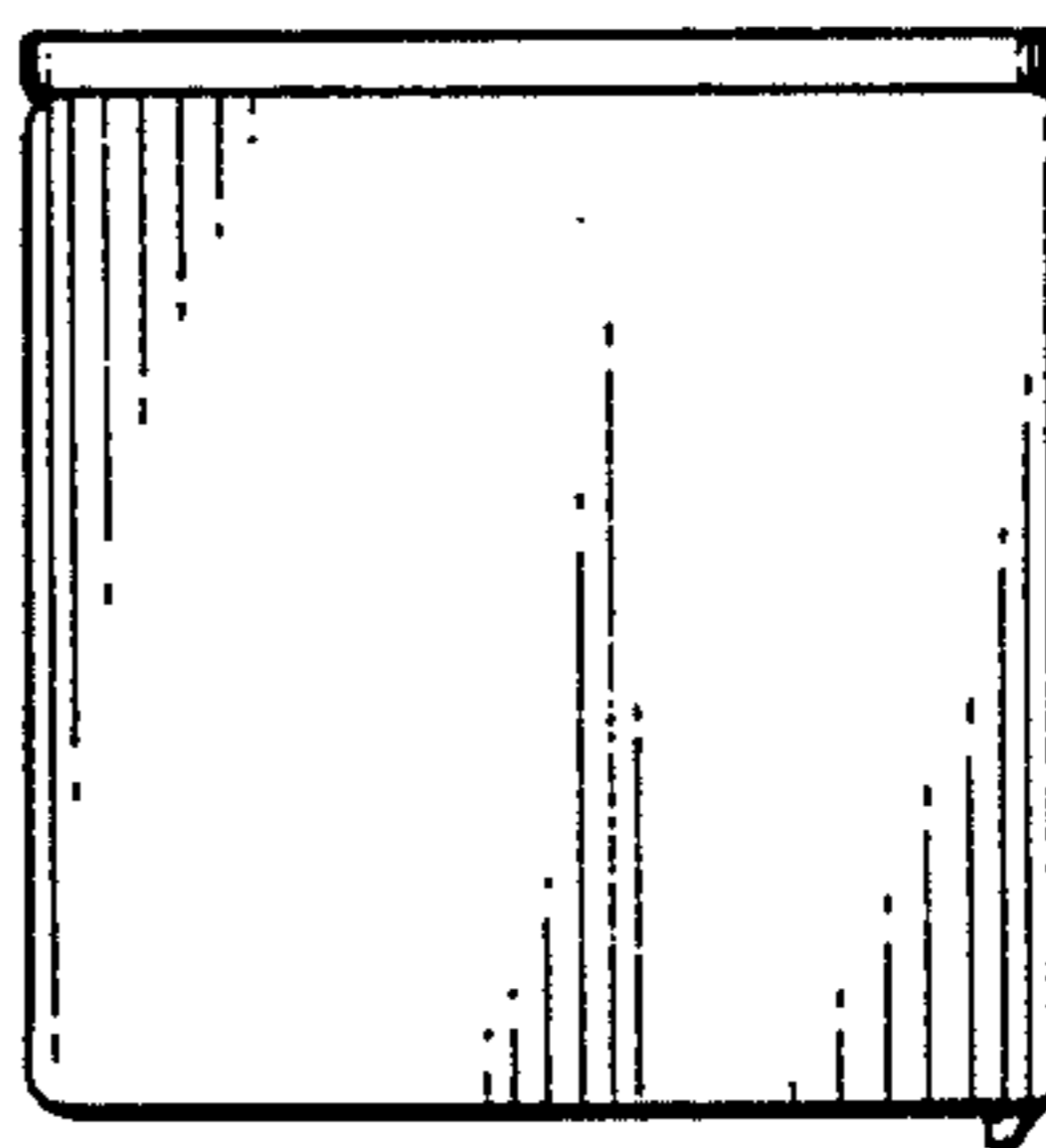

FIG. 4

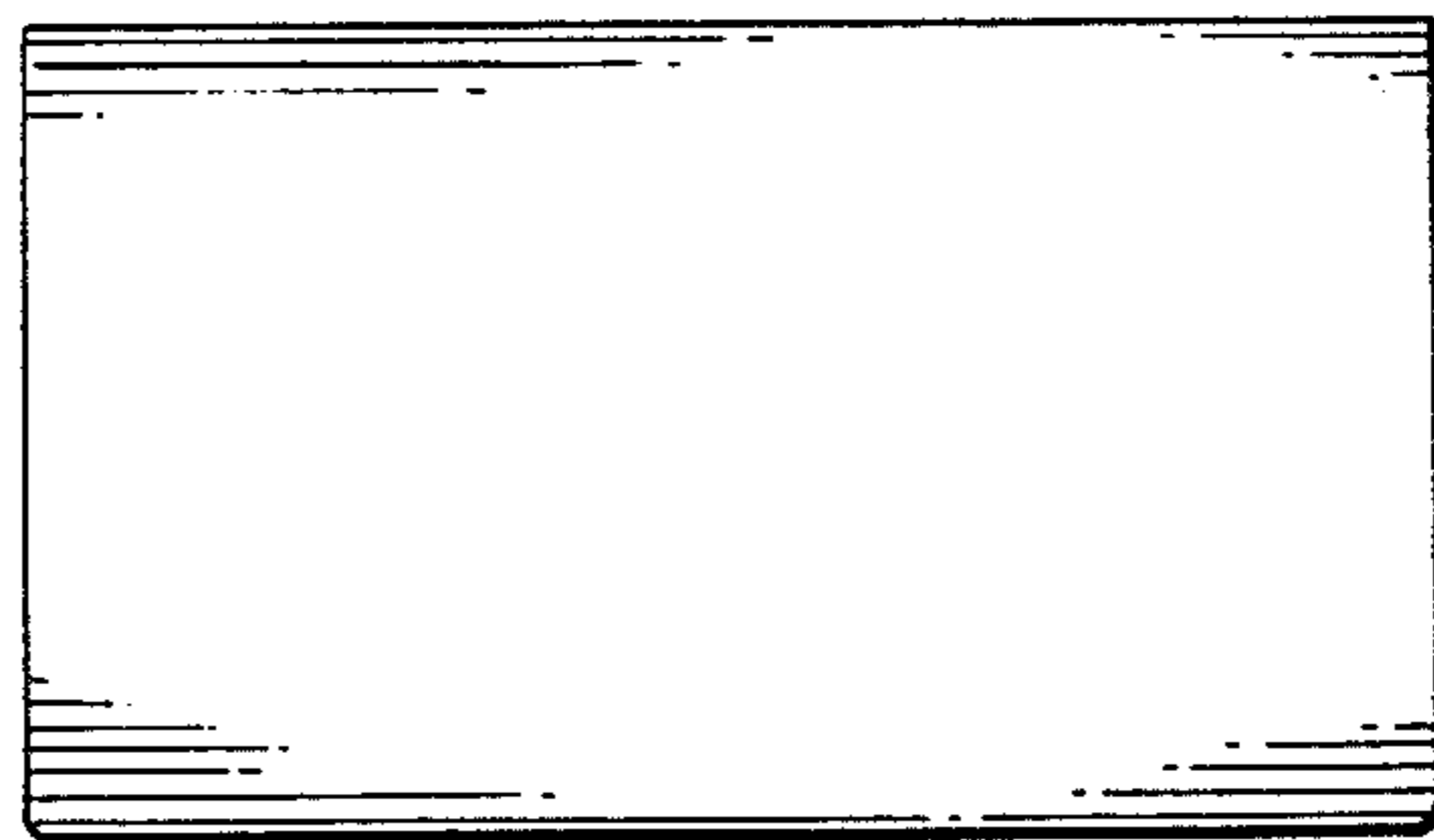

FIG. 5

FIG. 6

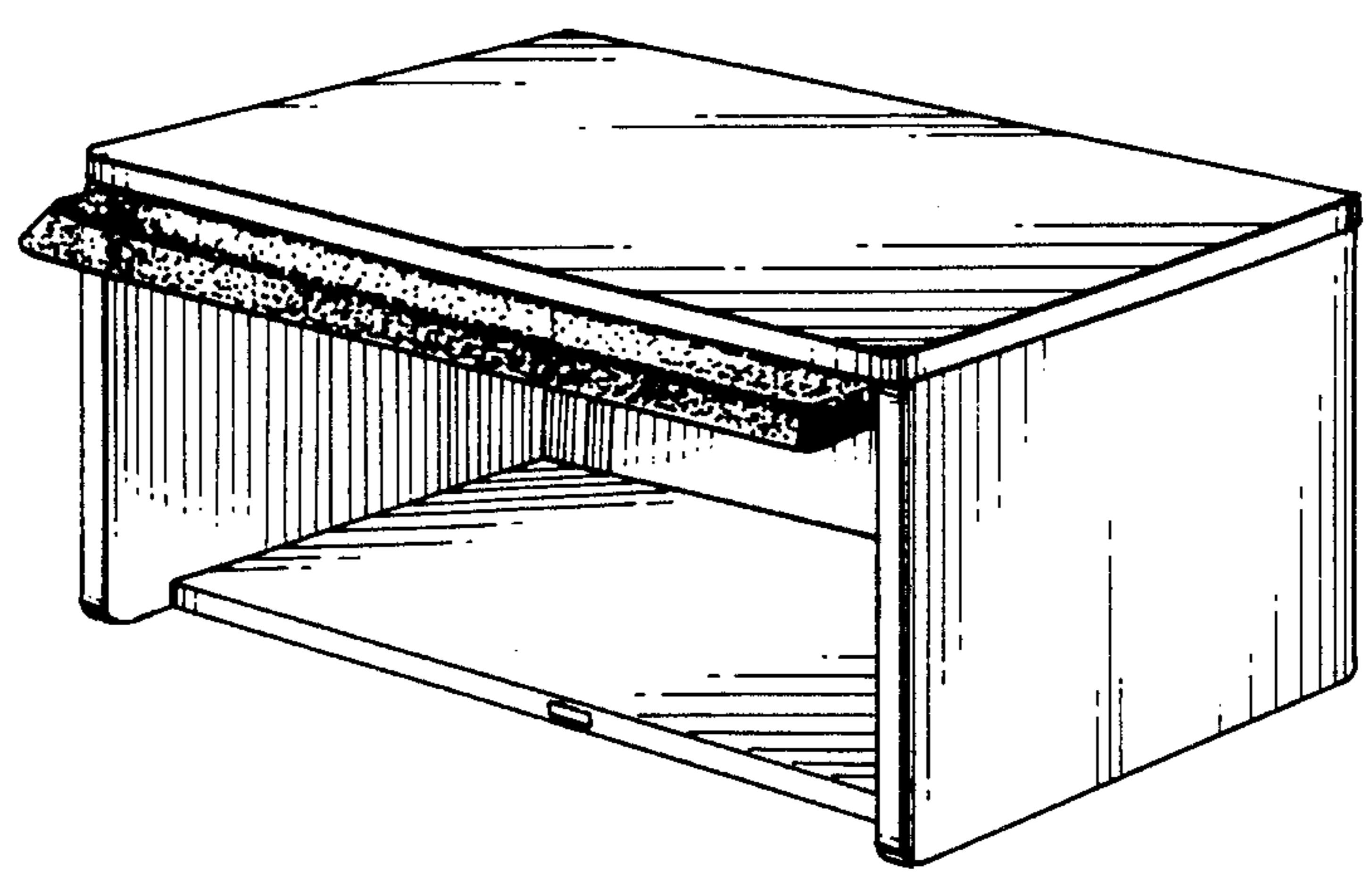

FIG. 7

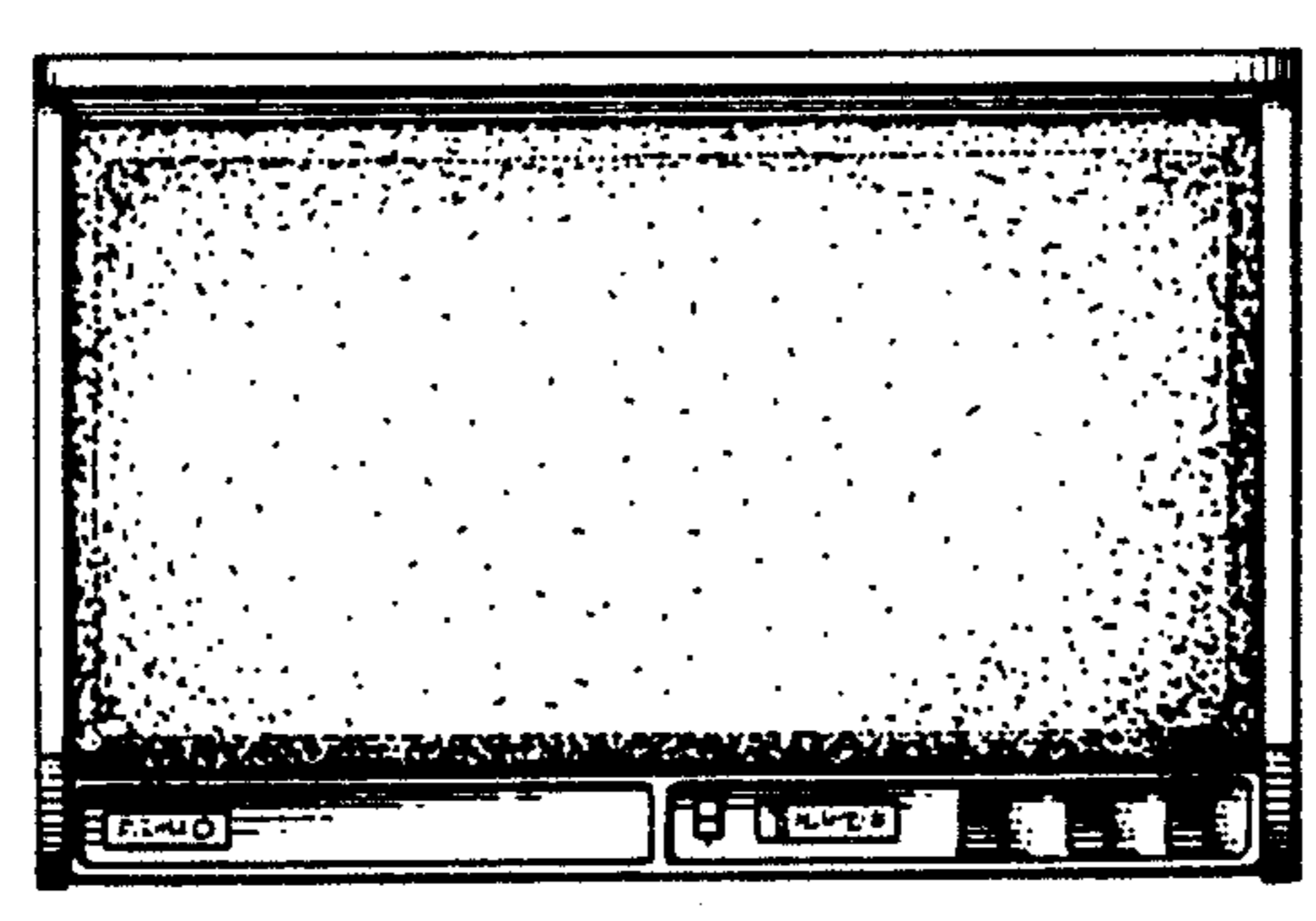
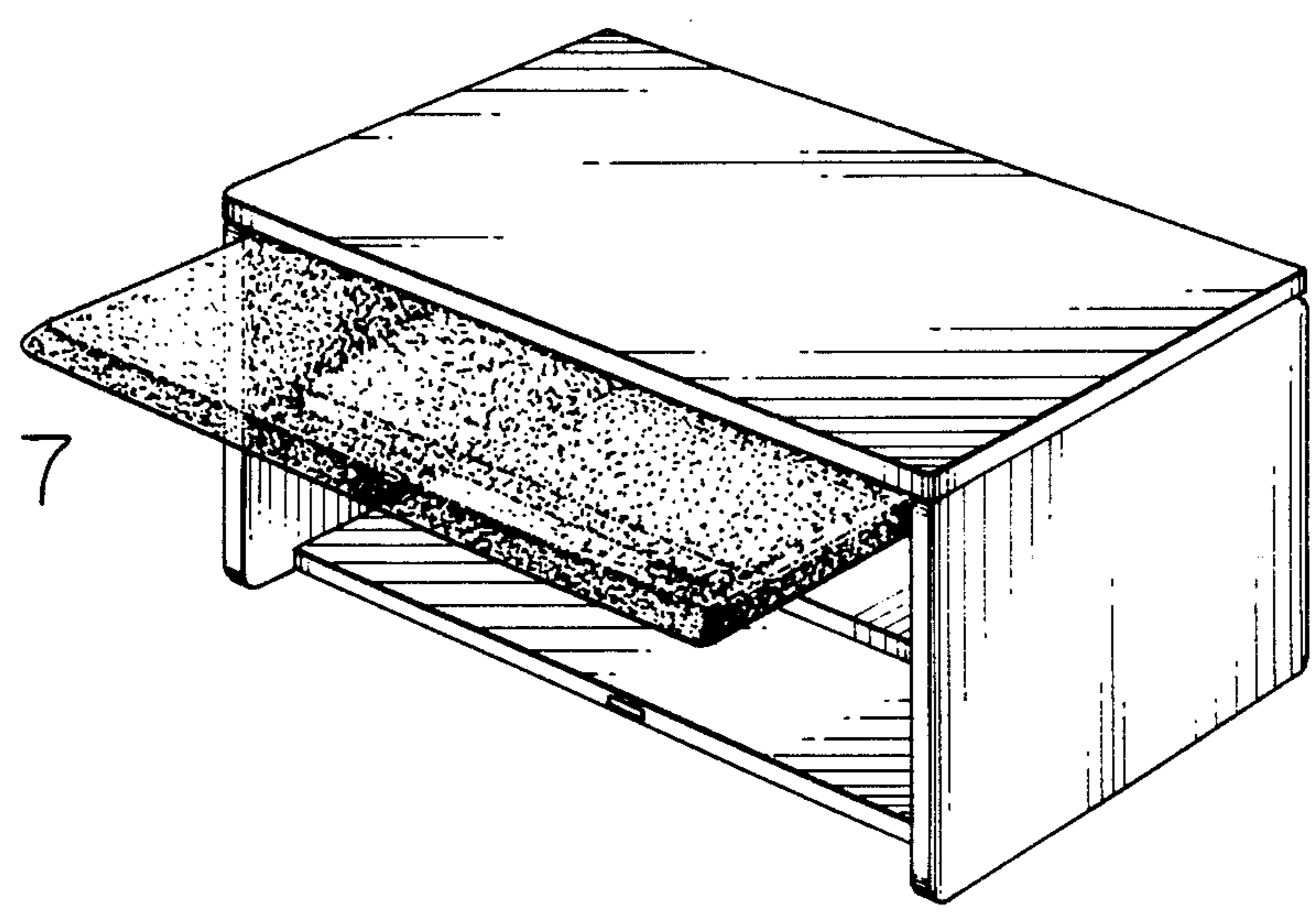

FIG. 8