

[54] LAVATORY BASIN

[75] Inventor: Gerard Tuduri, Paris, France

[73] Assignee: Allia, Paris, France

[**] Term: 14 Years

[21] Appl. No.: 464,875

[22] Filed: Feb. 8, 1983

[30] Foreign Application Priority Data

Aug. 10, 1982 [FR] France 882.774

[52] U.S. Cl. D23/58

[58] Field of Search D23/58-64;
4/619, 631, 637, 643, 646

[56] References Cited

U.S. PATENT DOCUMENTS

- D. 27,064 5/1897 Scott D23/58
- D. 30,135 2/1899 Peet D23/58
- D. 215,291 9/1969 Owings D23/58
- D. 236,831 9/1975 Myers D23/58

- D. 238,073 12/1975 Ganger D23/58
- D. 253,487 11/1979 Thompson D23/58
- D. 260,678 9/1981 Hiller D23/58

Primary Examiner—James R. Largen
Attorney, Agent, or Firm—Littlepage & Webner

[57] CLAIM

The ornamental design for a lavatory basin, substantially as shown and described.

DESCRIPTION

FIG. 1 is a top plan view of a lavatory basin showing my new design;
 FIG. 2 is a front elevational view thereof;
 FIG. 3 is a right side elevational view thereof, the left side being a mirror image of the right side shown;
 FIG. 4 is a bottom plan view thereof;
 FIG. 5 is a rear elevational view thereof;
 FIG. 6 is a perspective view taken from the top, front and right side thereof; and
 FIG. 7 is a cross sectional view taken on line 7—7 of FIG. 1.

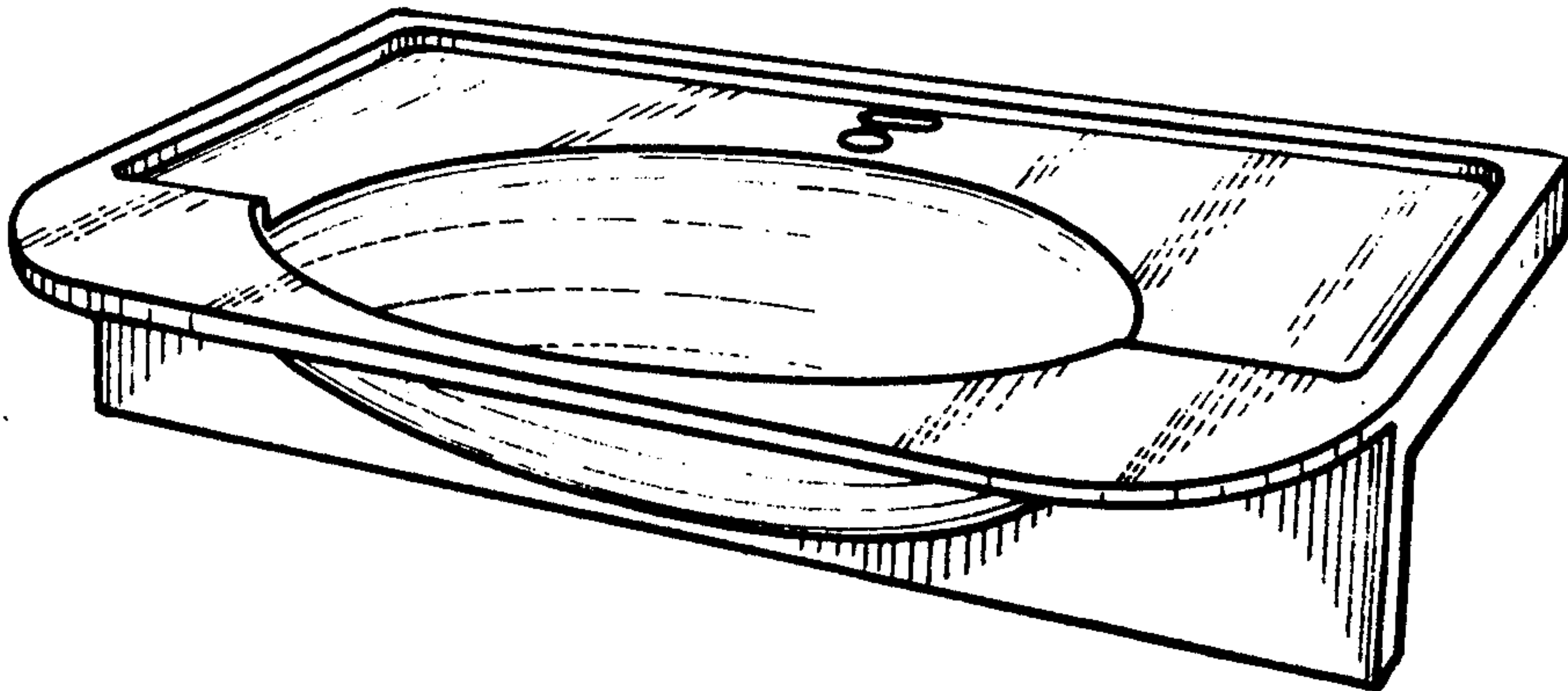

FIG.3

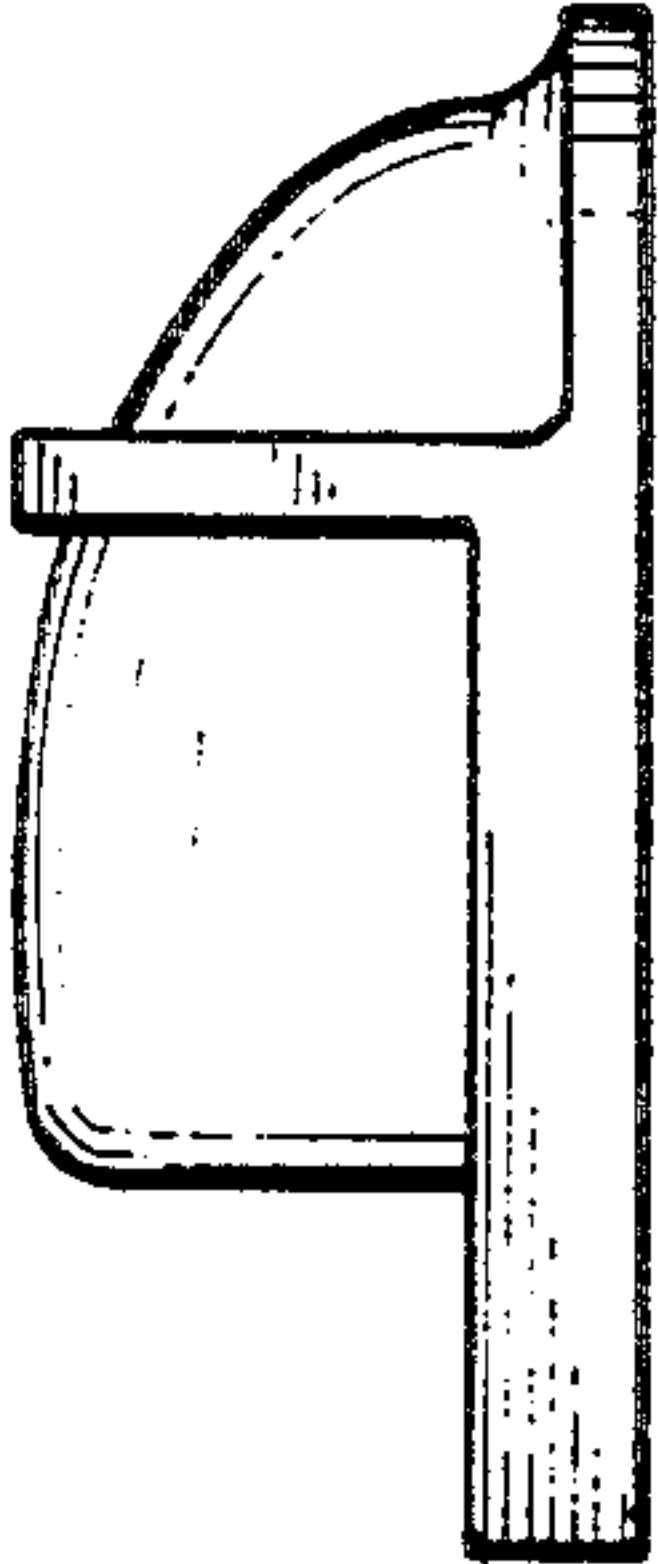

FIG. 4

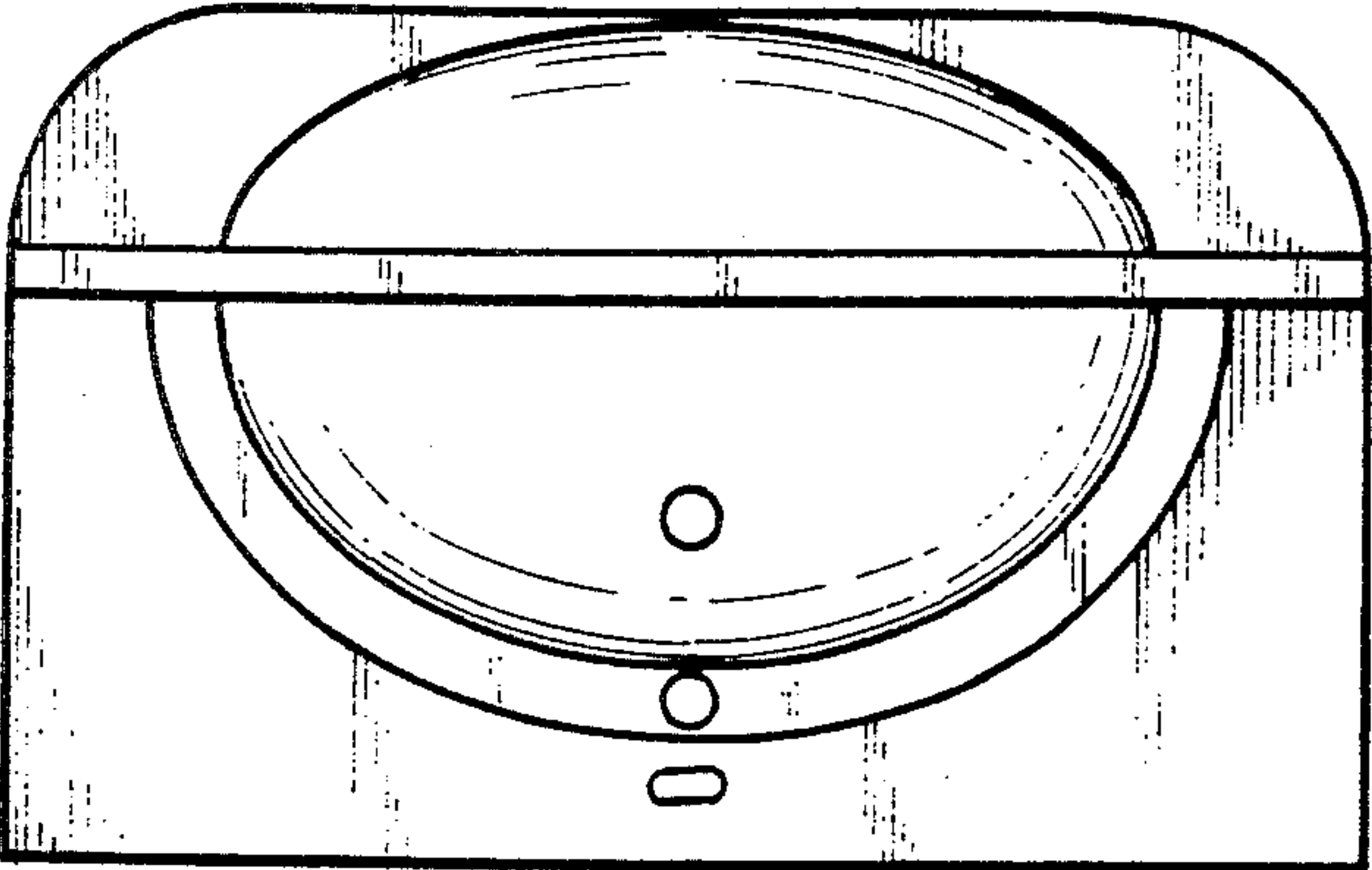

FIG. 2

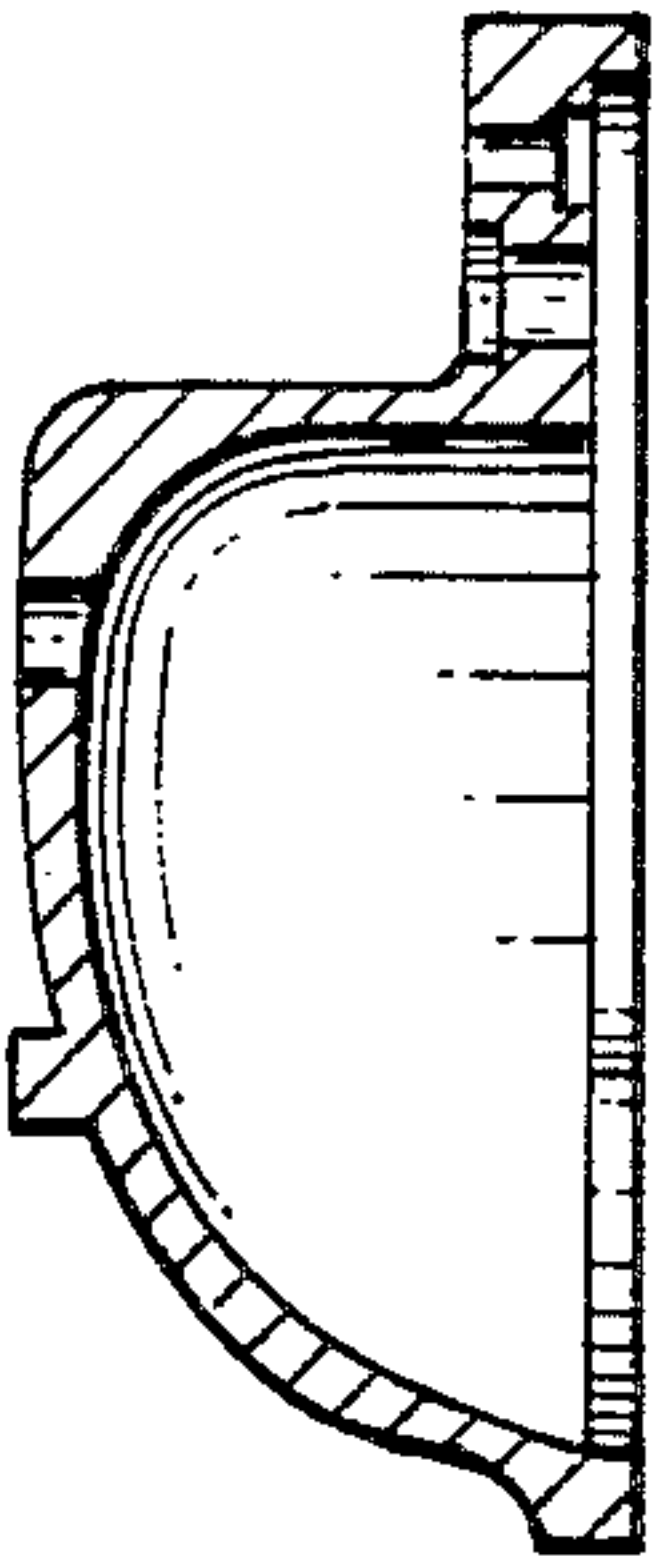
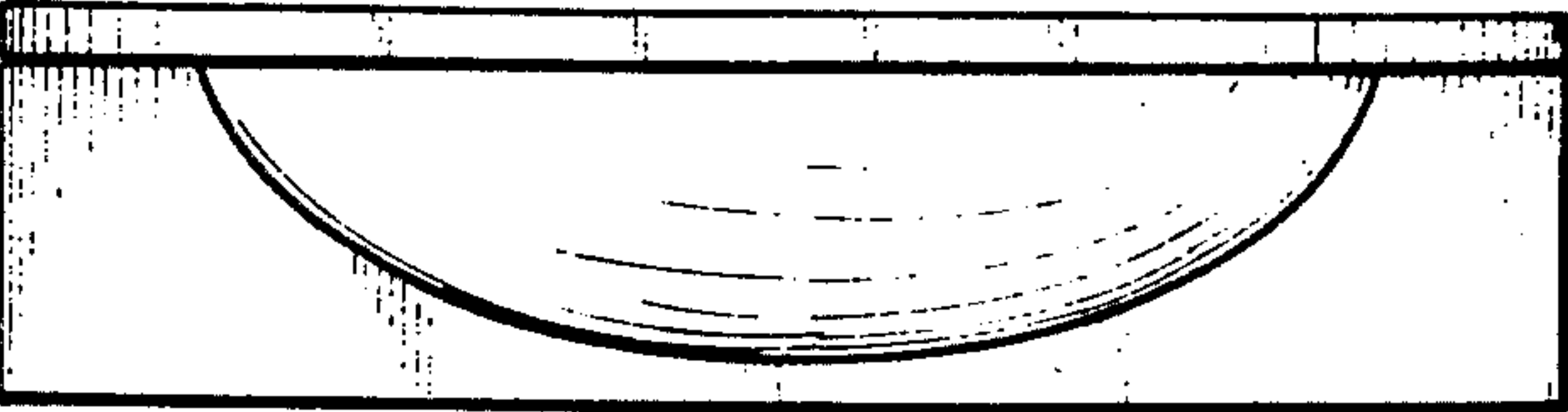

FIG. 7

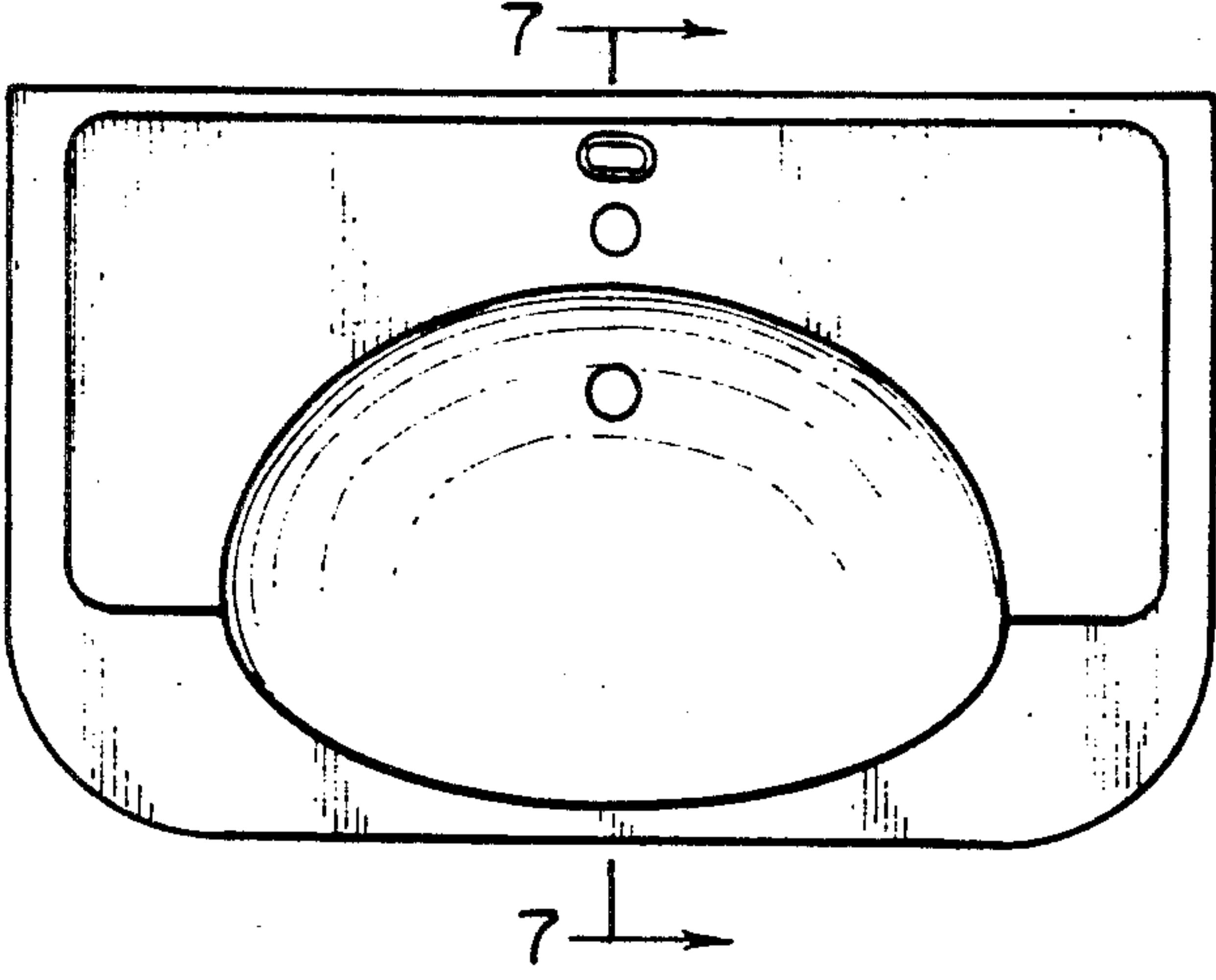

FIG. 1

FIG. 5

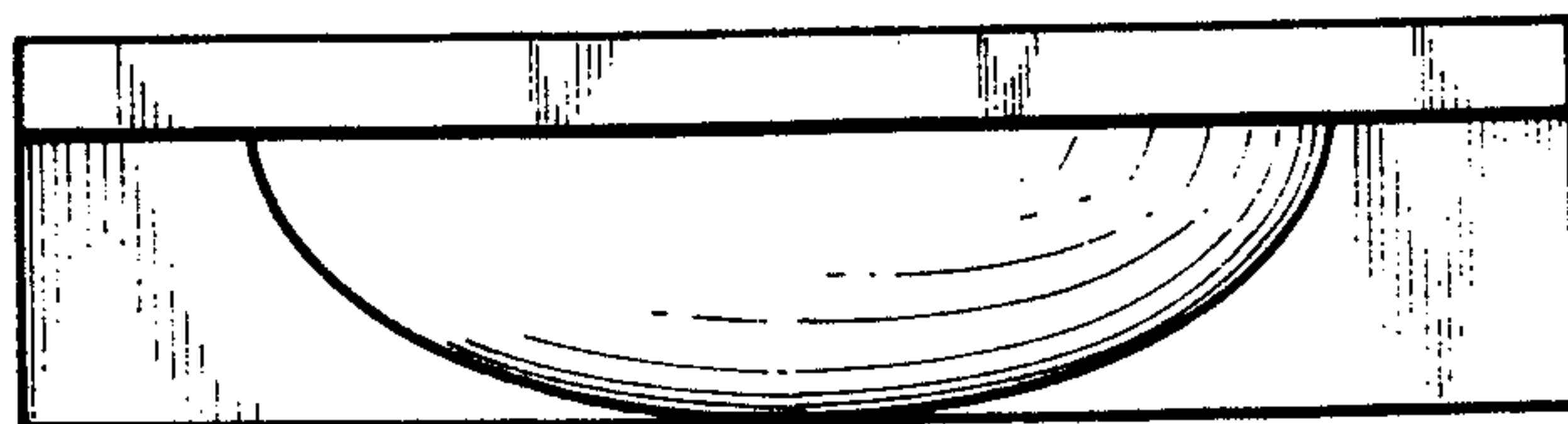

FIG. 6

