

[54] SUCTION COAGULATOR

[75] Inventor: John T. Shackelford, Longmount, Colo.

[73] Assignee: Aspen Laboratories, Inc., Englewood, Colo.

[**] Term: 14 Years

[21] Appl. No.: 520,402

[22] Filed: Aug. 4, 1983

[52] U.S. Cl. D24/54

[58] Field of Search D24/51, 53; 128/276, 128/275.1, 303.14, 303.17; 604/35, 118, 119, 212, 239, 268, 902

[56] References Cited

U.S. PATENT DOCUMENTS

Re. 29,678	6/1978	Antonini et al.	206/571
D. 216,235	12/1969	Slee et al.	D24/60 X
D. 249,549	9/1978	Pike	D24/30
1,987,907	1/1935	Jenkins	604/902 X
3,659,610	5/1972	Cimber	604/162 X
3,720,896	3/1973	Beierlein	335/206
3,801,766	4/1974	Morrison, Jr.	200/157
3,828,780	8/1974	Morrison, Jr.	128/275.1
3,902,494	9/1975	Haberlen et al.	128/275.1
3,911,241	10/1975	Jarrard	200/157
3,938,527	2/1976	Rioux et al.	128/303.17
3,974,833	8/1976	Durden	128/275.1
4,034,761	7/1977	Prater et al.	128/303.14
4,112,950	9/1976	Pike	128/303.14
4,170,234	10/1979	Graham	128/303.14
4,202,337	5/1980	Hren et al.	128/303.14
4,282,873	8/1981	Roth	604/37 X
4,347,842	9/1982	Beale	128/276
4,400,168	8/1983	Buechel et al.	604/48

FOREIGN PATENT DOCUMENTS

2350945 10/1973 Fed. Rep. of Germany 604/119

OTHER PUBLICATIONS

Zimmer-Medical Surgical Products, Suction Coagulators, p. F18, Items 60-0811, 60-0813, 60-0814, ©1981. Zimmer-Aspen-New Product Announcement date

10/7/83, Disposable Handswitching Suction Coagulator.

Durden Suction Cautery-Durden Enterprises, Alburn Ga., Durden Catalogy, p. 154, Disposable Suction Cauterizer-Product #89-0300, #89-0302 and #89-0303.

Valleylab Brochure "LectroVac Suction Coagulation Electrode Product #E2505-10 and E2506-10-Lit. No. 945-600-050, 12-81.

Valleylab Brochure, "LectroVac II Disposable Hand-switching Suction Coagulation Electrode-Product #E2610-6 and E2610-16, Lit No. 945-600-125, 6-82.

Weck Electrosurgery-Edward Weck and Company, Inc., Long Island City, N.Y., Product #809400 and 809410.

Birtcher Electrosurgical Electrodes and Sets-Birtcher Corporation, Los Angeles, CA-Product #744, 740 & 741, Lit No. 501-K, 3/75.

Cameron-Miller Catalog, p. 7, Suction Coagulators.

Davol-Suction Tubes-Lit. No. HAES-5, 8/78--Product #137302, 137303, and 137304.

Codman-Suction Instruments with Coagulation-Page No. 23F, 11/79.

Primary Examiner-A. Hugo Word

Assistant Examiner-Stella Reid

Attorney, Agent, or Firm-Margaret L. Geringer

[57] CLAIM

The ornamental design for a suction coagulator, as shown and described.

DESCRIPTION

FIG. 1 is a perspective view of a suction coagulator showing my new design;

FIG. 2 is a side elevational view thereof;

FIG. 3 is a top plan view thereof;

FIG. 4 is a bottom plan view thereof;

FIG. 5 is a front elevational view thereof;

FIG. 6 is a rear elevational view thereof;

The broken line showing of the cord is for illustrative purposes only and forms no part of the claimed design.

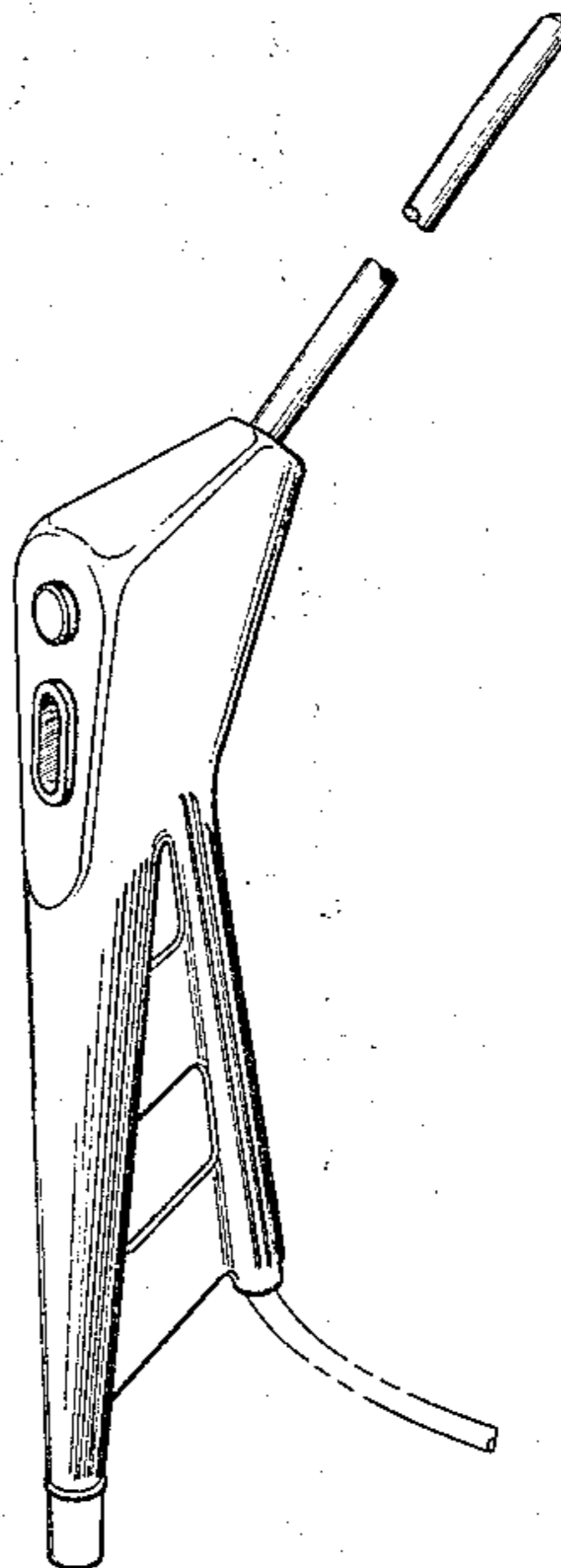

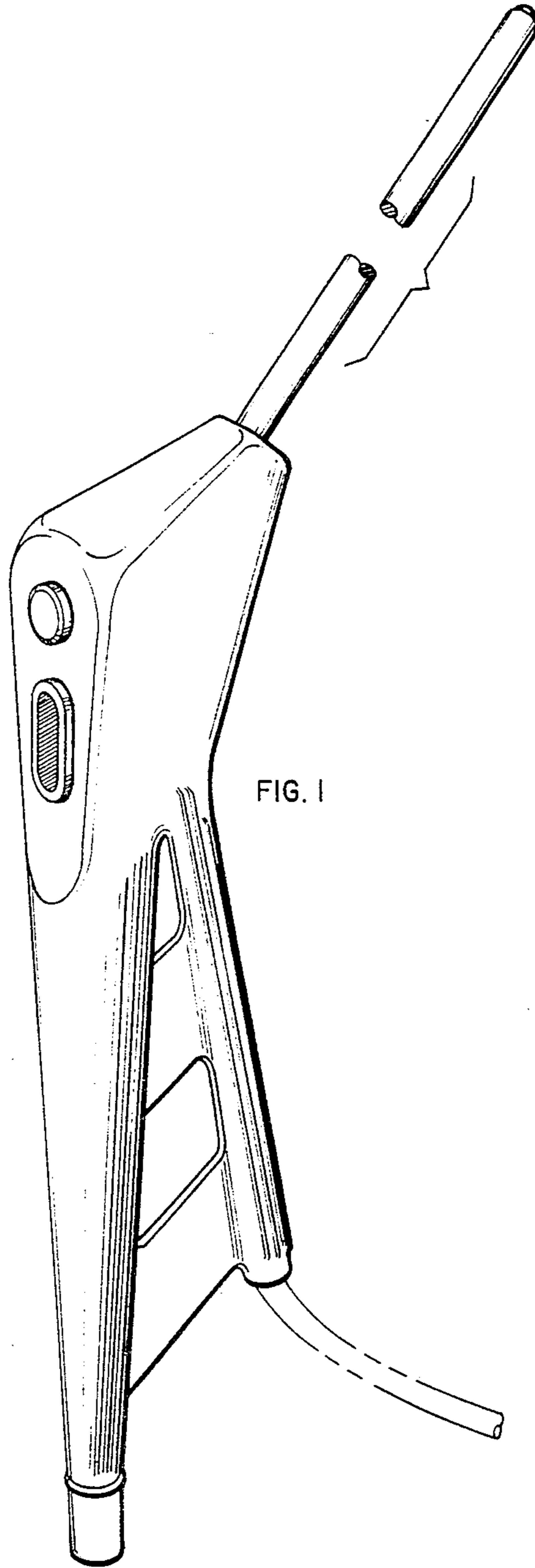

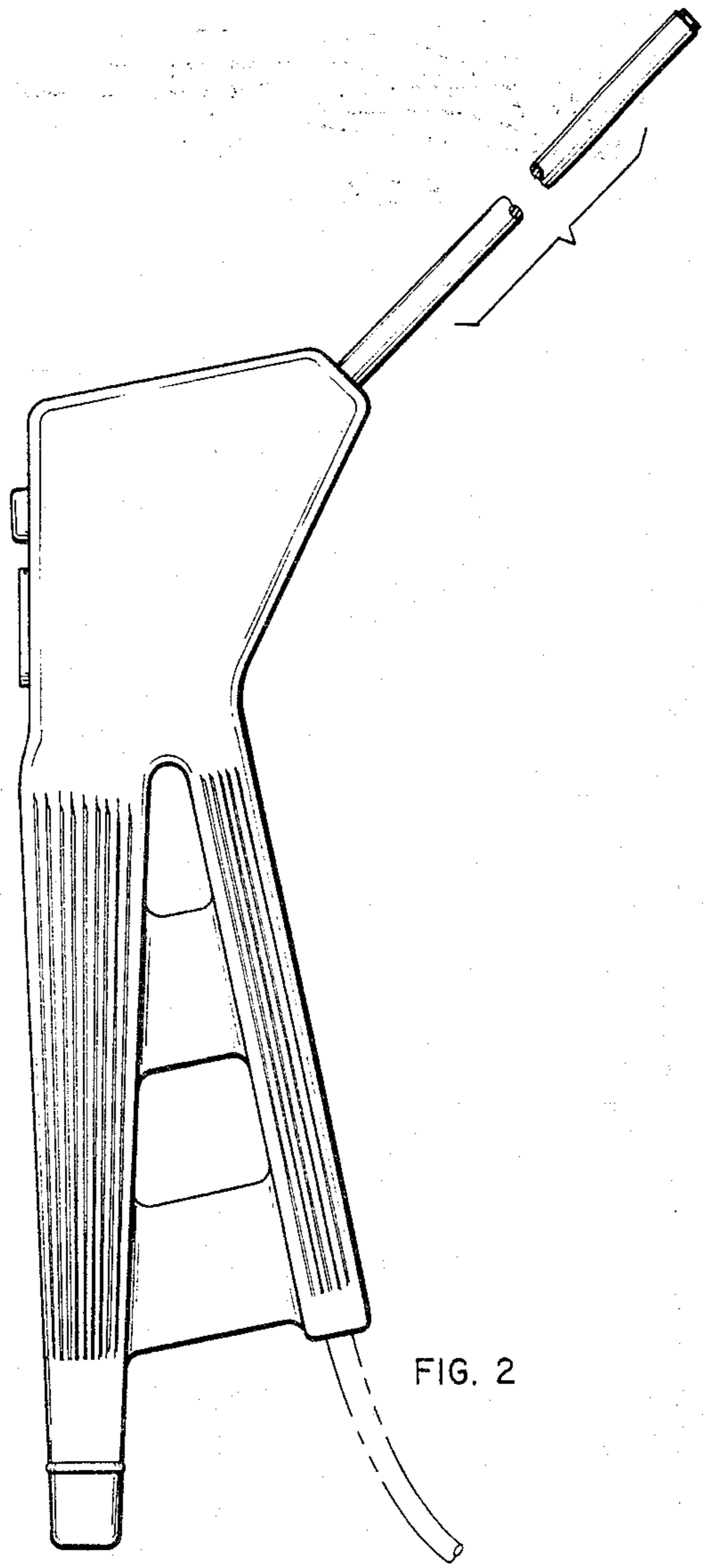

FIG. 2

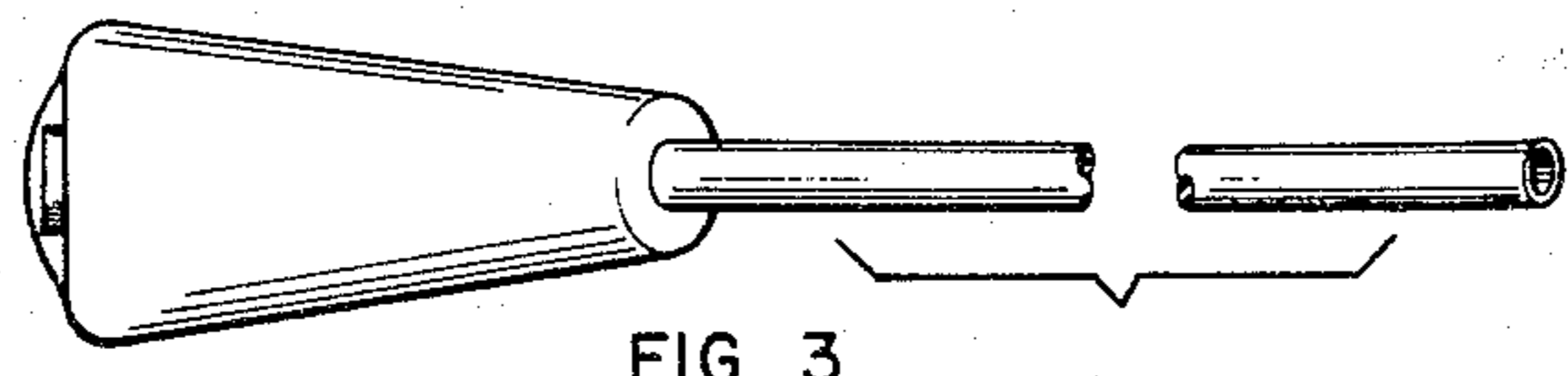

FIG. 3

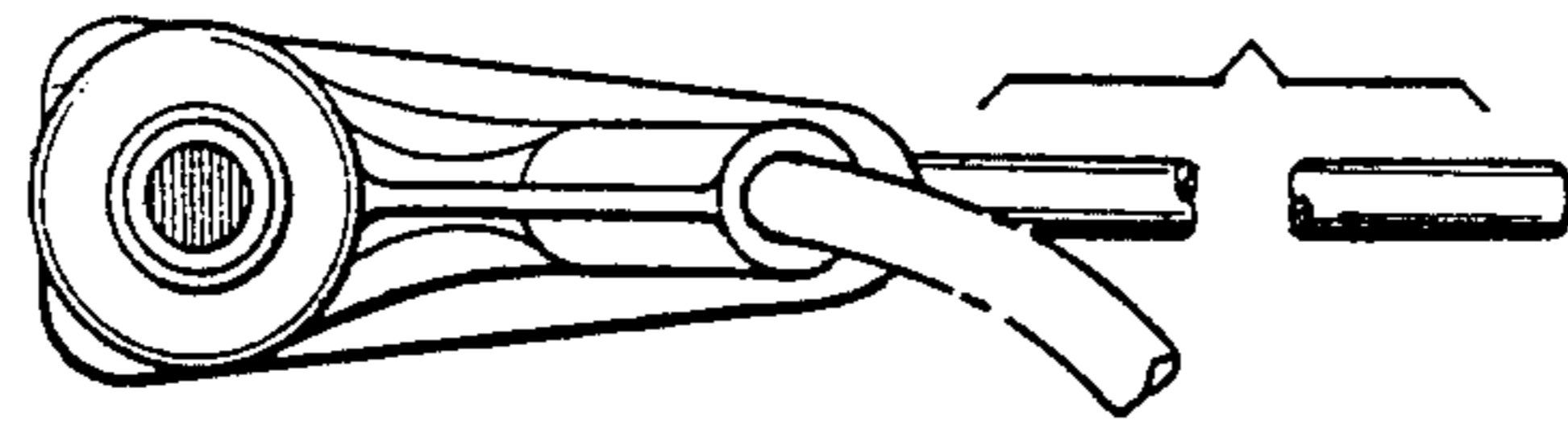

FIG. 4

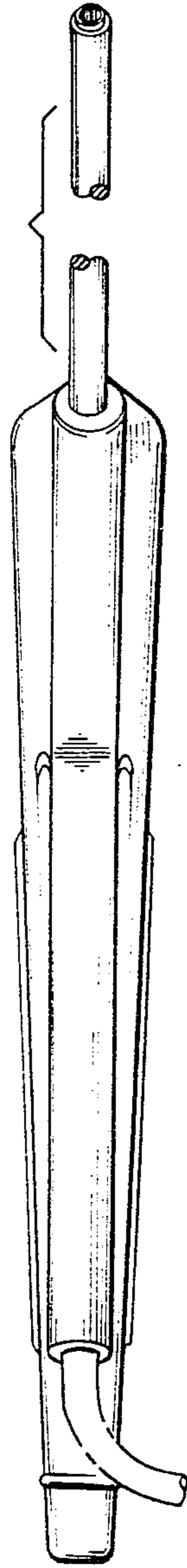

FIG. 5

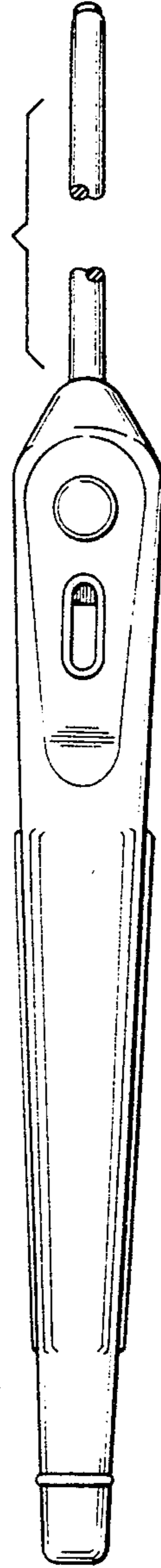

FIG. 6