

[54] **MEAT GRINDING TABLE**

4,200,243 4/1980 Peterson, Jr. 241/37.5

[76] **Inventor: Larry H. Dvorak, Box 57, Manning, N. Dak. 58642**

Primary Examiner—Wallace R. Burke
Assistant Examiner—Lynn Wilder
Attorney, Agent, or Firm—Merchant, Gould, Smith, Edell, Welter & Schmidt

[**] **Term: 14 Years**

[21] **Appl. No.: 512,883**

[57] **CLAIM**

[22] **Filed: Jul. 11, 1983**

The new and ornamental design for a meat grinding table, as shown and described.

[52] **U.S. Cl. D7/372**

[58] **Field of Search D7/372, 368, 382; 241/37.5; 17/25**

DESCRIPTION

[56] **References Cited**

U.S. PATENT DOCUMENTS

D. 178,294	7/1956	Lasar	D7/372
1,951,826	3/1934	Foster	241/37.5
3,109,472	11/1963	Lasar	241/37.5
3,132,679	5/1964	Rees	241/37.5

FIG. 1 is a perspective view of a meat grinding table showing my new design;
FIG. 2 is a front elevational view thereof;
FIG. 3 is a rear elevational view thereof;
FIG. 4 is a view in top plan thereof;
FIG. 5 is a view in bottom plan thereof;
FIG. 6 is a right side elevational view thereof; and
FIG. 7 is a left side elevational view thereof.

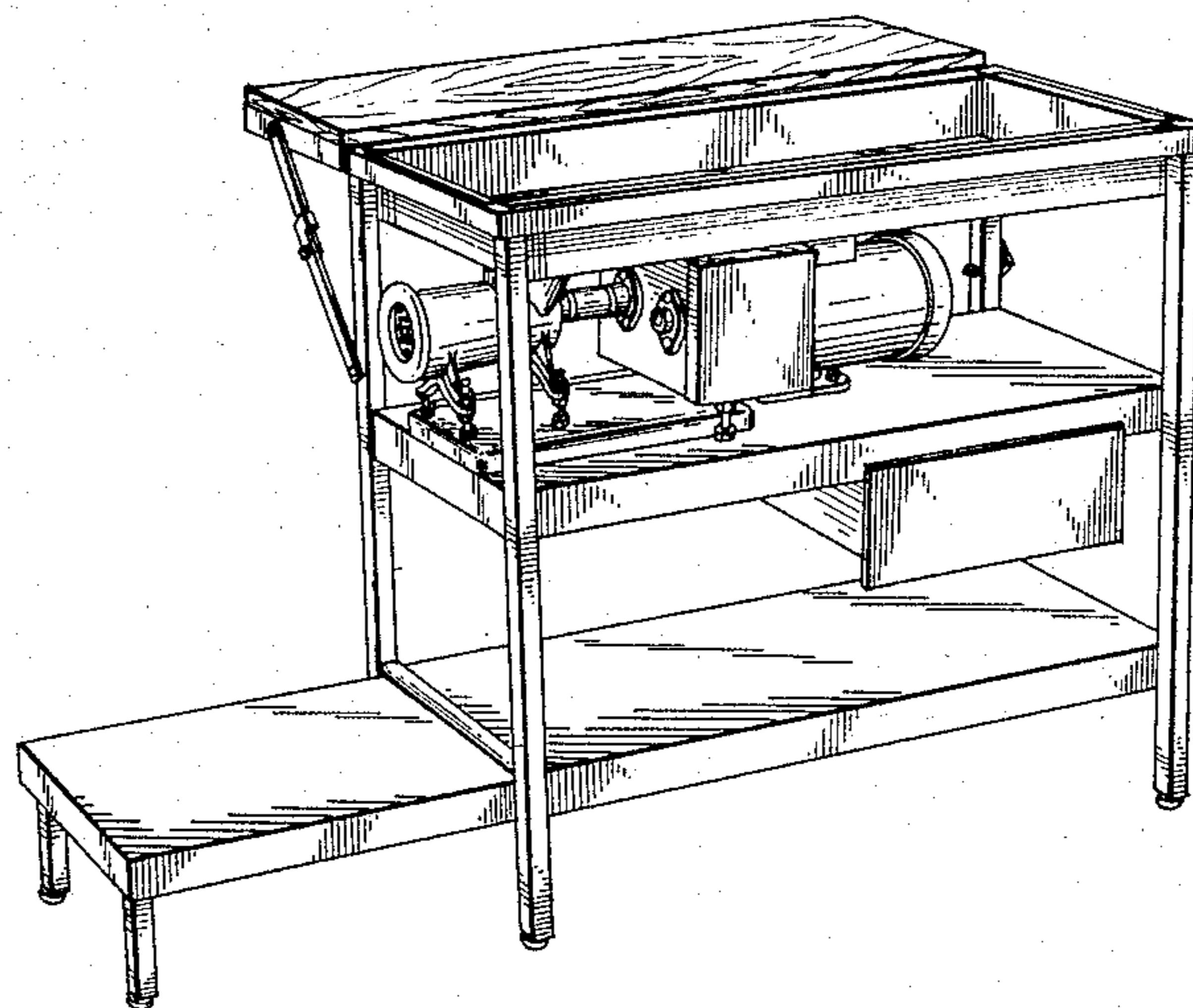

FIG. 1

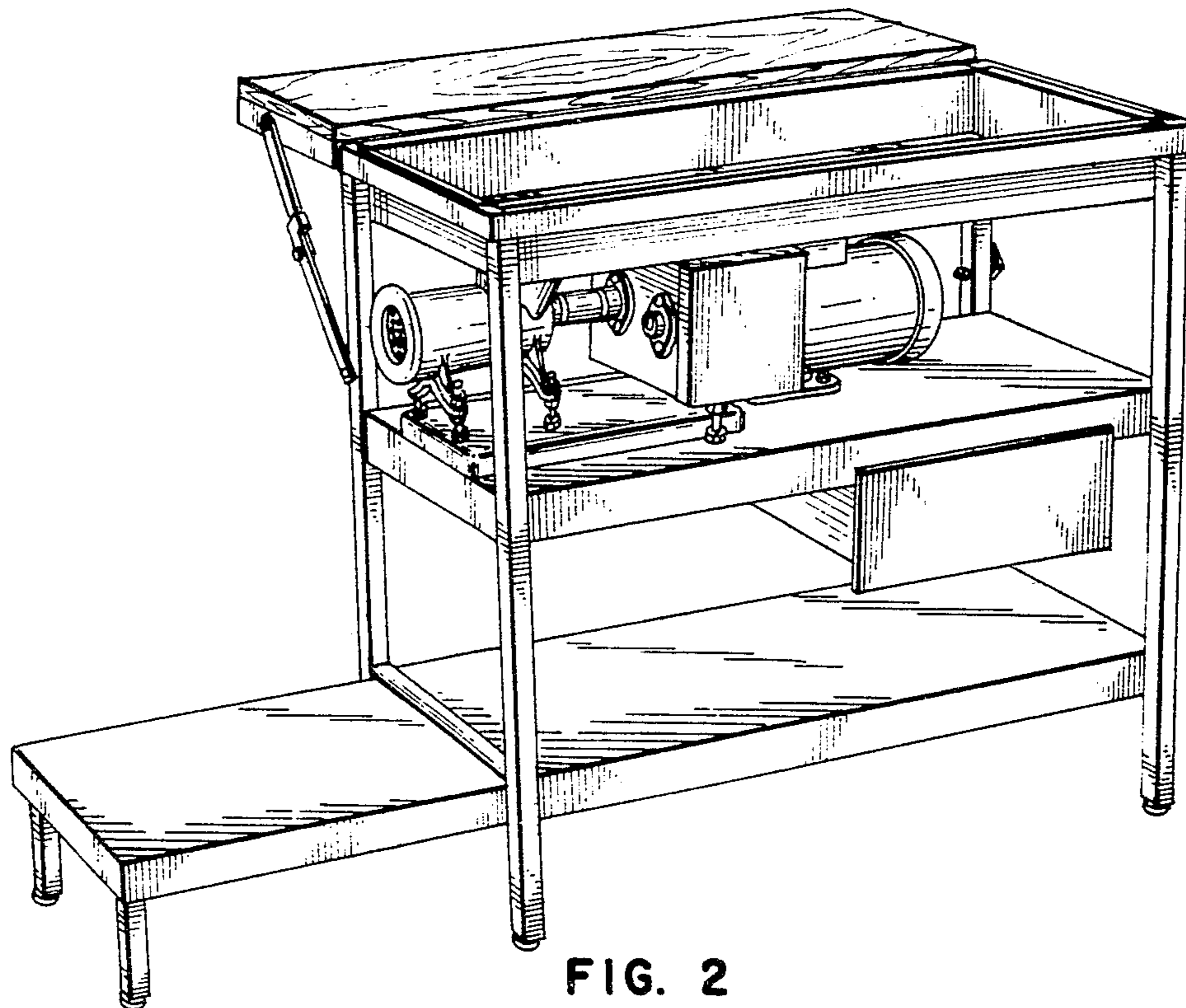

FIG. 2

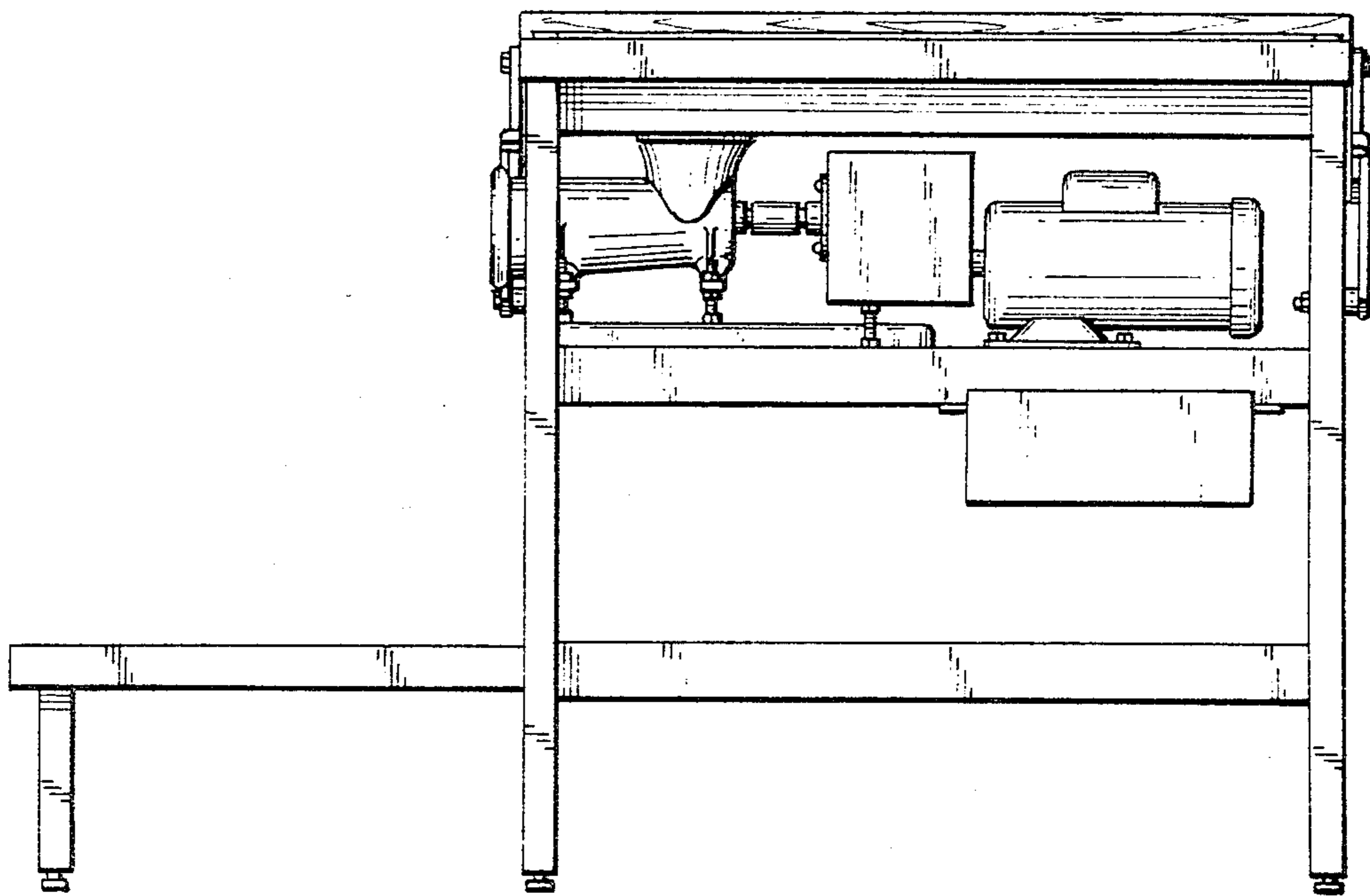

FIG. 3

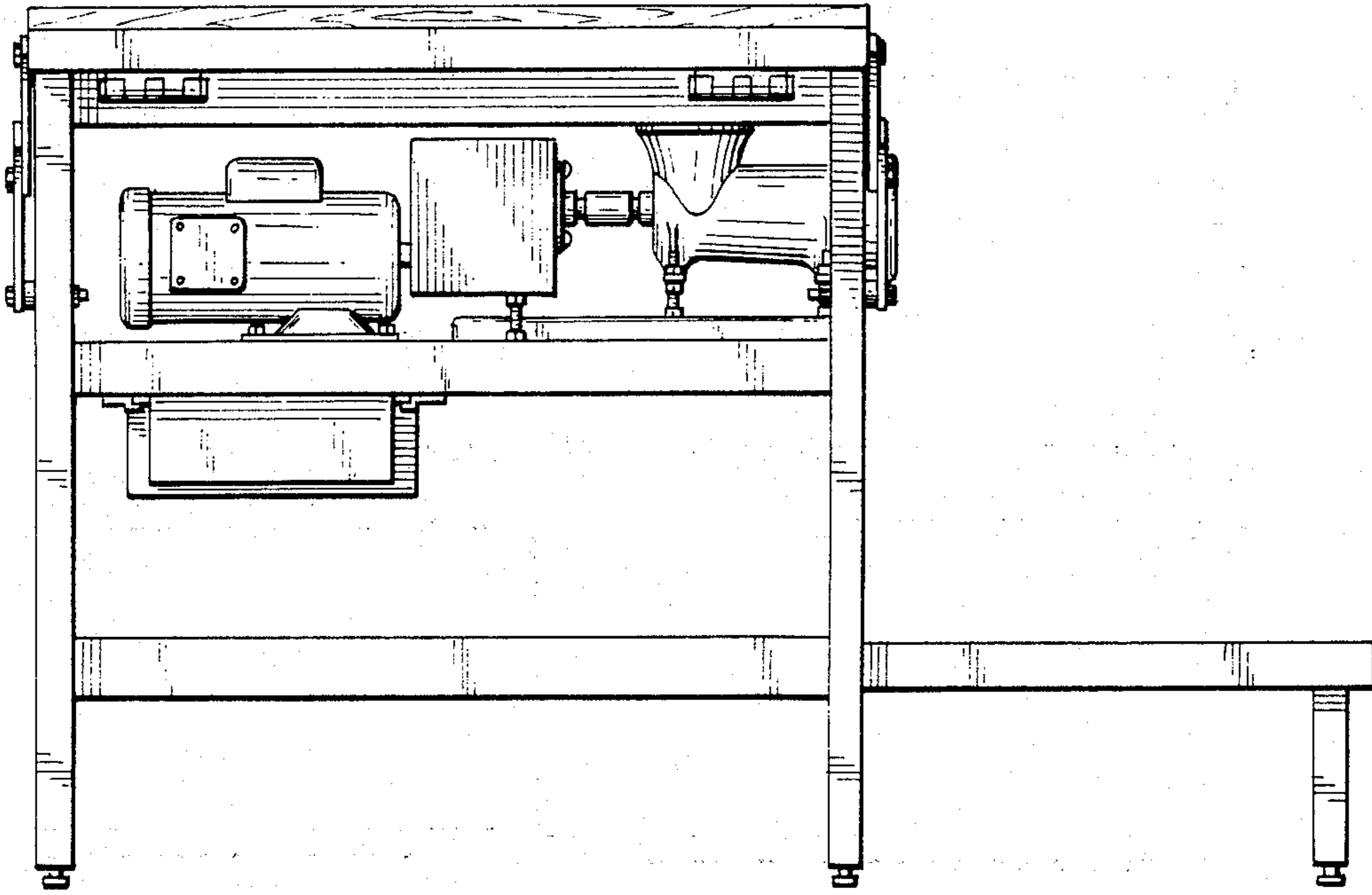

FIG. 4

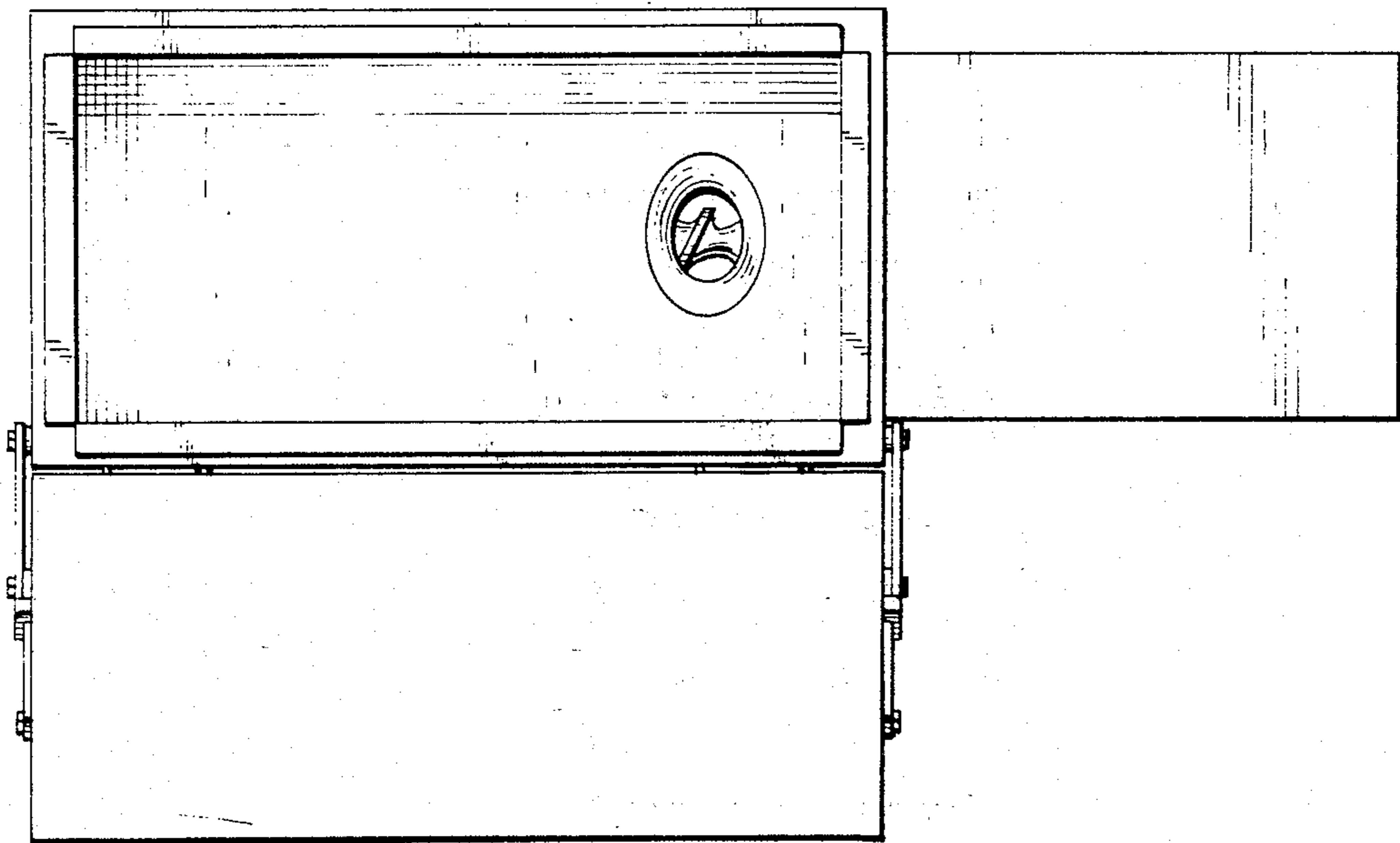

FIG. 5

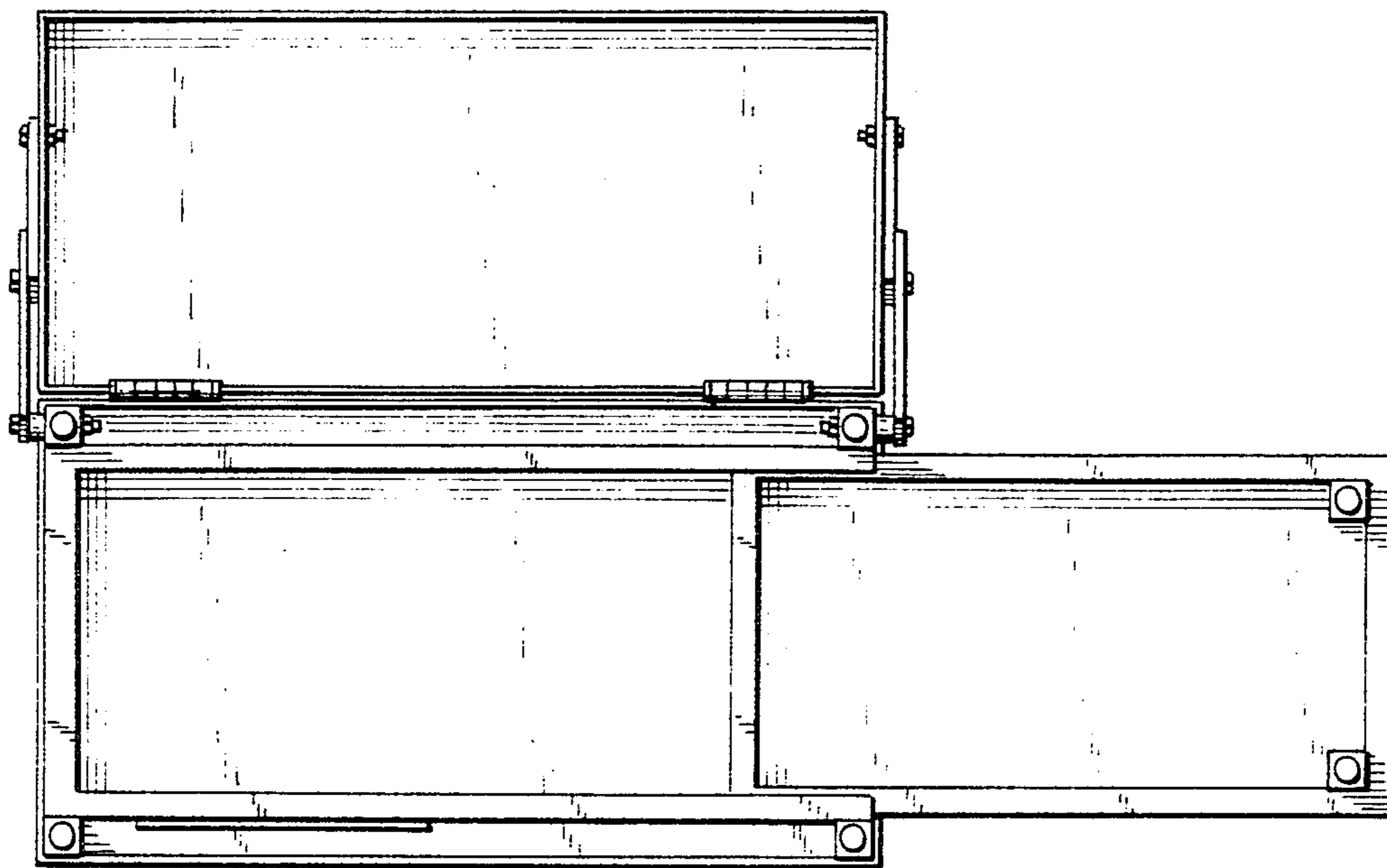

FIG. 6

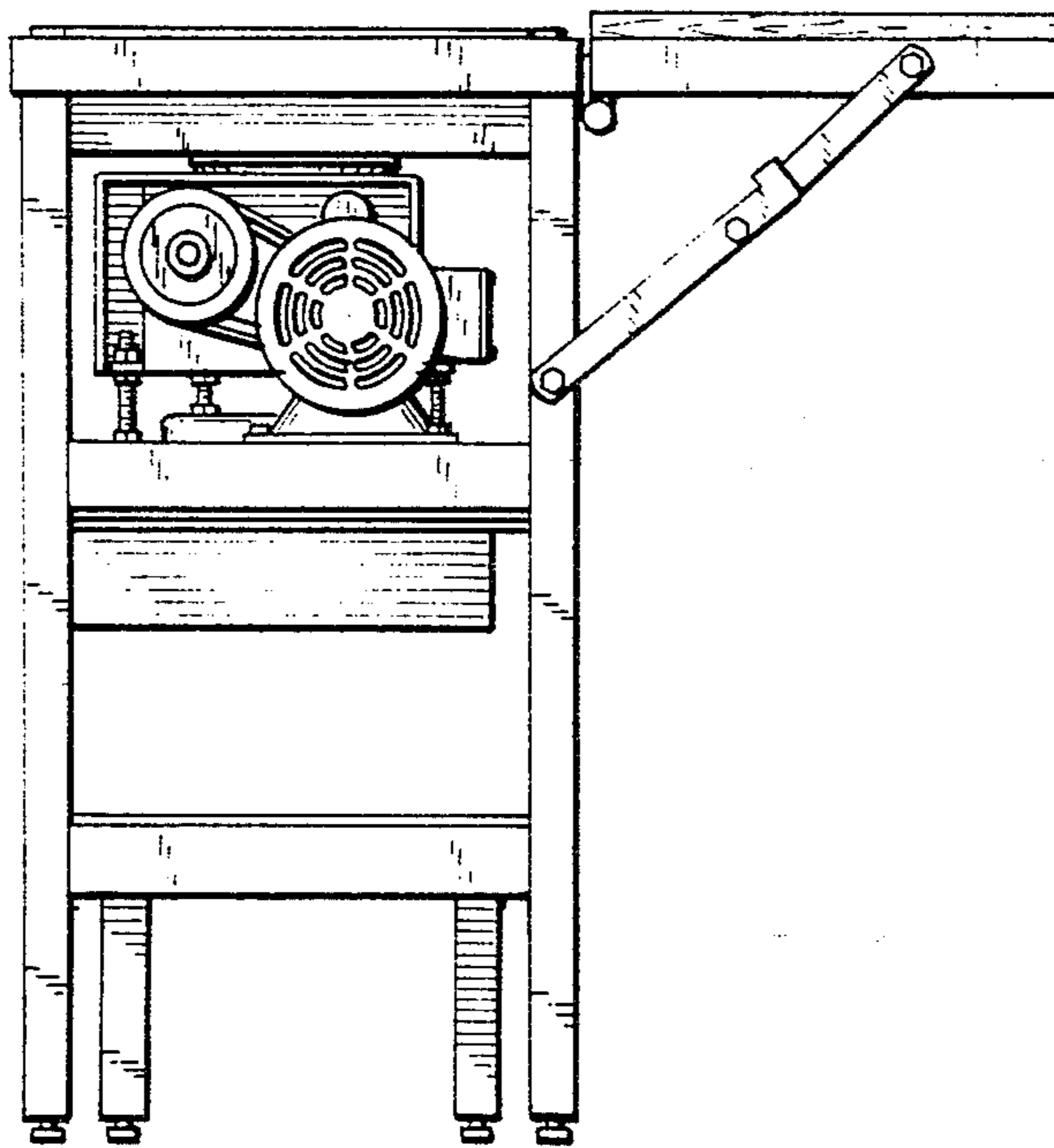

FIG. 7

