

[54] **BOOKSTAND**

4,073,460 2/1978 Dale 248/441.1

[76] **Inventor: Kenneth A. Ellis, R.R. 1, Evansville, Wis. 53536**

[**] **Term: 14 Years**

[21] **Appl. No.: 513,345**

[22] **Filed: Jul. 13, 1983**

[52] **U.S. Cl. D6/475; D6/407**

[58] **Field of Search D6/406, 407, 419, 420, D6/449, 475; 211/42; 248/441.1, 460**

[56] **References Cited**

U.S. PATENT DOCUMENTS

D. 164,452	9/1951	Schiffer	D6/475
D. 186,672	11/1959	Gilruth	D6/475
D. 243,042	1/1977	Dorn	D6/407
D. 253,625	12/1979	Davis	D6/449
1,829,455	10/1931	Riley	248/460
4,002,240	1/1977	Dorn	211/42

OTHER PUBLICATIONS

The Country Gourmet, p. 28, Book Keeper, Item #5849.

Primary Examiner—Carmen H. Vales

Attorney, Agent, or Firm—Isaksen, Lathrop, Esch, Hart & Clark

[57] **CLAIM**

The ornamental design for a bookstand, as shown and described.

DESCRIPTION

FIG. 1 is a perspective view of a bookstand showing my new design;

FIG. 2 is a front elevational view thereof;

FIG. 3 is a top plan view thereof;

FIG. 4 is a bottom plan view thereof.

FIG. 5 is a left side elevational view thereof; and

FIG. 6 is a right side elevational view thereof.

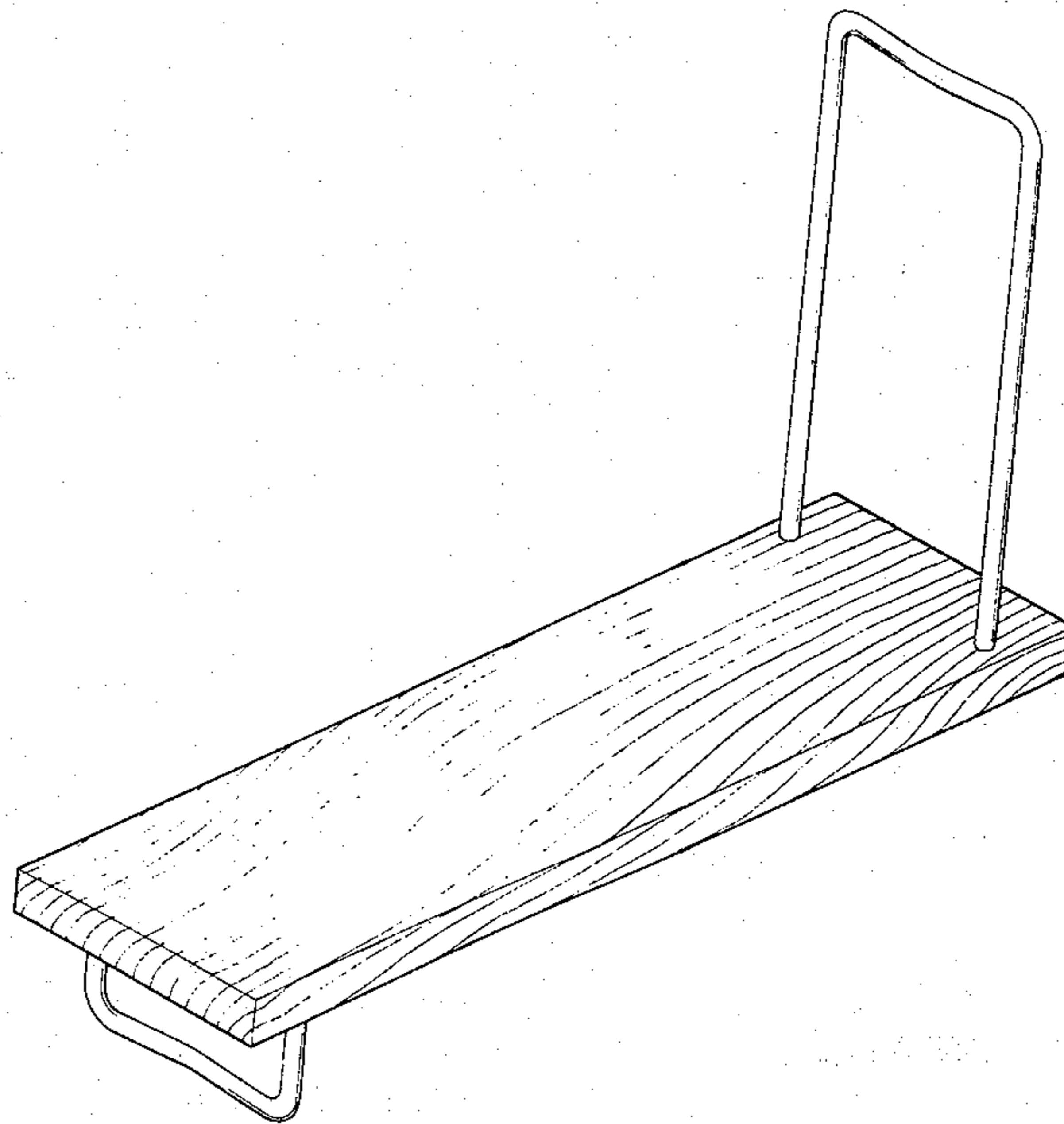

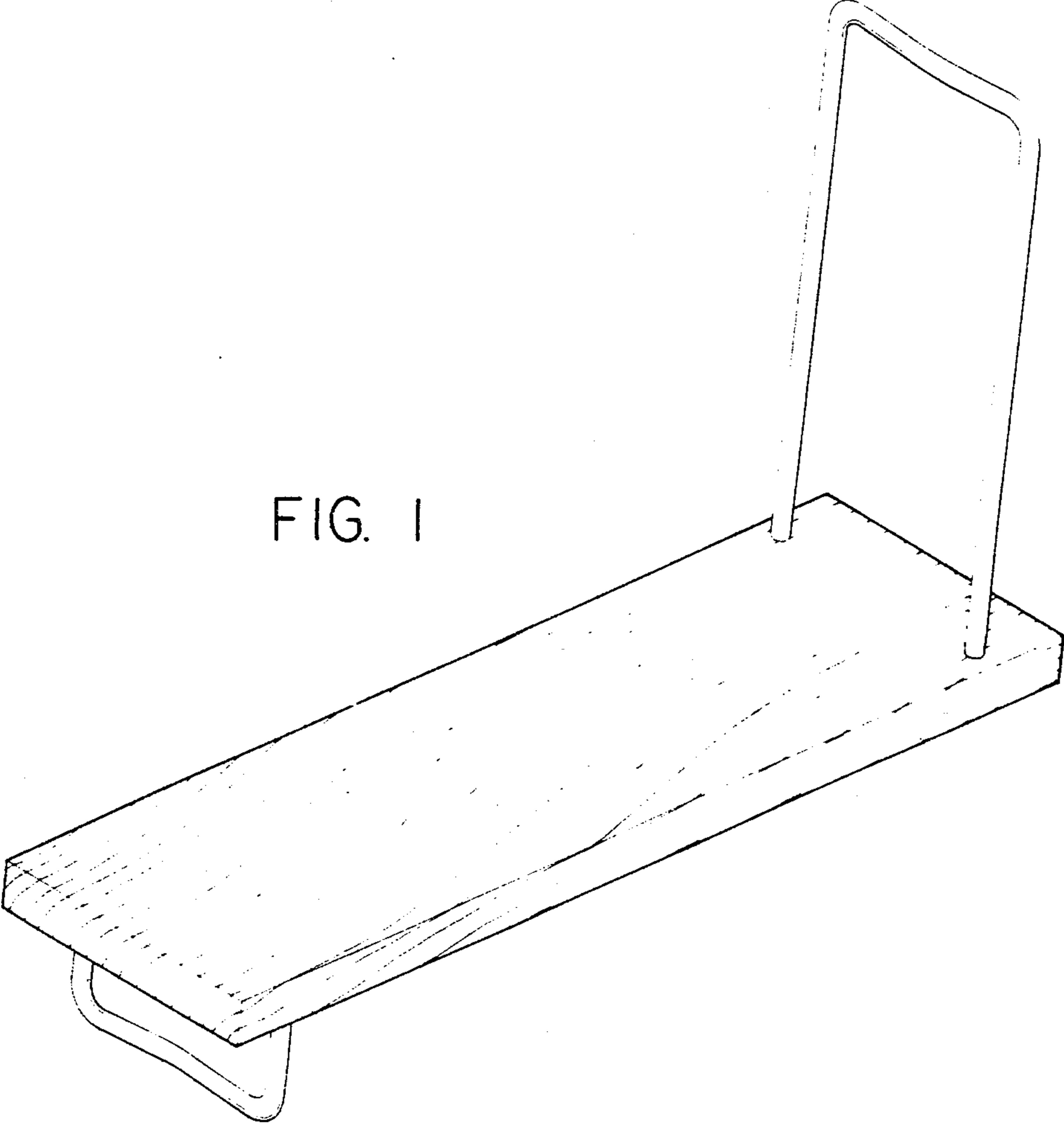

FIG. 1

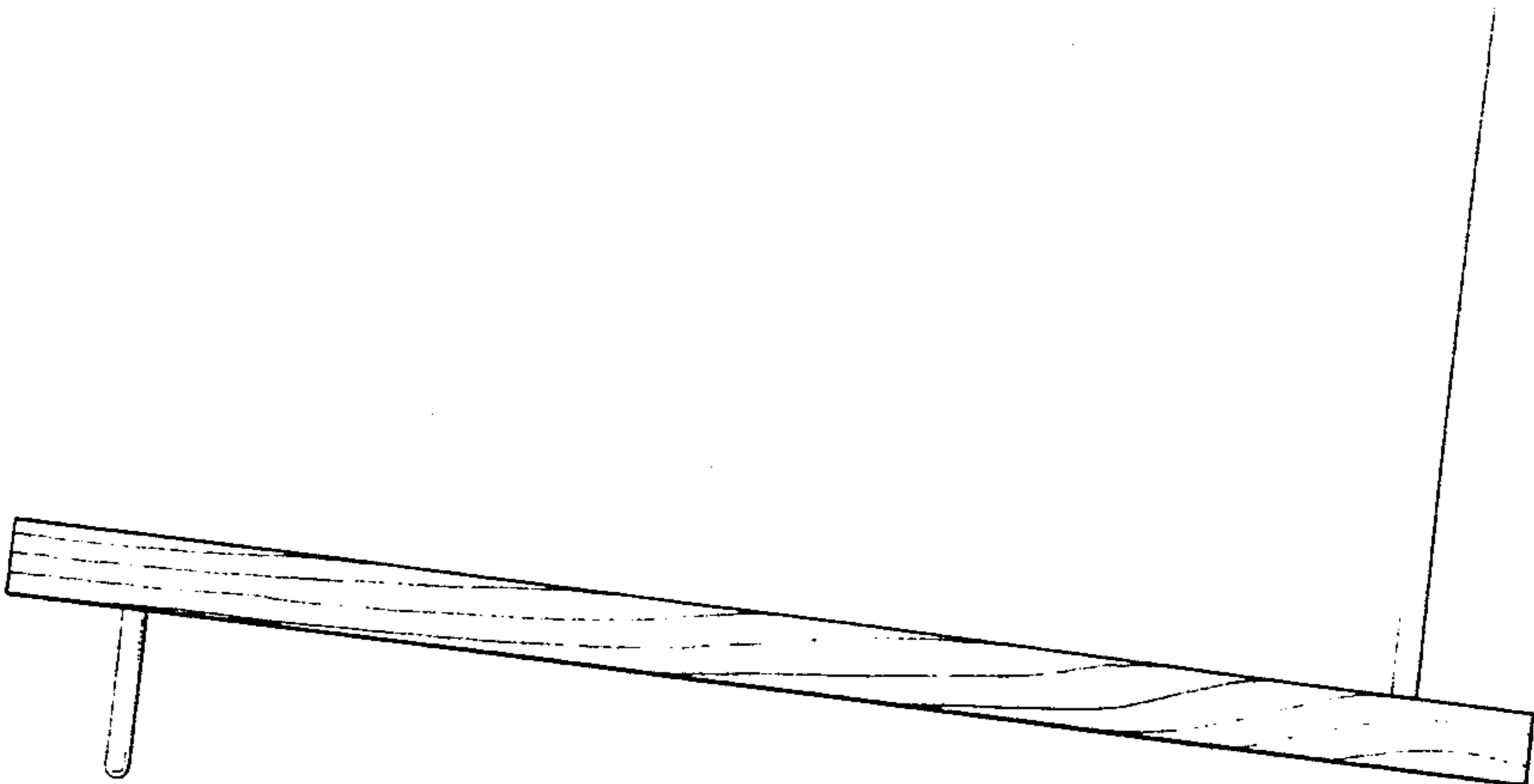

FIG. 2

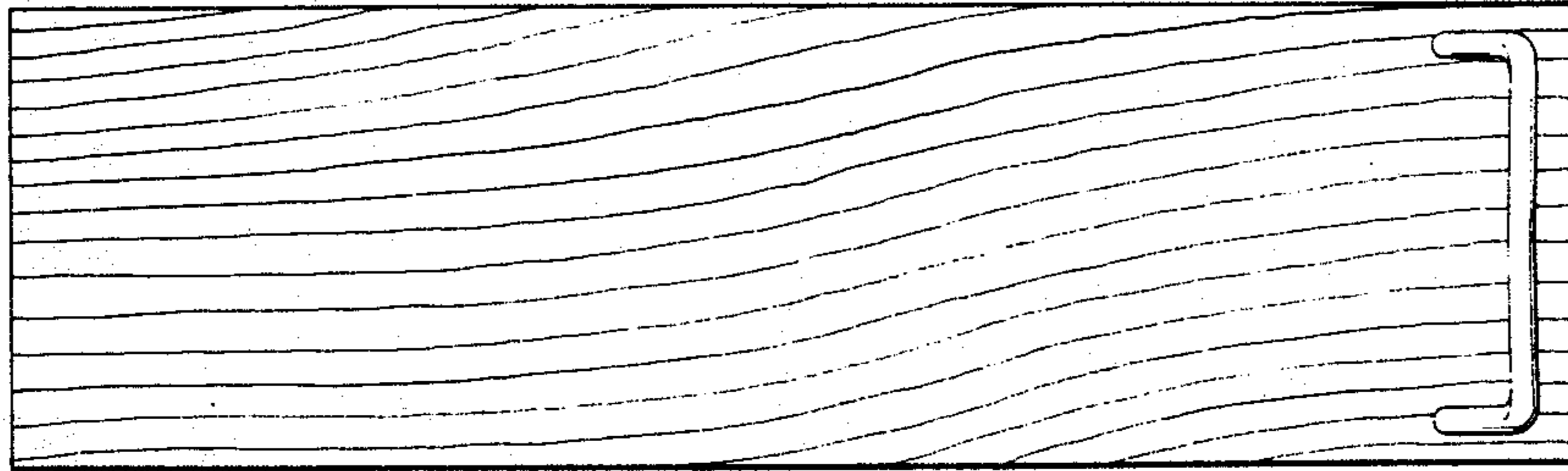

FIG. 3

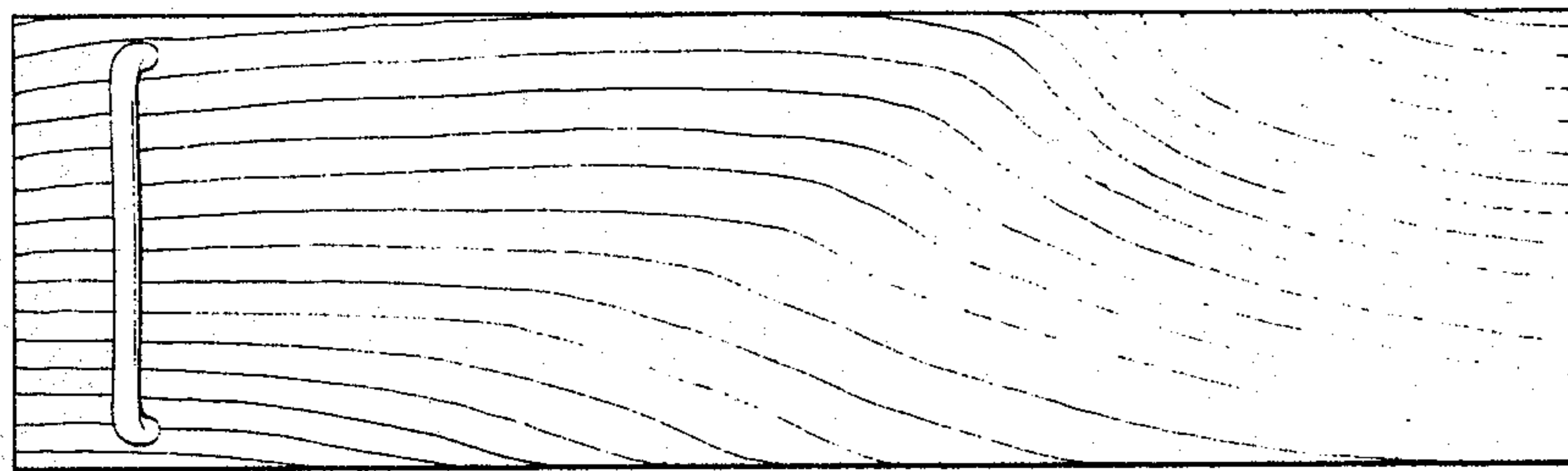

FIG. 4

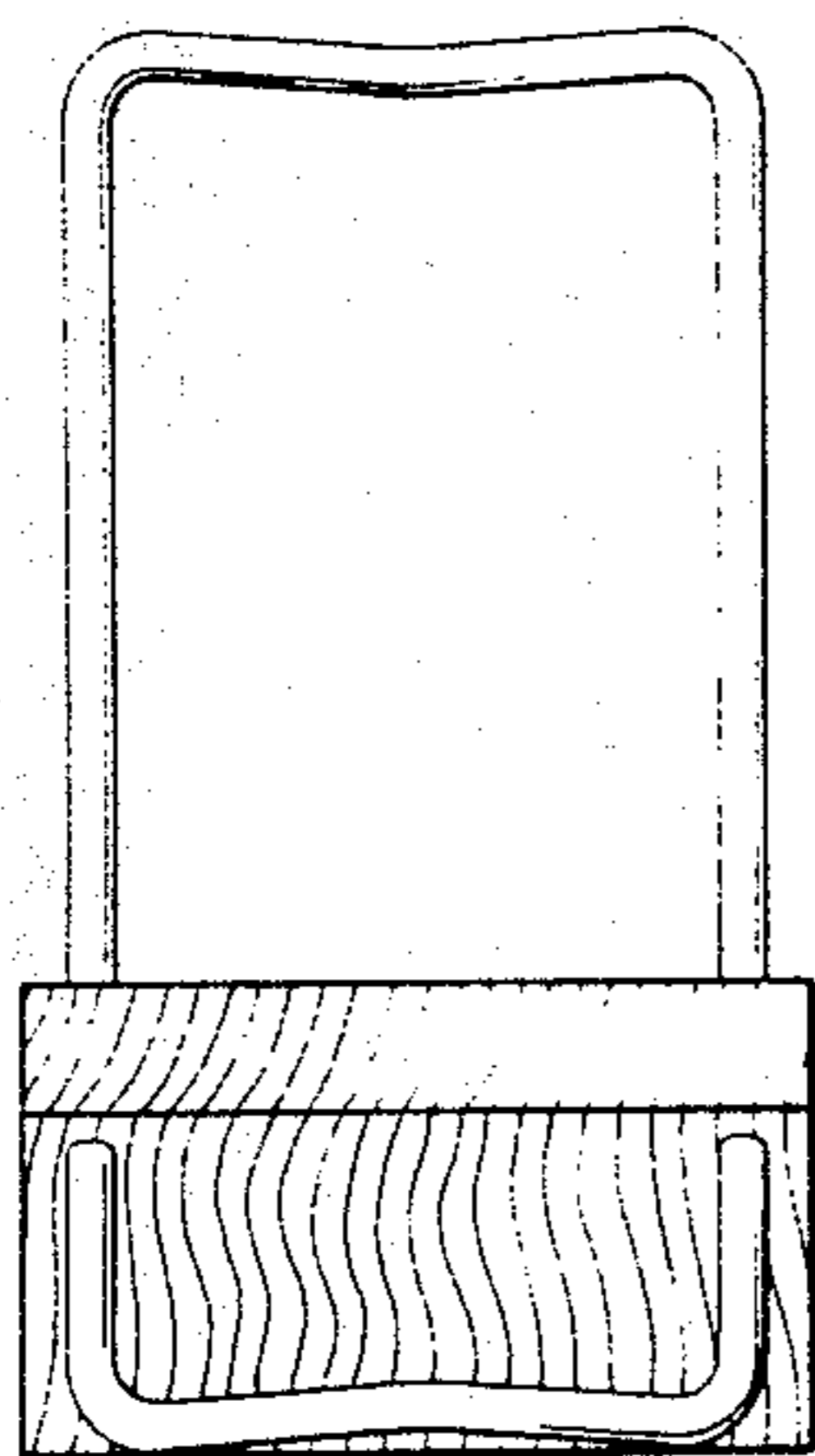

FIG. 5

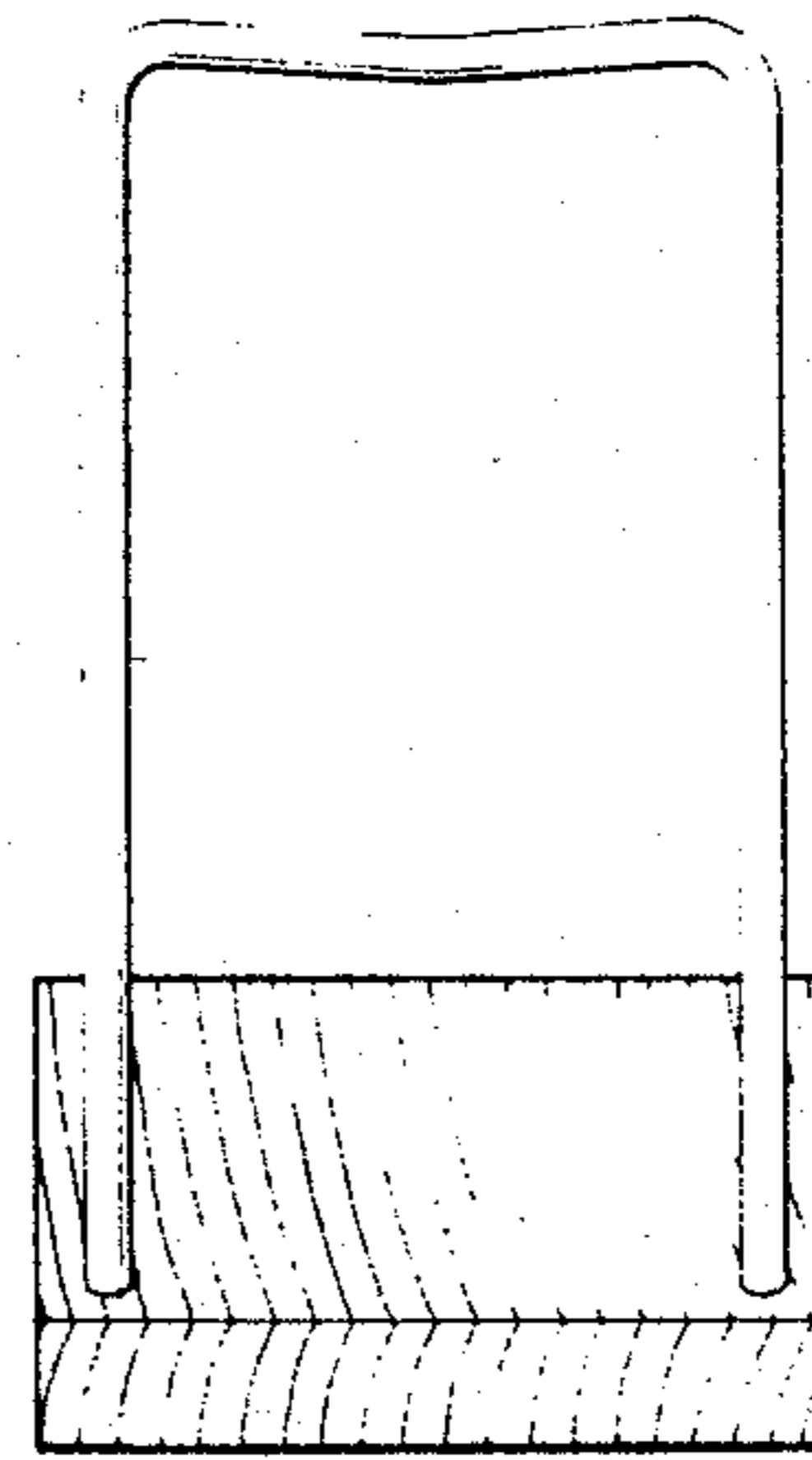

FIG. 6