

[54] COMBINED RECHARGEABLE FLASHLIGHT AND RECHARGING STAND THEREFOR

3,281,637 10/1966 Hultquist 362/183 X
3,517,185 6/1970 Moore et al. 362/183

[75] Inventor: Alain Verdier, Sainte-Foy-Les-Lyon, France

Primary Examiner—Susan J. Lucas
Attorney, Agent, or Firm—Finnegan, Henderson, Farabow, Garrett & Dunner

[73] Assignee: Black & Decker, Inc., Newark, Del.

[57] CLAIM

[**] Term: 14 Years

The ornamental design for a combined rechargeable flashlight and recharging stand therefor, as shown and described.

[21] Appl. No.: 517,417

DESCRIPTION

[22] Filed: Jul. 26, 1983

[30] Foreign Application Priority Data

Jan. 26, 1983 [FR] France 830247

[52] U.S. Cl. D26/46; D13/6

[58] Field of Search D26/37-50,
D26/51; 362/157, 158, 183-208; D13/5, 6;
320/2

FIG. 1 is a perspective view of a combined rechargeable flashlight and recharging stand therefor showing my new design;

FIGS. 2-7 are, respectively, rear, top, bottom, left side, right side and front views of the rechargeable flashlight, the recharging stand being omitted for purposes of disclosure;

FIGS. 8, 9, 10, 11 and 12 are, respectively, rear, top, left side, right side and front views of the combined rechargeable flashlight and recharging stand as shown in FIG. 1; and

FIG. 13 is a perspective view of the recharging stand, the rechargeable flashlight being omitted for purposes of disclosure.

[56] References Cited

U.S. PATENT DOCUMENTS

D. 205,679 9/1966 Moore et al. D26/46
D. 272,476 1/1984 McCloskey et al. D26/46
3,183,891 5/1965 MacDonald D13/6 X

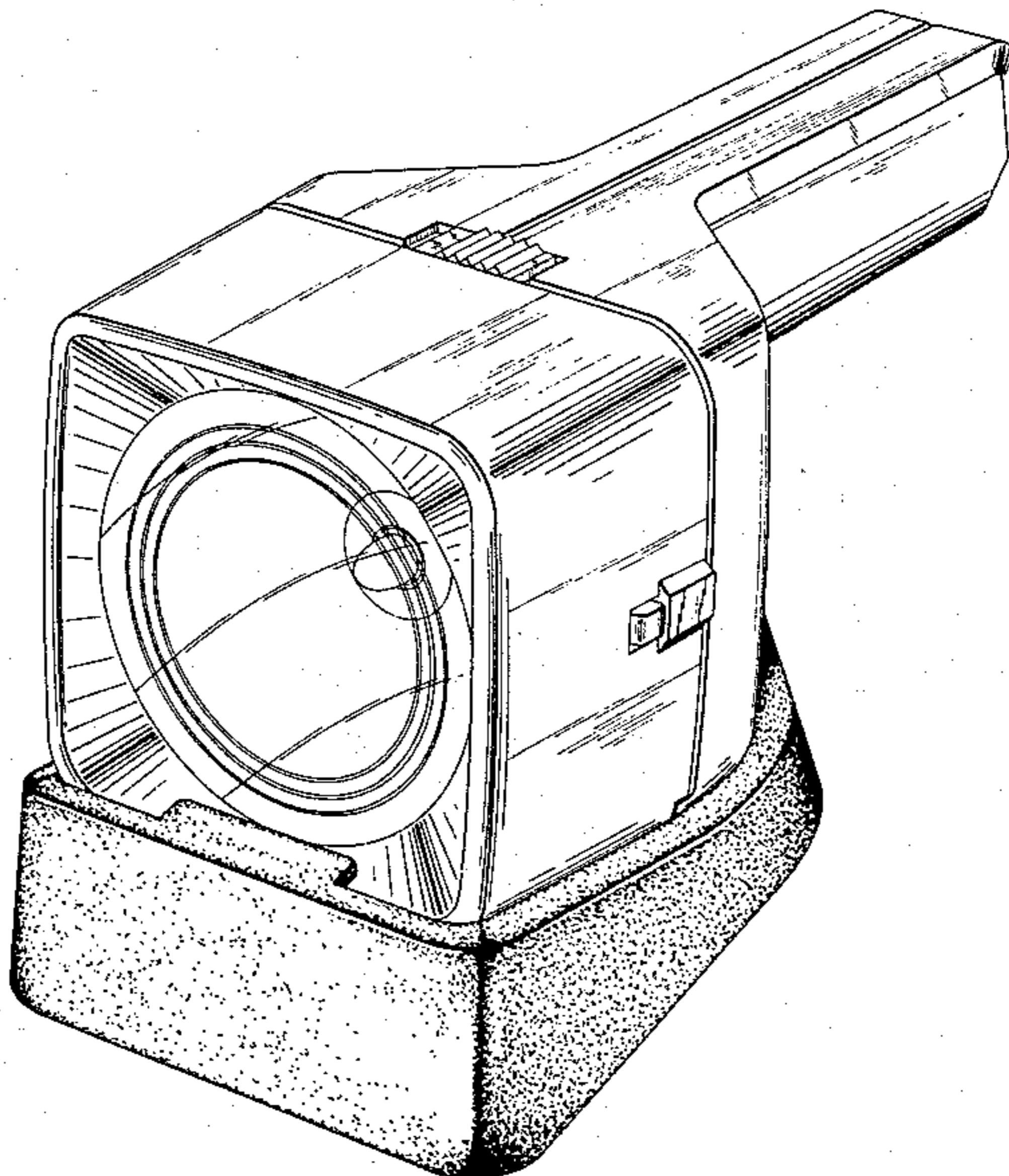

Fig. 1

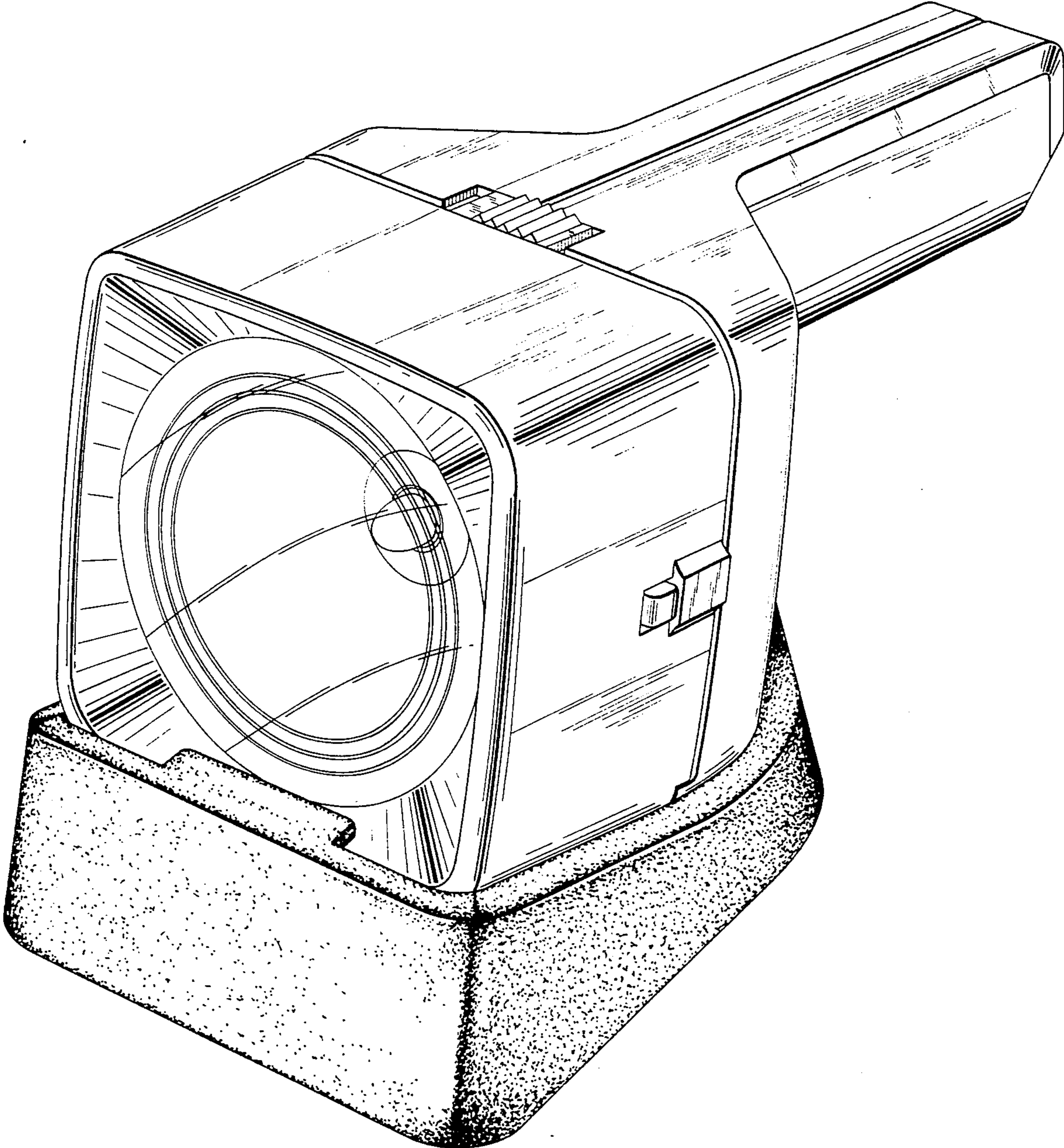

FIG. 1

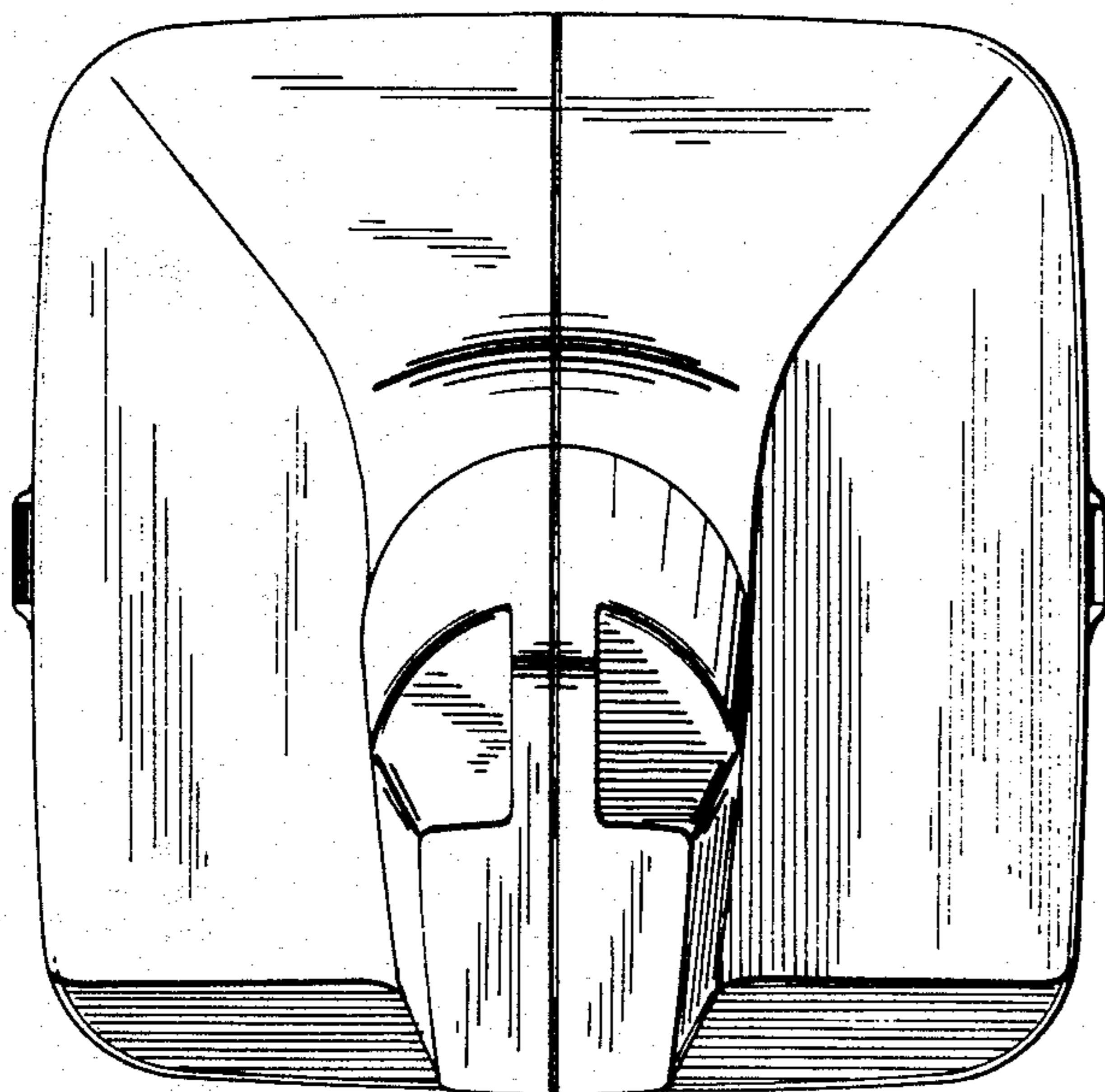
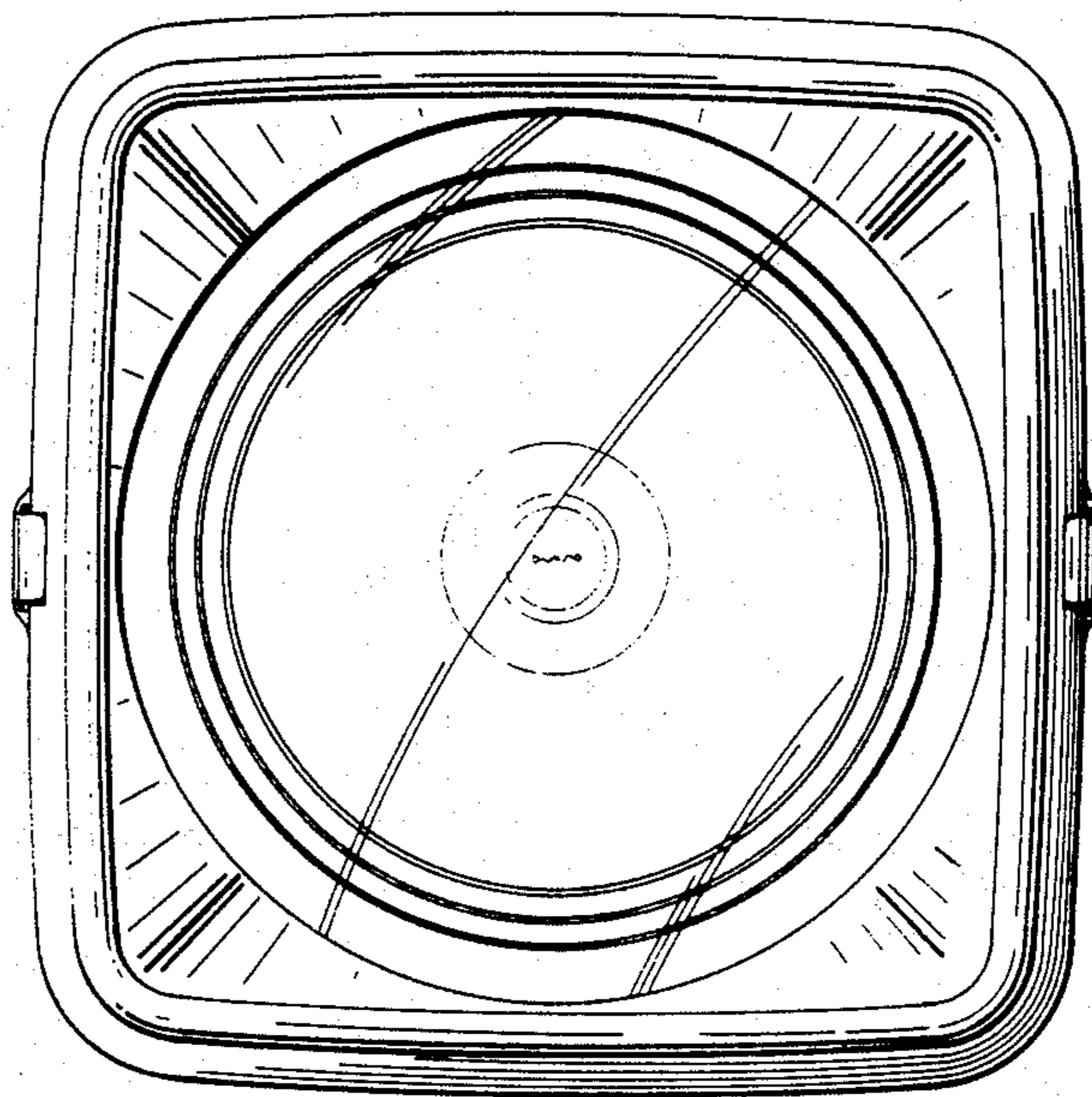

FIG. 2

FIG. 3

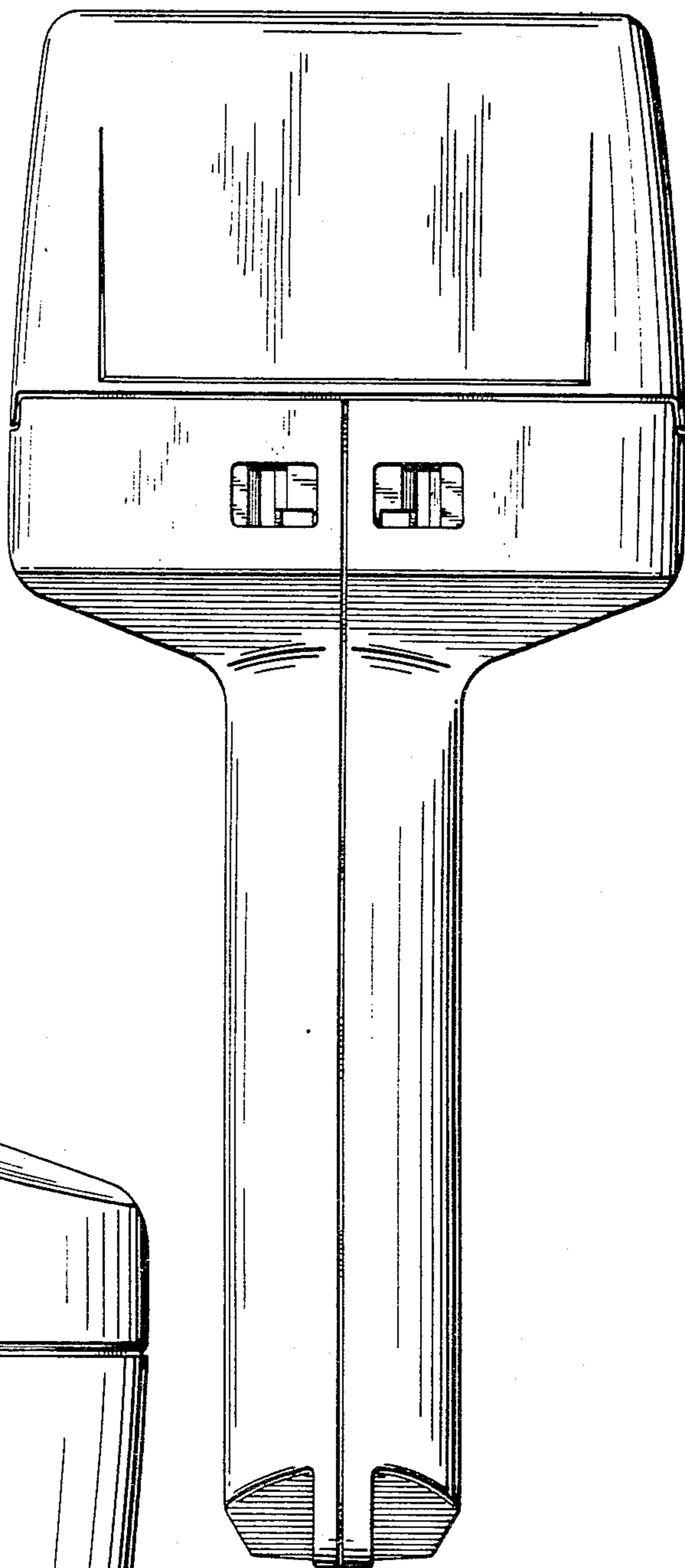
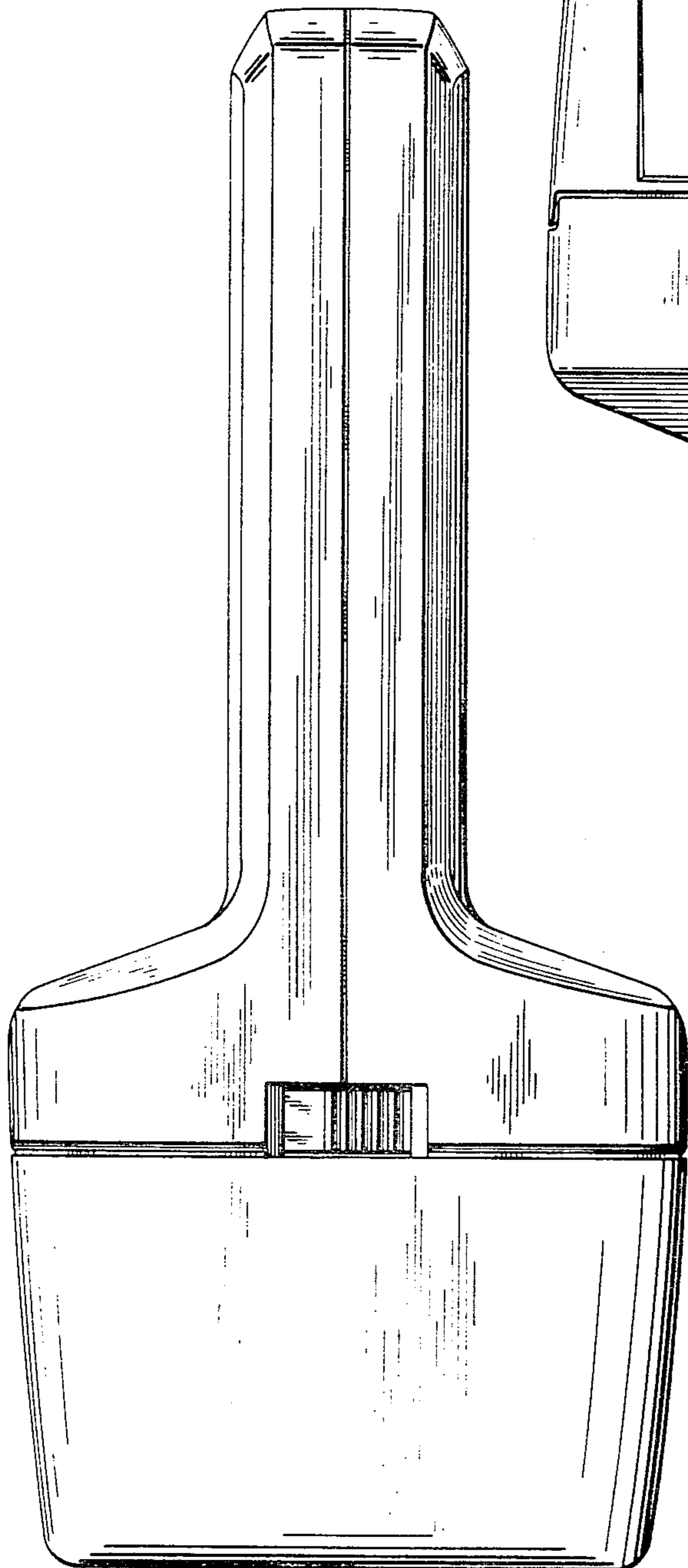

FIG. 4

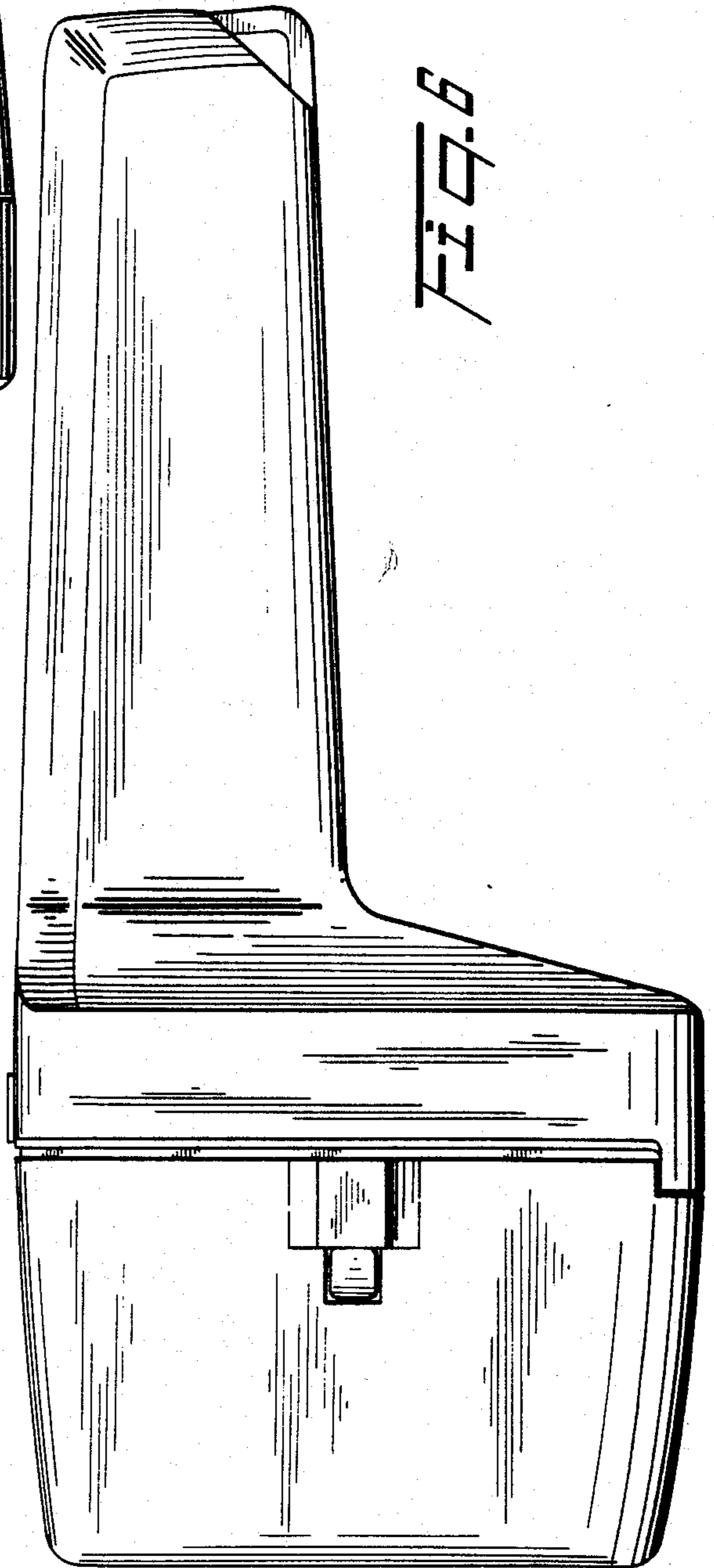
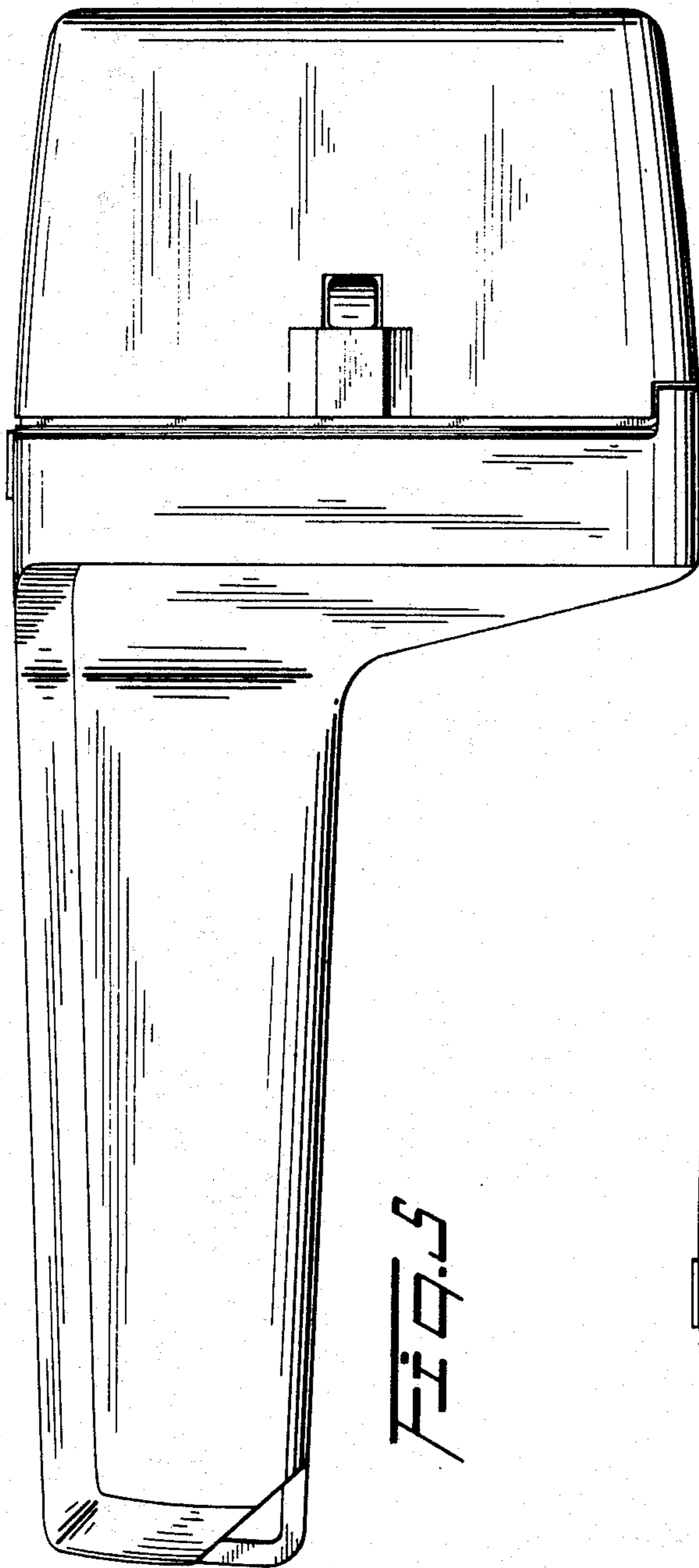

Fig. 12

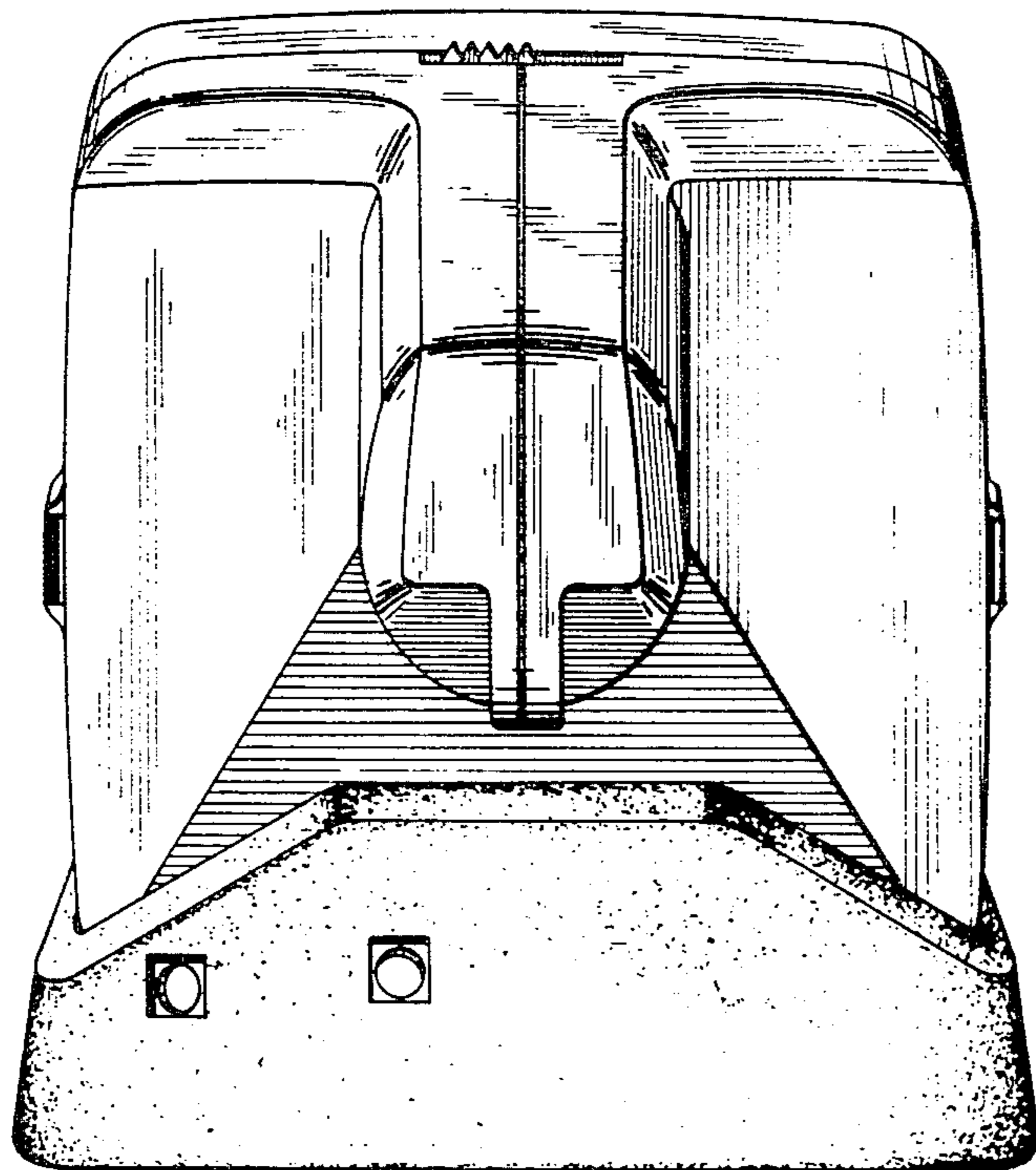
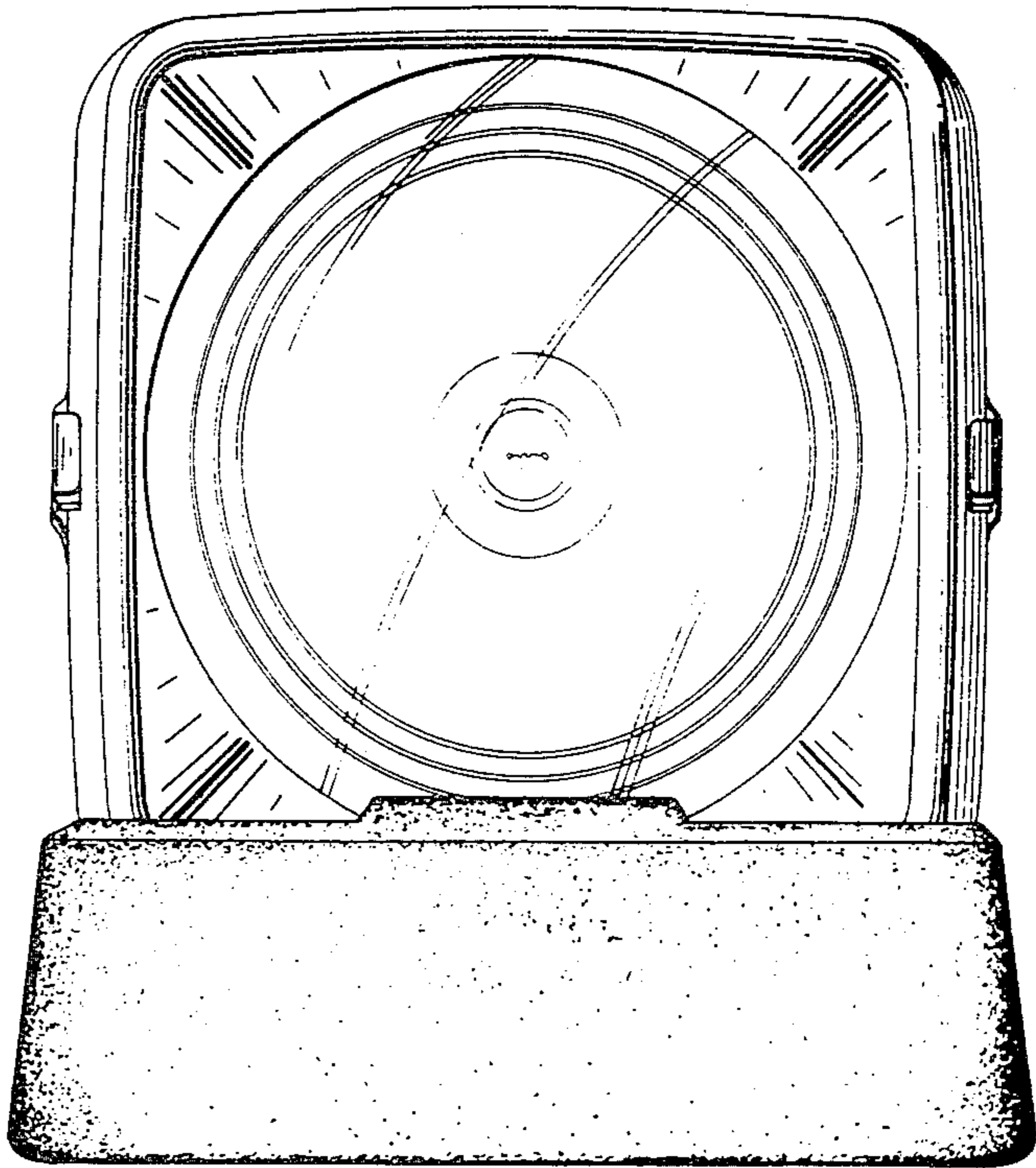

Fig. 6

FIG. 9

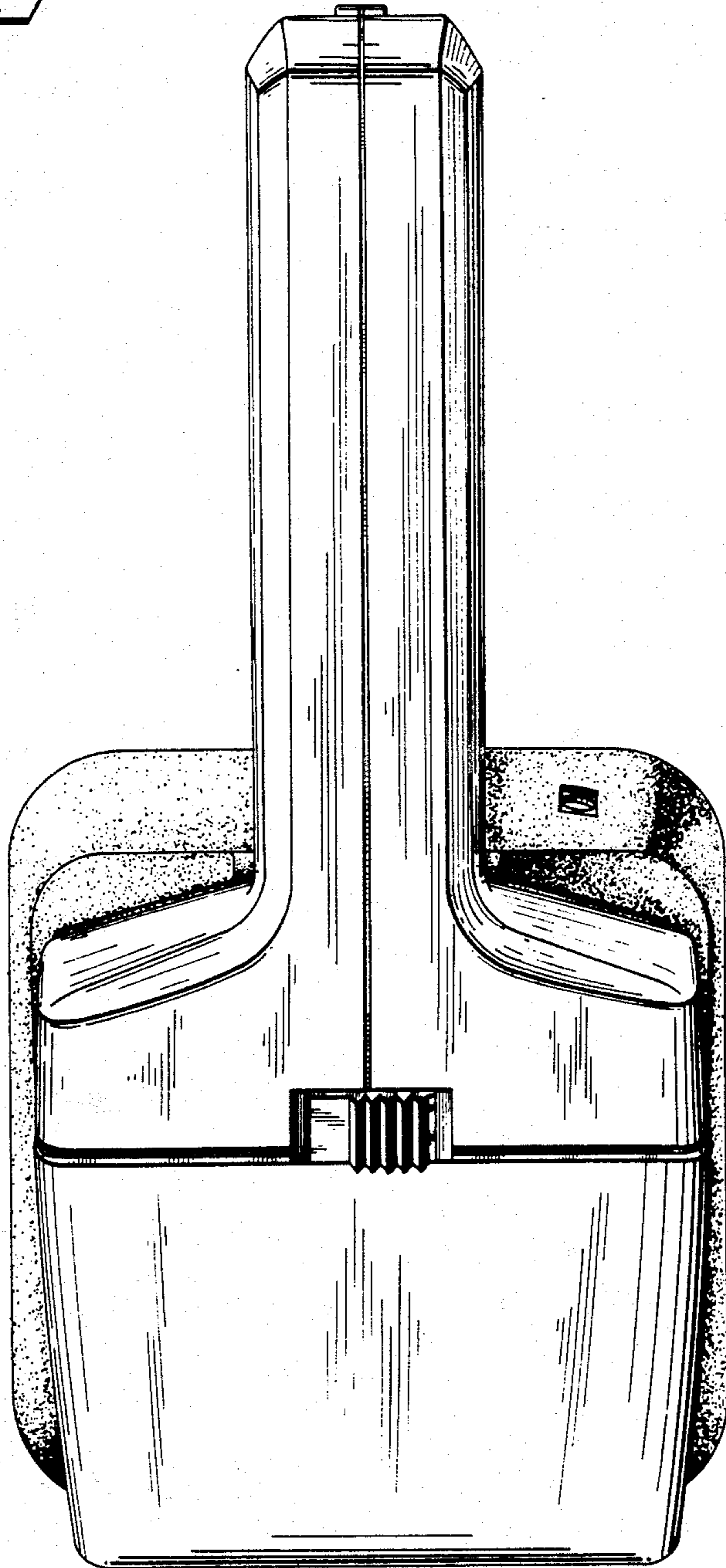
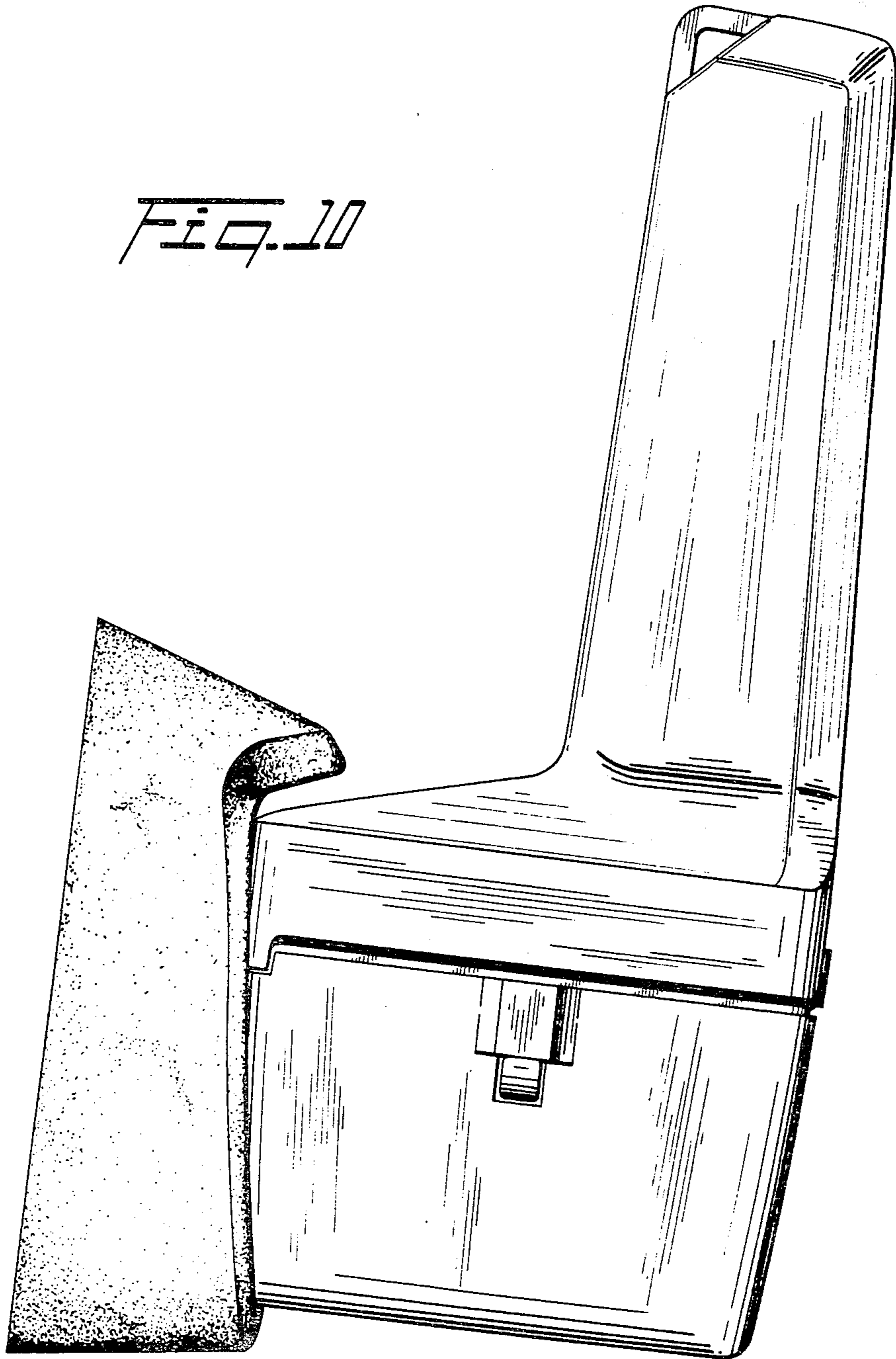

Fig. 10



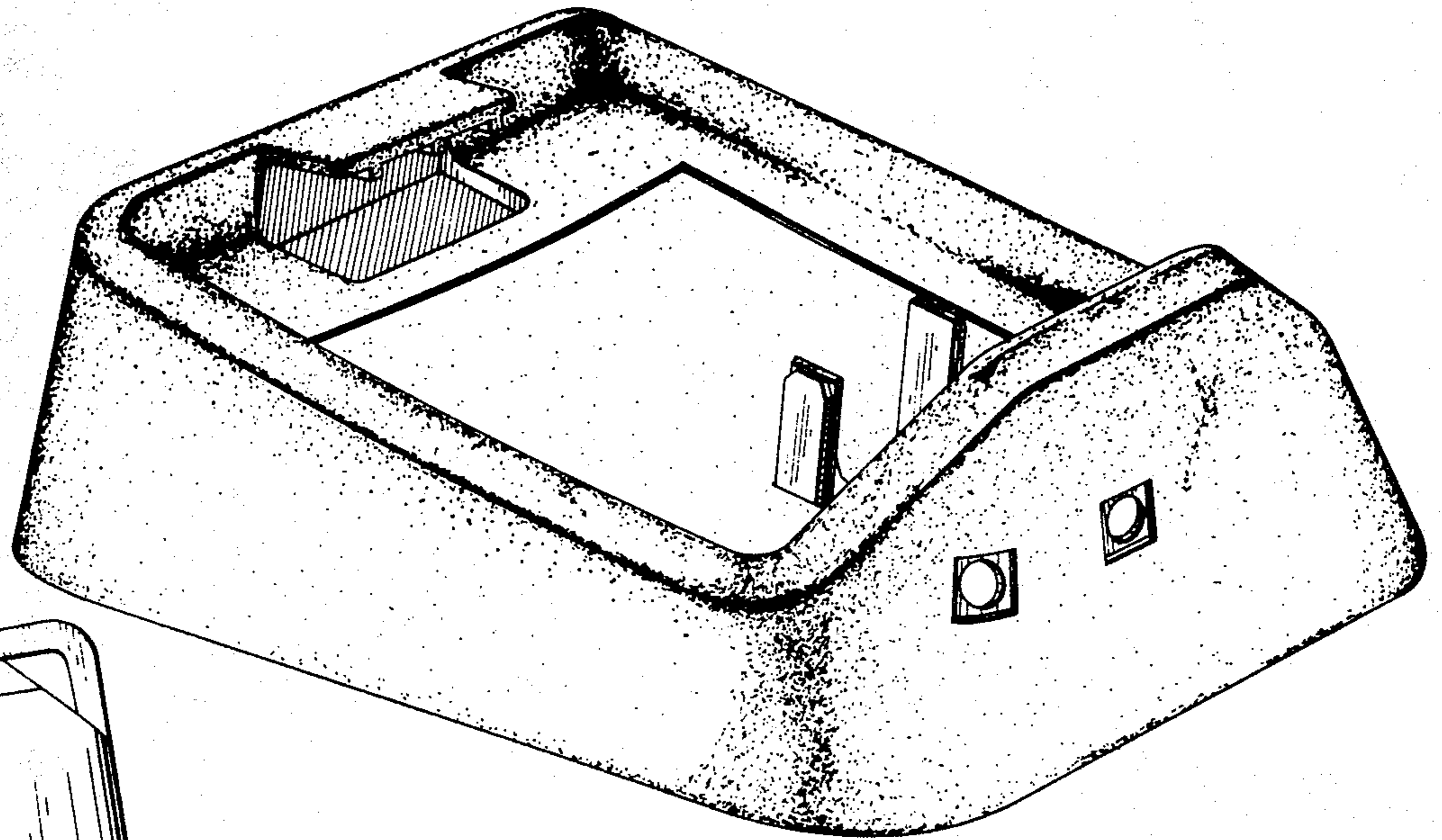

Fig. 13

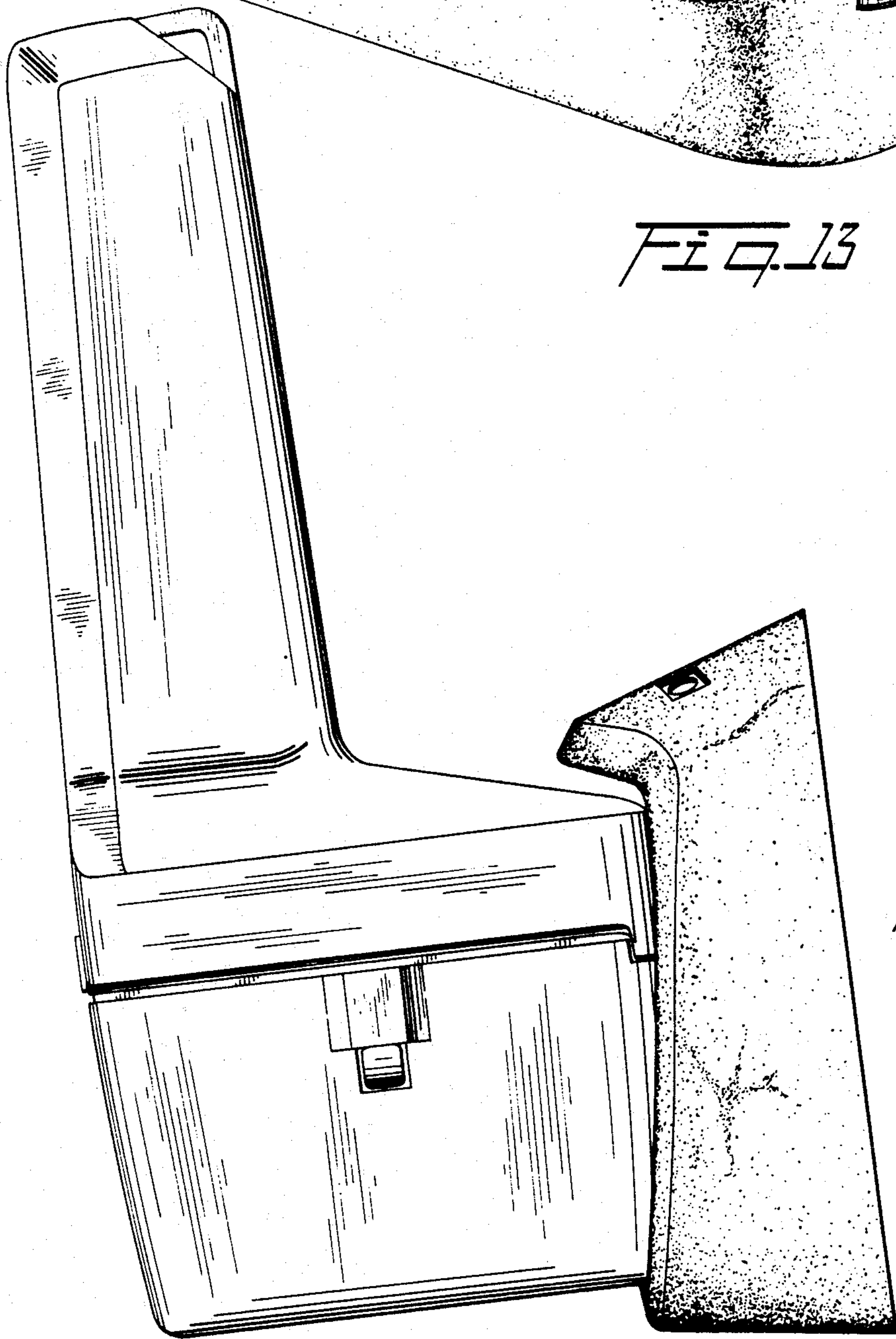

Fig. 11