

[54] HINGED CONTAINER WITH COMPONENT INSERTS

4,006,818 2/1977 Wannyn 206/564

[75] Inventors: Robert D. Holewinski, Lakehurst; Leslie Hamilton, Trenton; William J. Blatherwick, Hamilton Square, all of N.J.

Primary Examiner—A. Hugo Word
Assistant Examiner—Stella Reid
Attorney, Agent, or Firm—Charles J. Metz

[73] Assignee: Johnson & Johnson Dental Products Co., East Windsor, N.J.

[57] CLAIM

The ornamental design for a hinged container with component inserts, as shown and described.

[**] Term: 14 Years

DESCRIPTION

[21] Appl. No.: 460,974

FIG. 1 is a perspective view of a hinged container with component inserts showing our new design;

[22] Filed: Jan. 26, 1983

FIG. 2 is a view of one side of the container of FIG. 1; FIG. 3 is a front elevational view of the container of FIG. 1;

[52] U.S. Cl. D24/31

FIG. 4 is a rear elevational view of the container of FIG. 1;

[58] Field of Search D24/31, 32; 206/363, 206/364, 366, 370, 562, 563, 564

FIG. 5 is a top plan view of the container of FIG. 1; FIG. 6 is a bottom plan view of the container of FIG. 1; and

[56] References Cited

U.S. PATENT DOCUMENTS

- D. 198,151 5/1964 Folkman D24/31
- D. 221,035 6/1971 Raines D24/31
- 3,013,656 12/1961 Murphy, Jr. 206/370 X
- 3,851,649 12/1974 Villari 206/564 X

FIG. 7 is a perspective view of the container of FIG. 1, showing various articles contained therein.

The broken line showing of the various articles in FIG. 7 is for illustrative purposes only and forms no part of the claimed design.

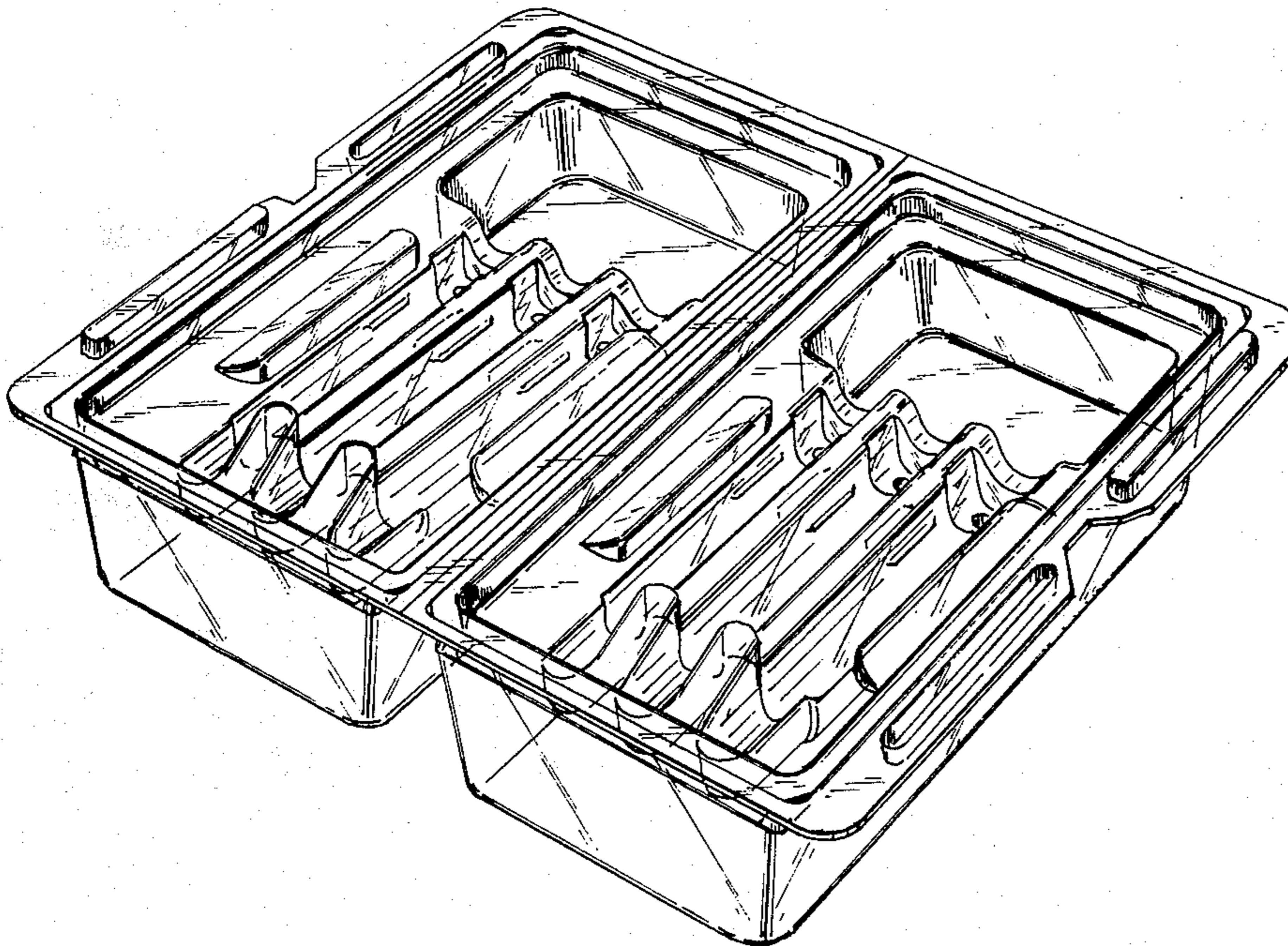

FIG-1

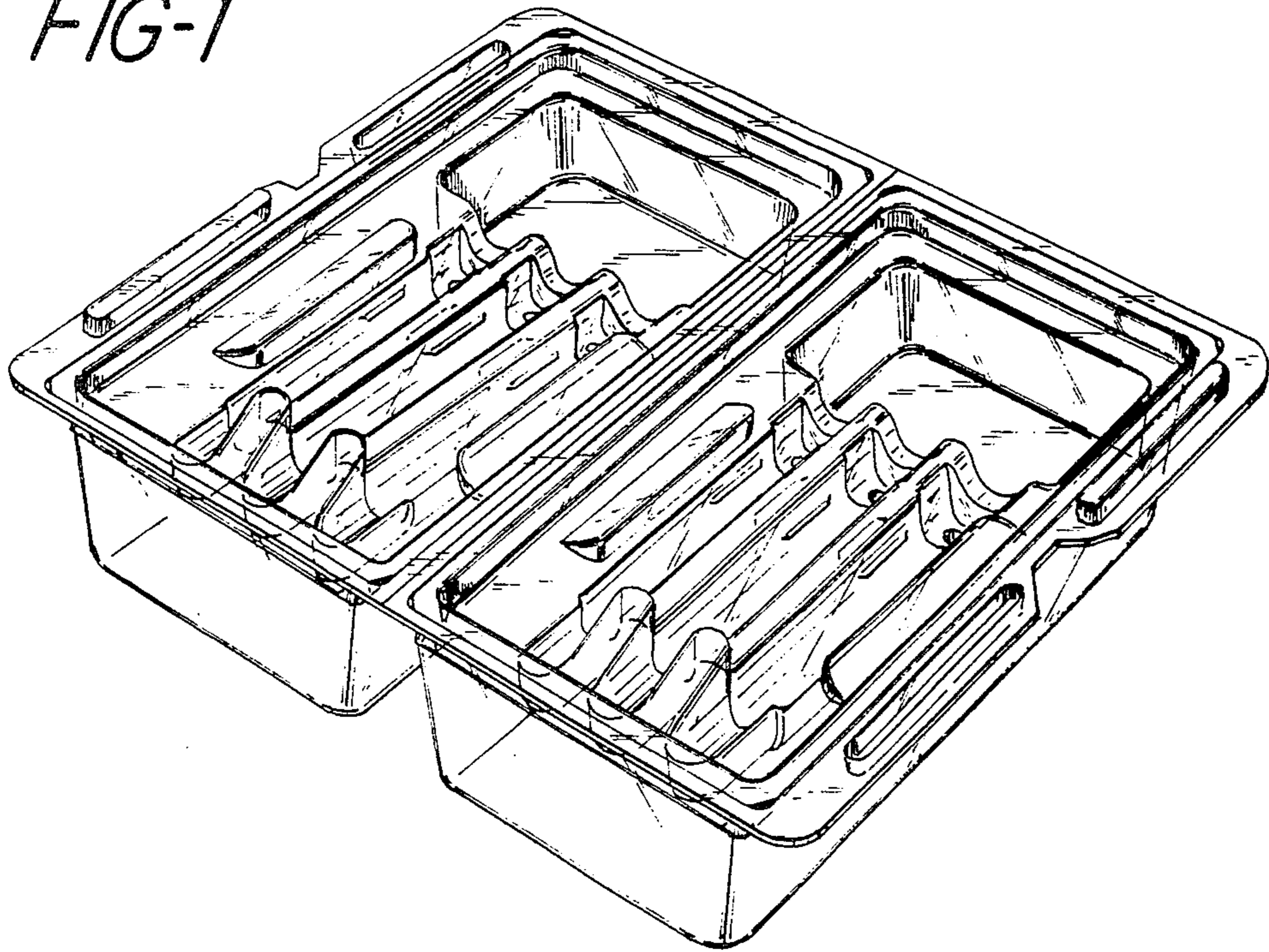

FIG-2

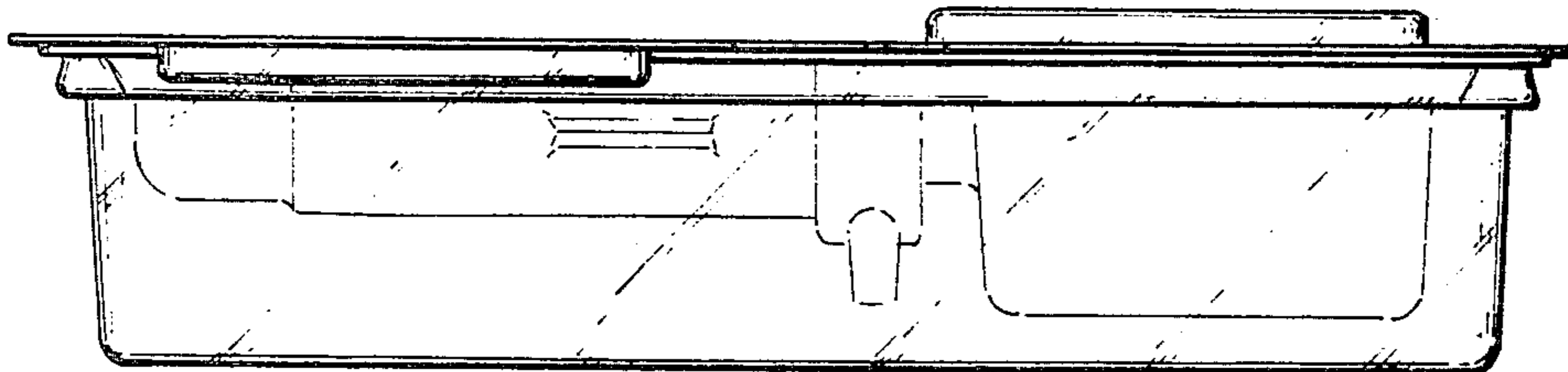

FIG-3

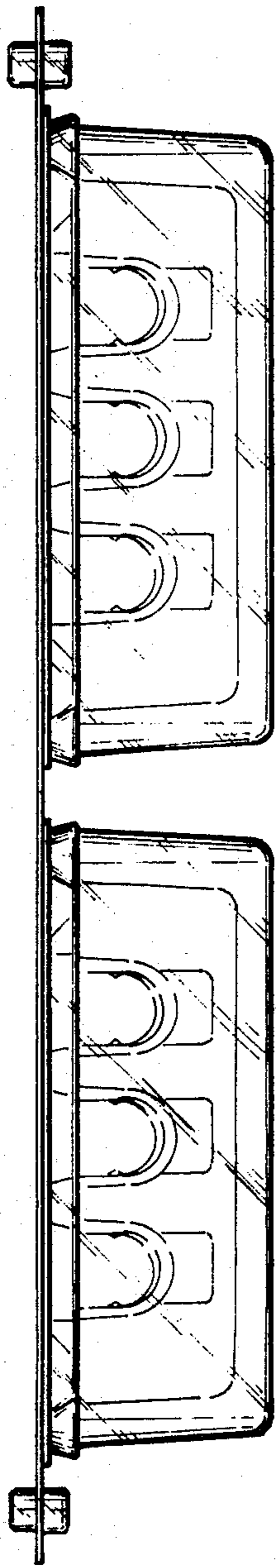
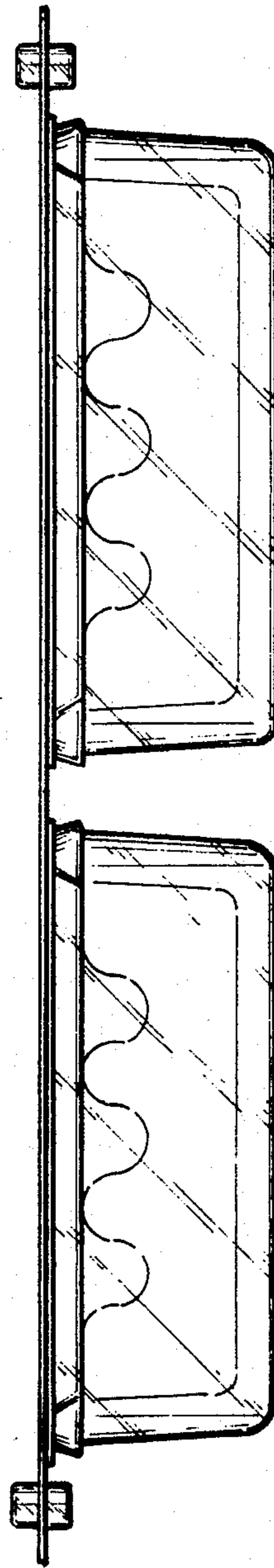

FIG-4



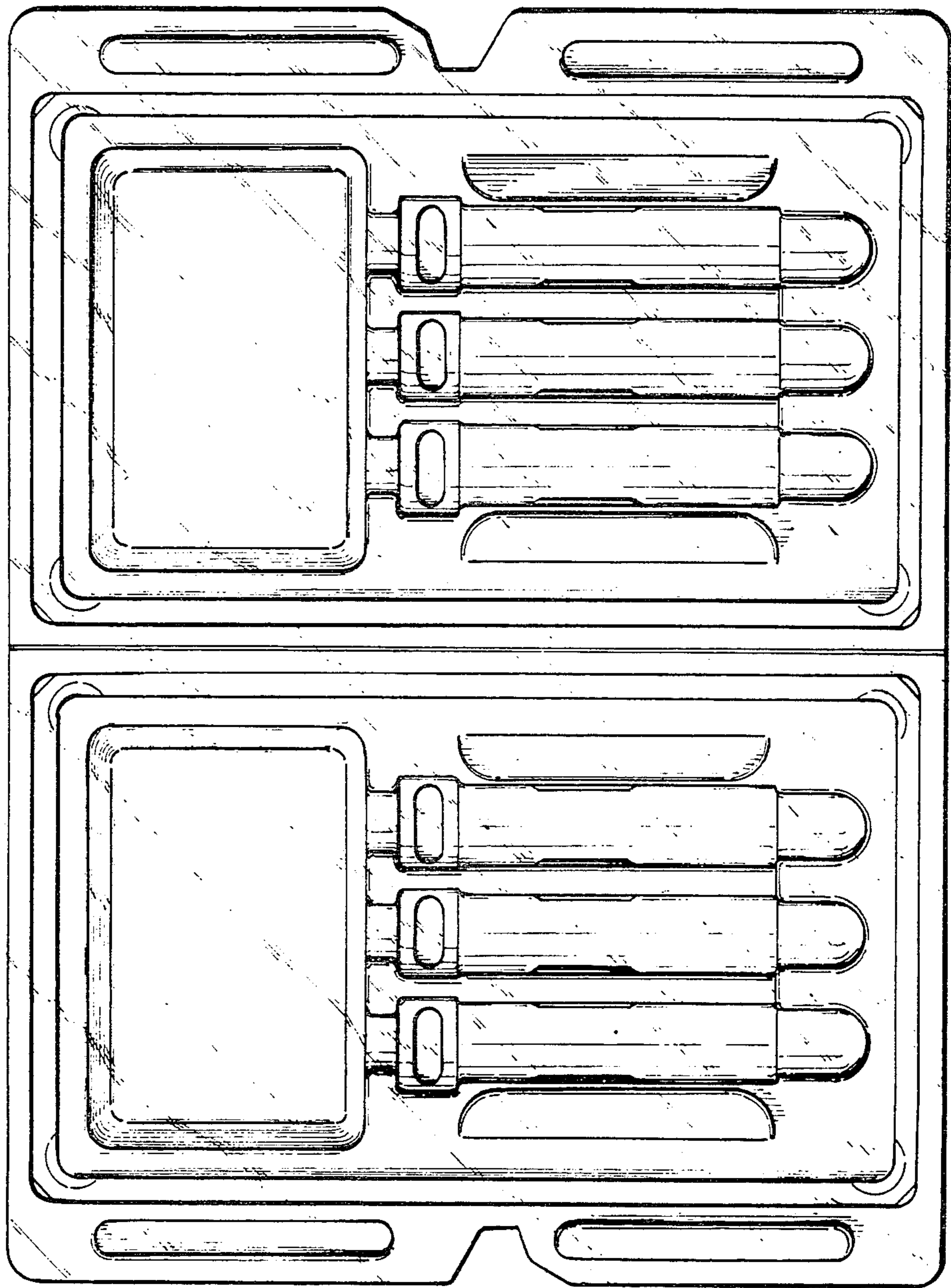

FIG-5

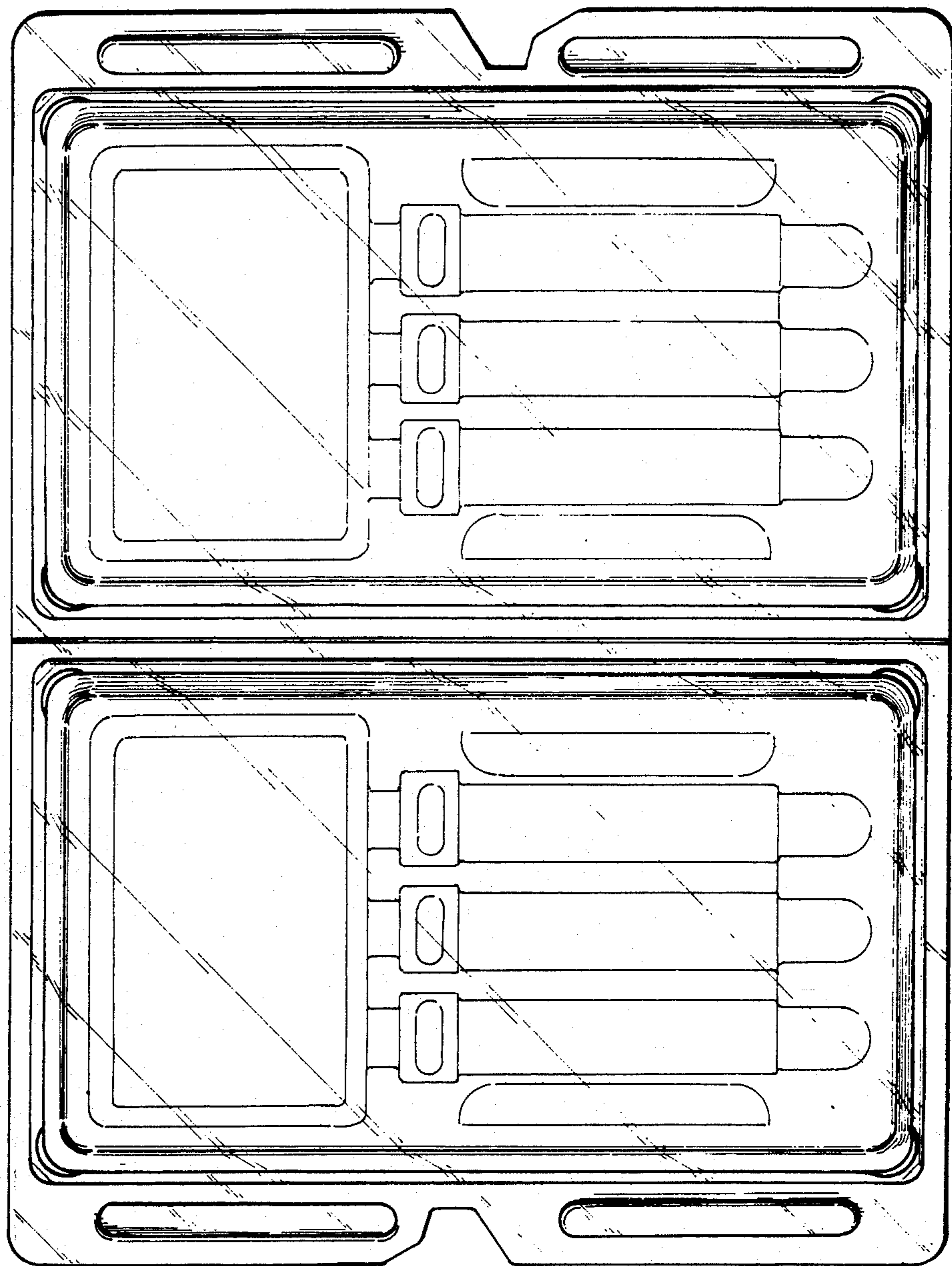

FIG-6

FIG-7

