

[54] GUIDE FOR FEMORAL NECK OSTEOTOMY

[75] Inventor: Robert V. Kenna, Hackensack, N.J.

[73] Assignee: Howmedica, Inc., New York, N.Y.

[**] Term: 14 Years

[21] Appl. No.: 485,536

[22] Filed: Apr. 15, 1983

[52] U.S. Cl. D24/26

[58] Field of Search D24/8, 26, 28, 33;
128/92 E, 92 EB, 303 R, 305

[56] References Cited

U.S. PATENT DOCUMENTS

D. 272,853	2/1984	Buechel et al.	D24/26
D. 272,854	2/1984	Witte et al.	D24/26
2,547,571	4/1951	Ettinger	128/92 EB
4,349,018	9/1982	Chambers	128/92 E

OTHER PUBLICATIONS

Zimmer-Medical/Surgical Products, ©1981, p. A 154, Items No. 5320-10, 5230-33.

Primary Examiner—A. Hugo Word

Assistant Examiner—Stella Reid

Attorney, Agent, or Firm—Charles J. Knuth; Peter C. Richardson; Harold W. Ordway

[57] CLAIM

The ornamental design for a guide for femoral neck osteotomy, as shown and described.

DESCRIPTION

FIG. 1 is a perspective view of a guide for femoral neck osteotomy showing my new design; FIG. 2 is a front elevational view thereof; FIG. 3 is a right side elevational view thereof; FIG. 4 is a top plan view thereof; FIG. 5 is a rear elevational view thereof; FIG. 6 is a left side elevational view thereof; and FIG. 7 is a bottom plan view thereof.

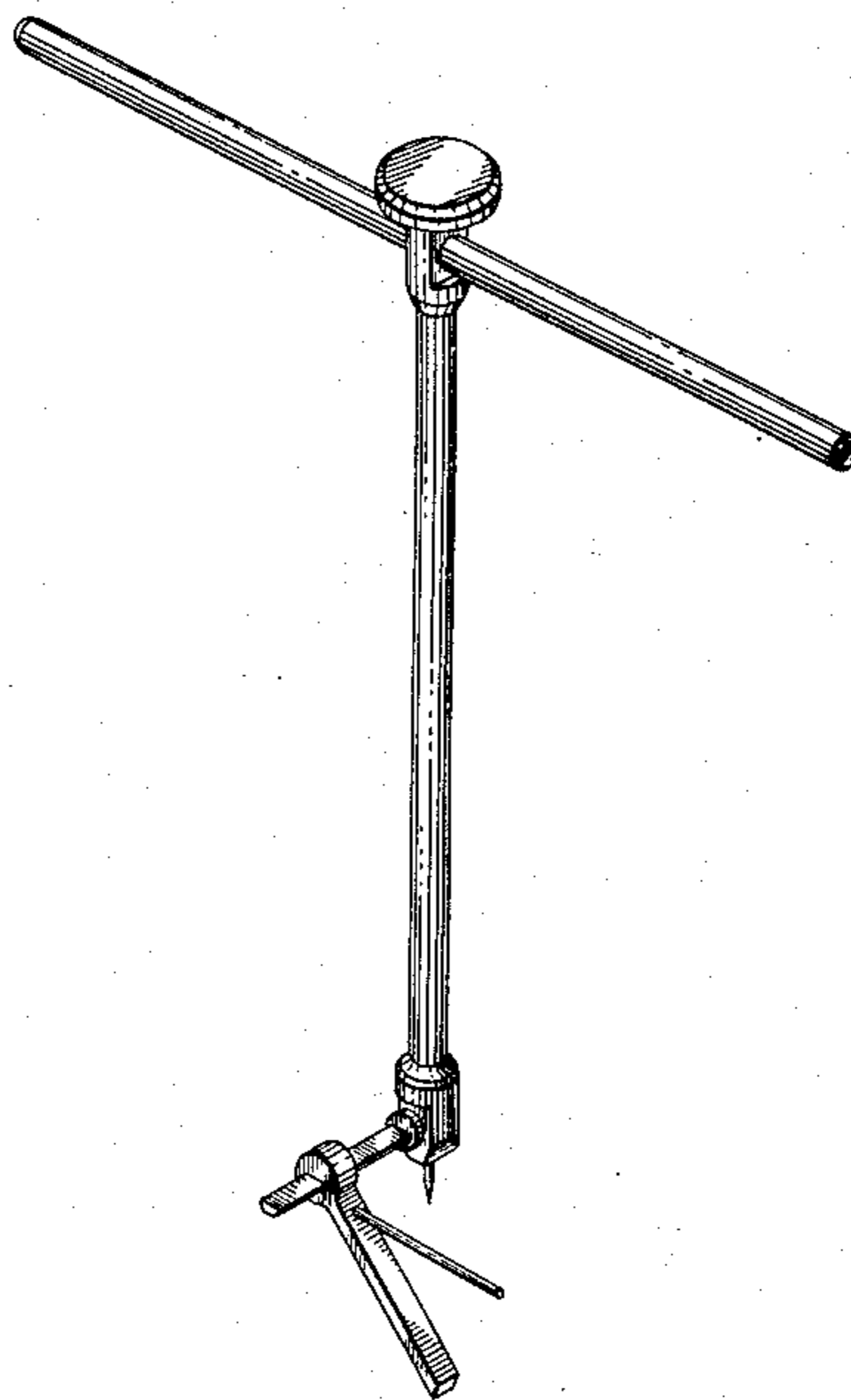
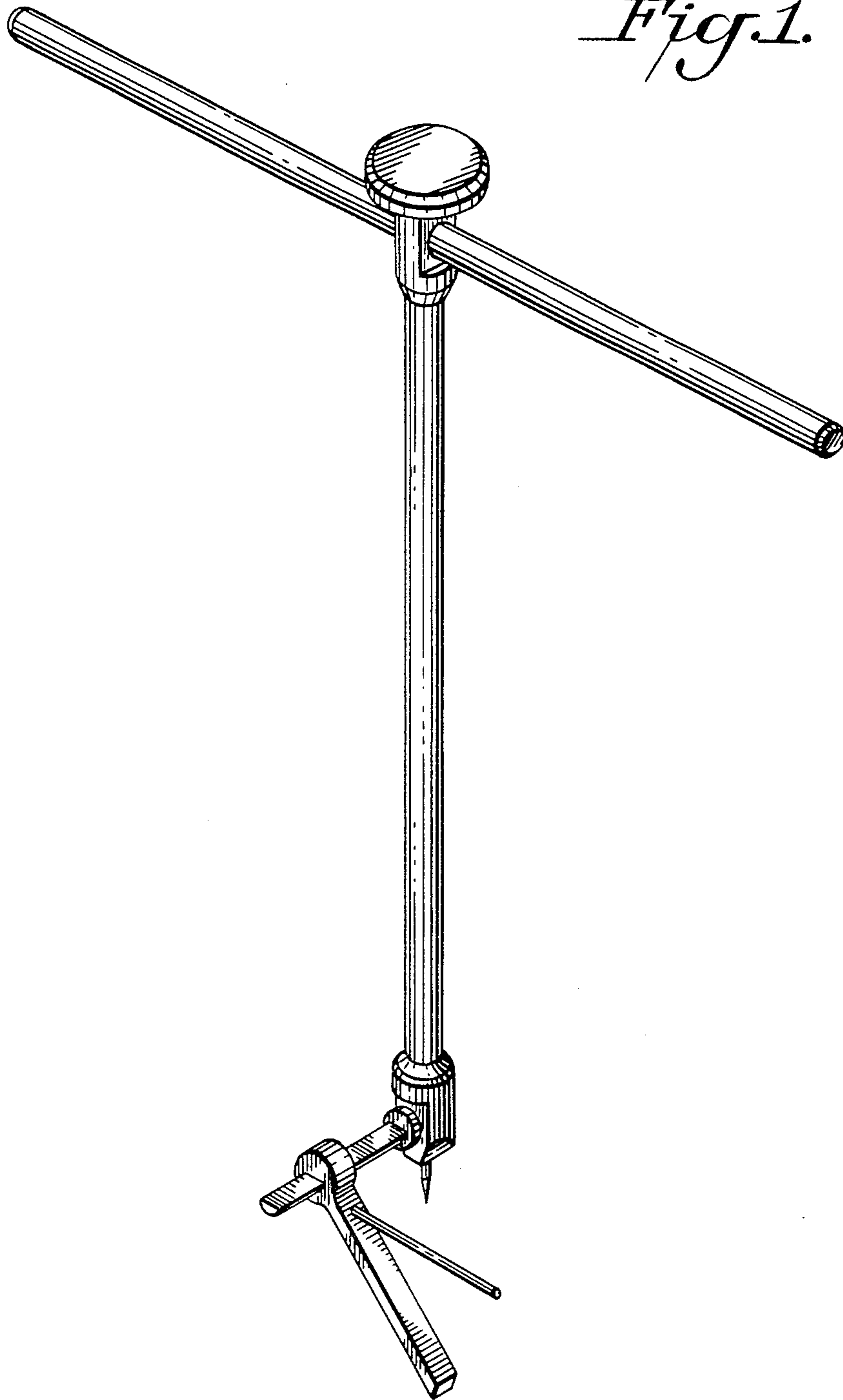

Fig. 1.



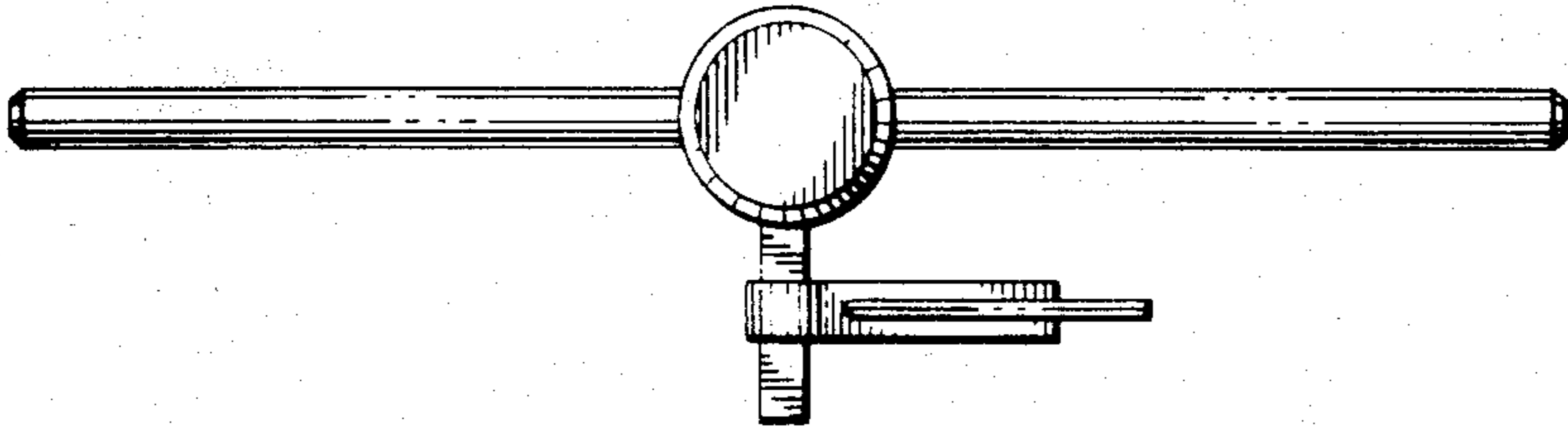

Fig. 4.

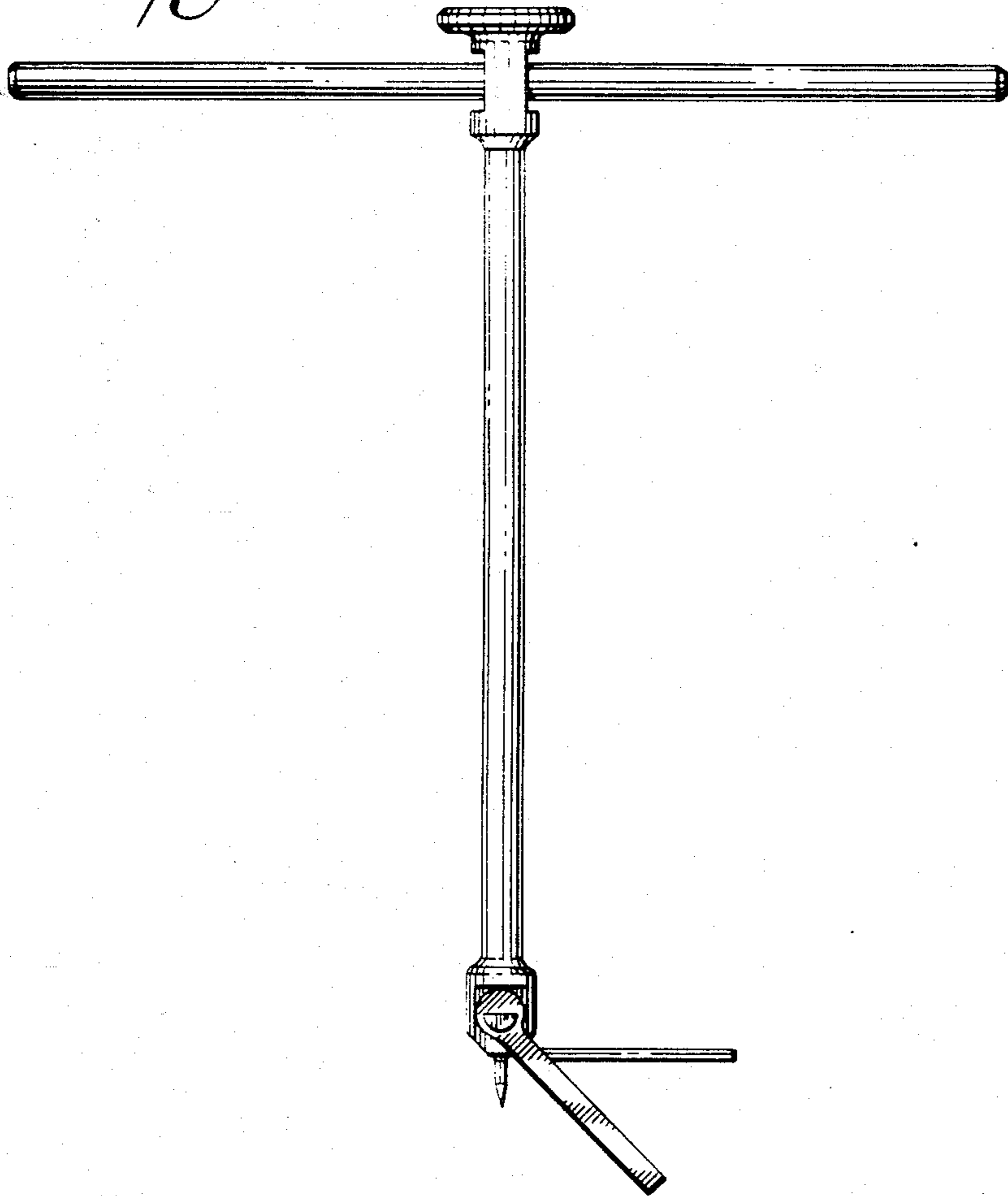

Fig. 2.

Fig. 3.

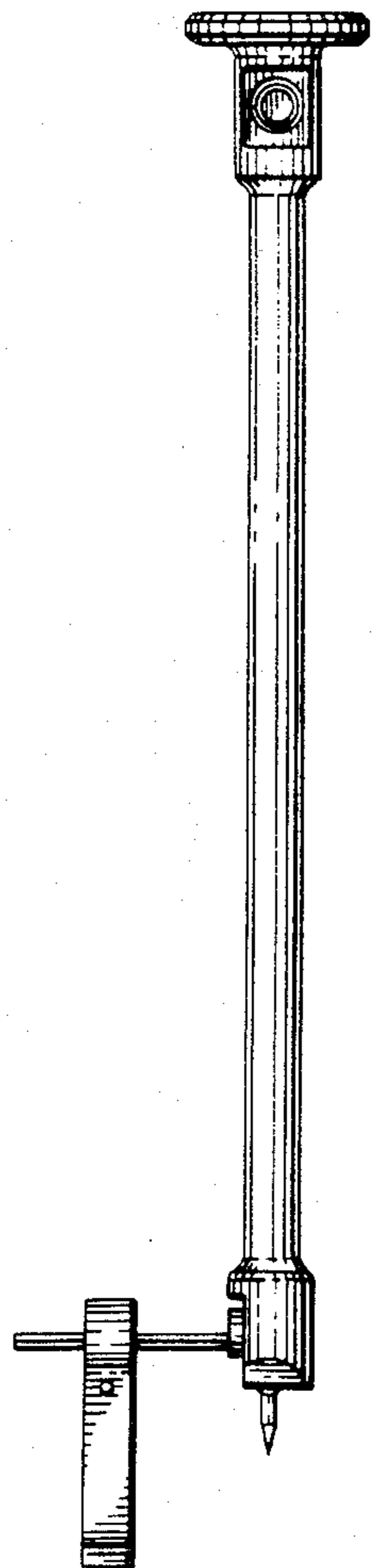

Fig. 5.

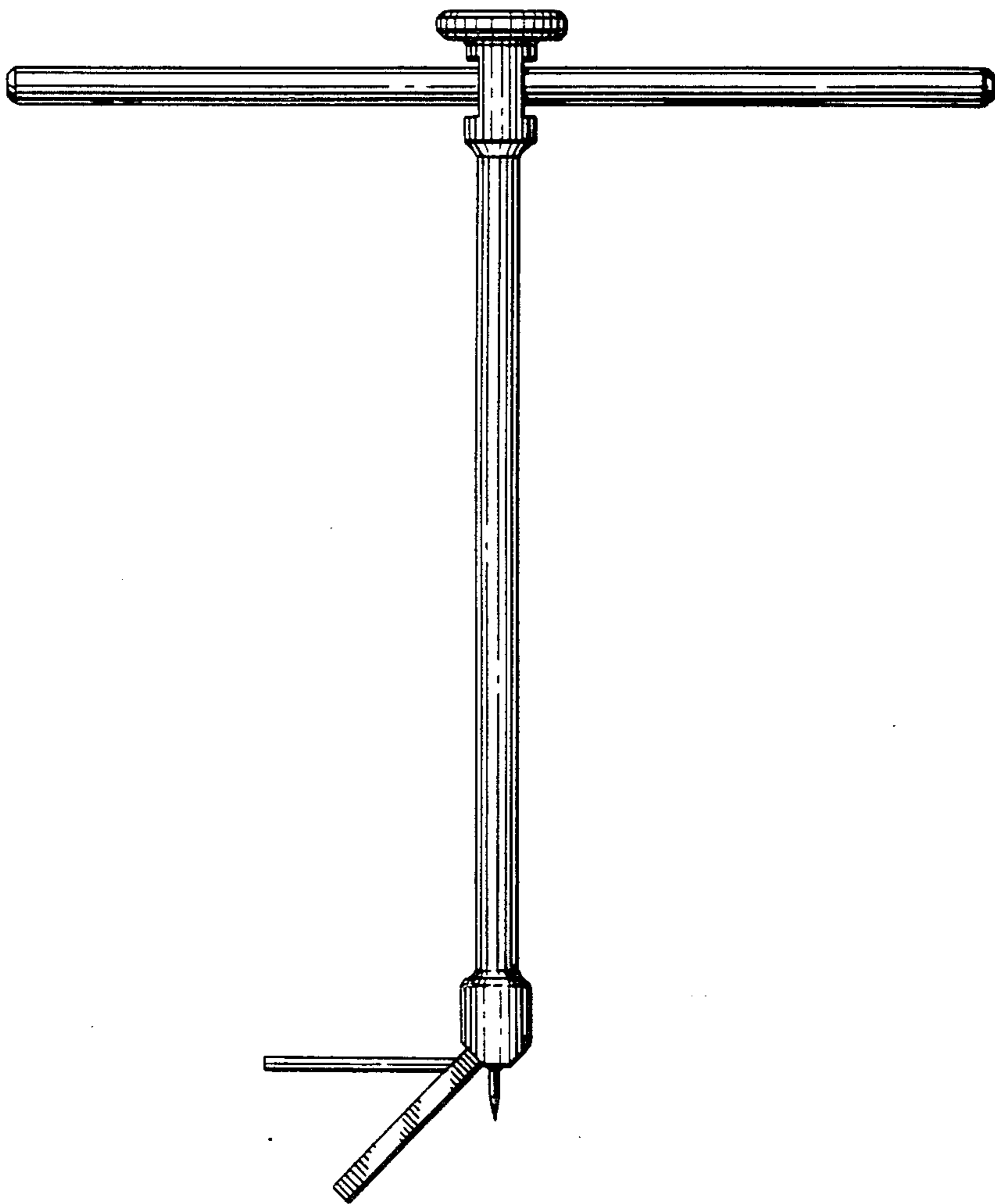

Fig. 6.

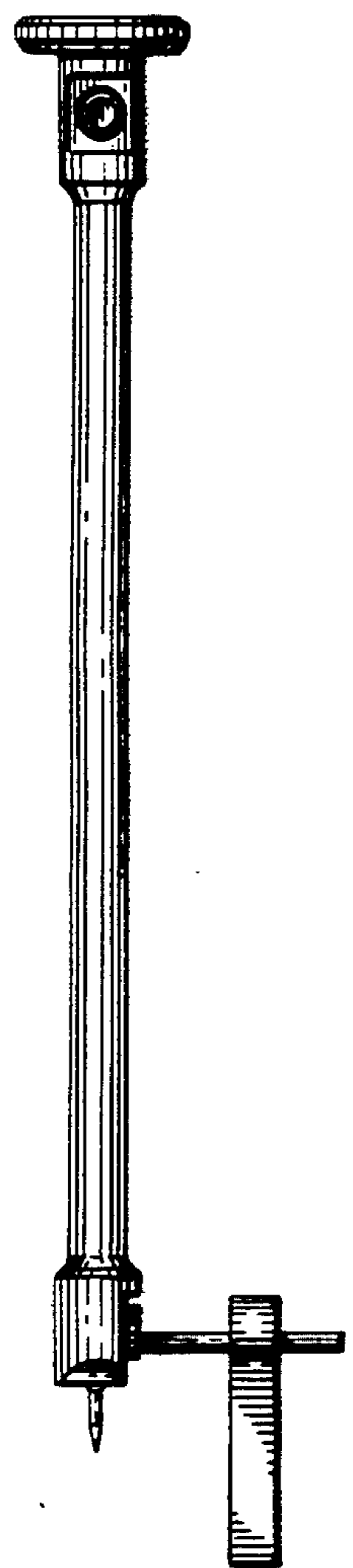

Fig. 7.

