

[54] ACOUSTICALLY COUPLED MODEM

[75] Inventor: Masahiko Mizuno, Shiojiri, Japan

[73] Assignees: Epson Corporation, Nagano; Kabushiki Kaisha Suwa Seikosha, Tokyo, both of Japan

[**] Term: 14 Years

[21] Appl. No.: 524,620

[22] Filed: Aug. 19, 1983

[30] Foreign Application Priority Data

Feb. 24, 1983 [JP] Japan 58-7314

[52] U.S. Cl. D14/57; D14/60; D14/52

[58] Field of Search D14/57, 101, 4, 53, D14/52, 59, 60, 64, 101; 179/100 R, 26, 2 C, 2 DP; 174/50, 52 R

[56] References Cited

U.S. PATENT DOCUMENTS

- D. 212,692 11/1968 Plortholt D14/57
- D. 222,751 12/1971 Rudin D14/57
- D. 224,317 7/1972 Marsalka D14/57
- D. 227,570 7/1973 Kennedy D14/57

- D. 264,337 5/1982 Kessler D14/57
- D. 270,834 10/1983 Genaro et al. D14/57
- D. 279,184 6/1985 Sakamoto D14/57
- 4,068,095 1/1978 Ghormley et al. 179/2 C

OTHER PUBLICATIONS

PortaCom-PC-8110 Comm. Terminal; Integral Phone Coupler, p. 3 and on cover.

Primary Examiner—Wallace R. Burke
Assistant Examiner—Horace B. Foy
Attorney, Agent, or Firm—Blum, Kaplan, Friedman, Silberman & Beran

[57] CLAIM

The ornamental design for an acoustically coupled modem, as shown.

DESCRIPTION

FIG. 1 is a top plan view of an acoustically coupled modem in accordance with my new design; FIG. 2 is a front elevational view thereof; FIG. 3 is a left side view thereof; FIG. 4 is a right side view thereof; FIG. 5 is a rear elevational view thereof; FIG. 6 is a bottom plan view thereof; and FIG. 7 is a perspective view thereof.

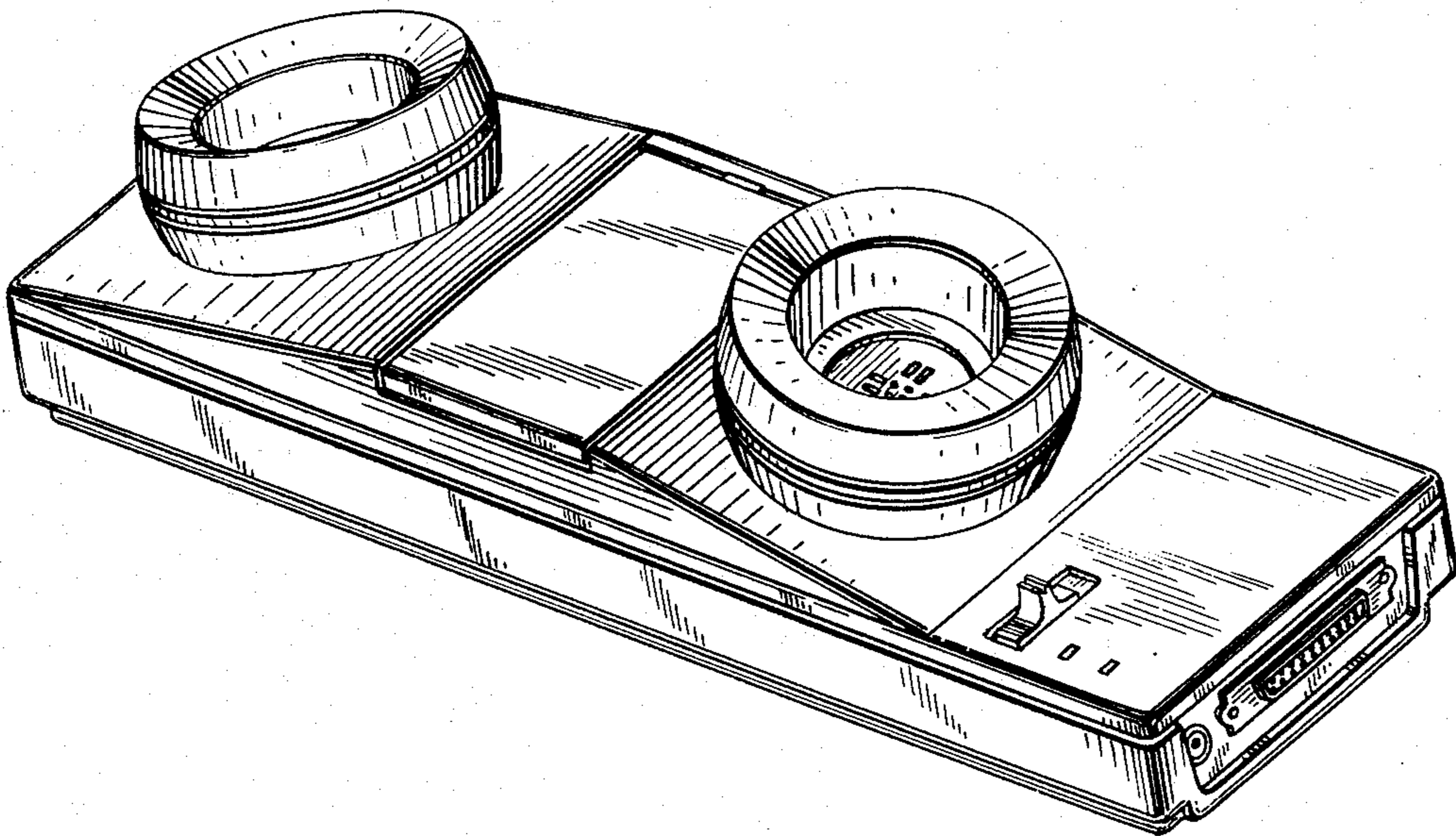
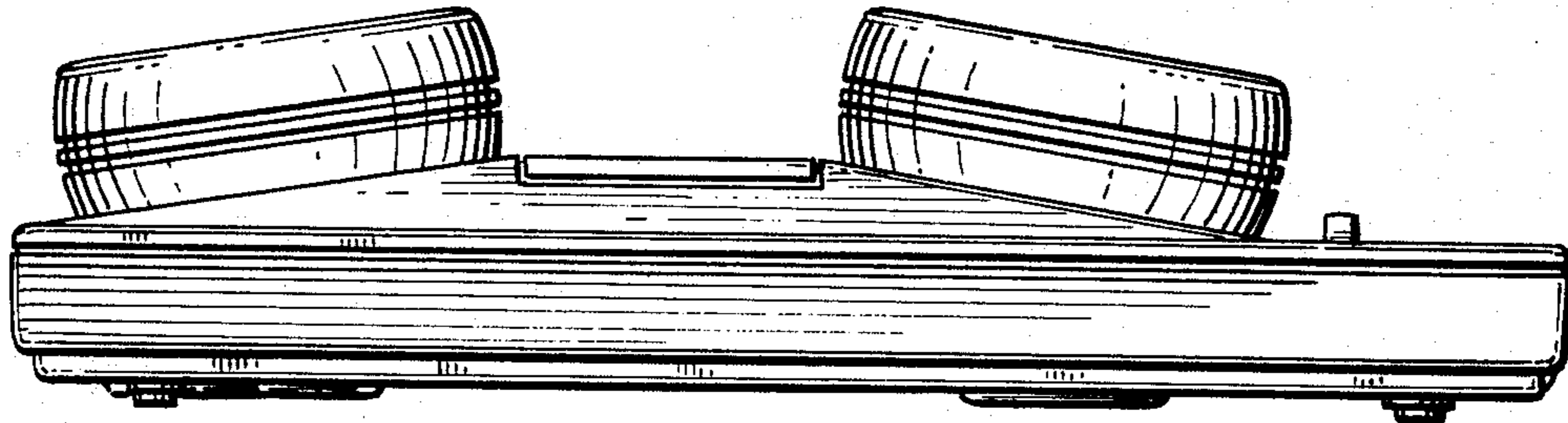

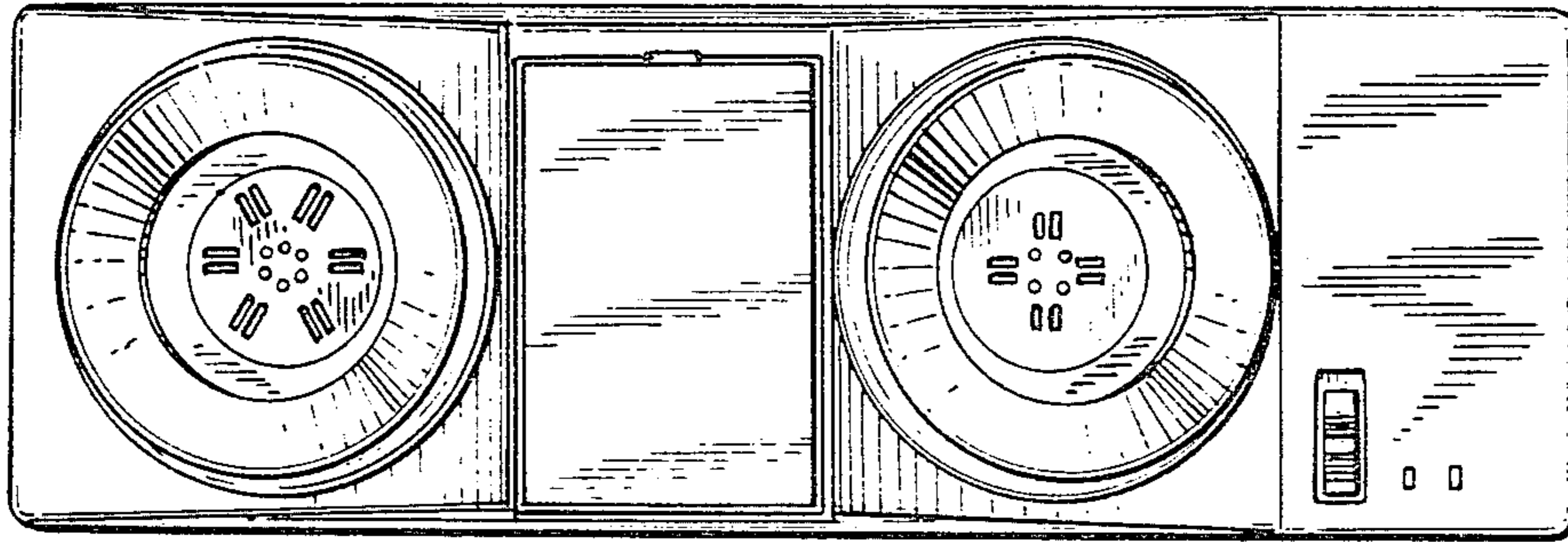

FIG. 1

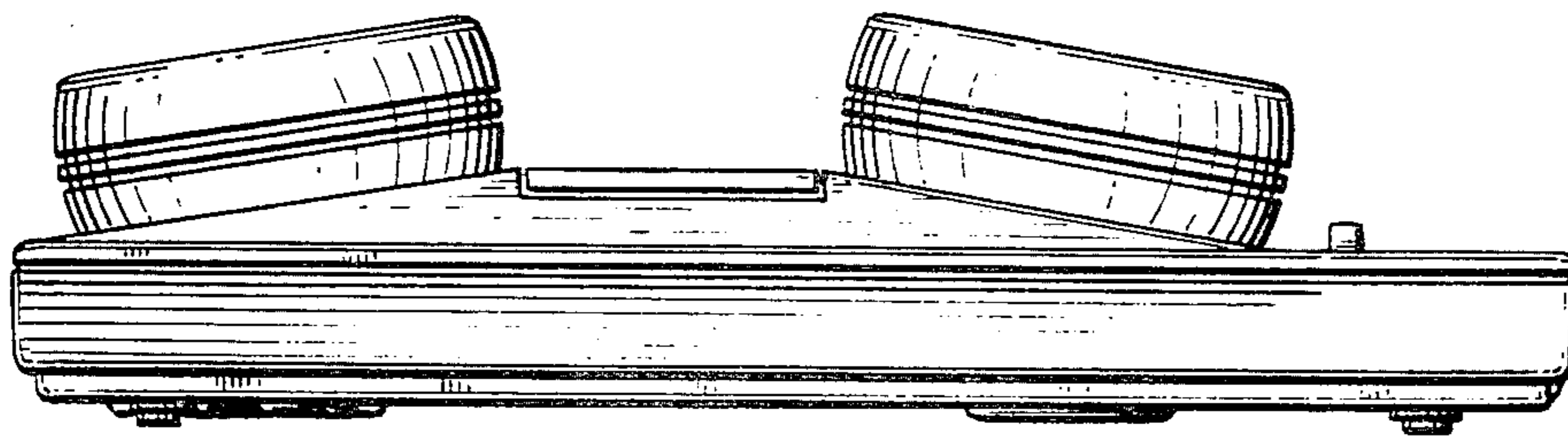

FIG. 2

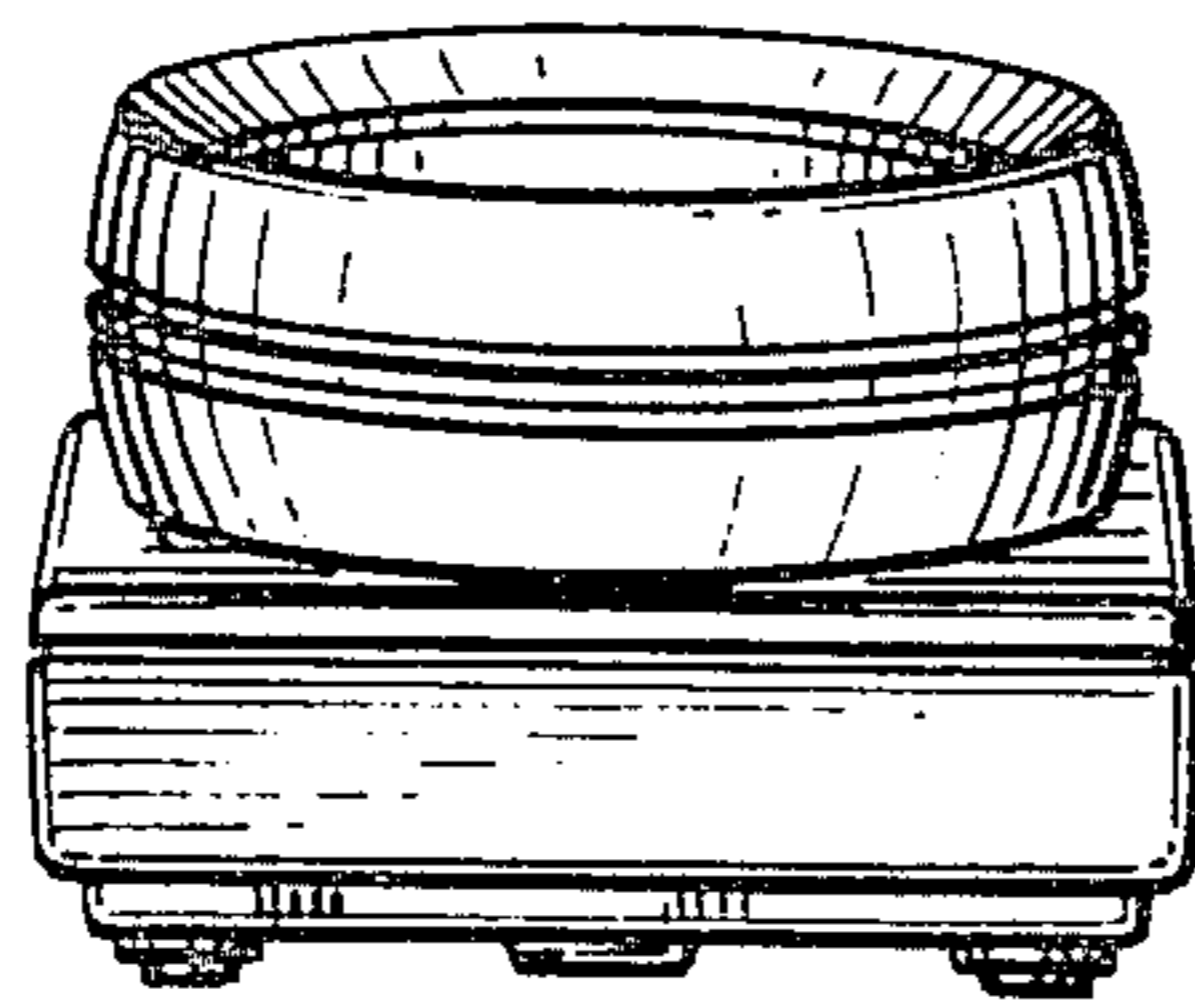

FIG. 3

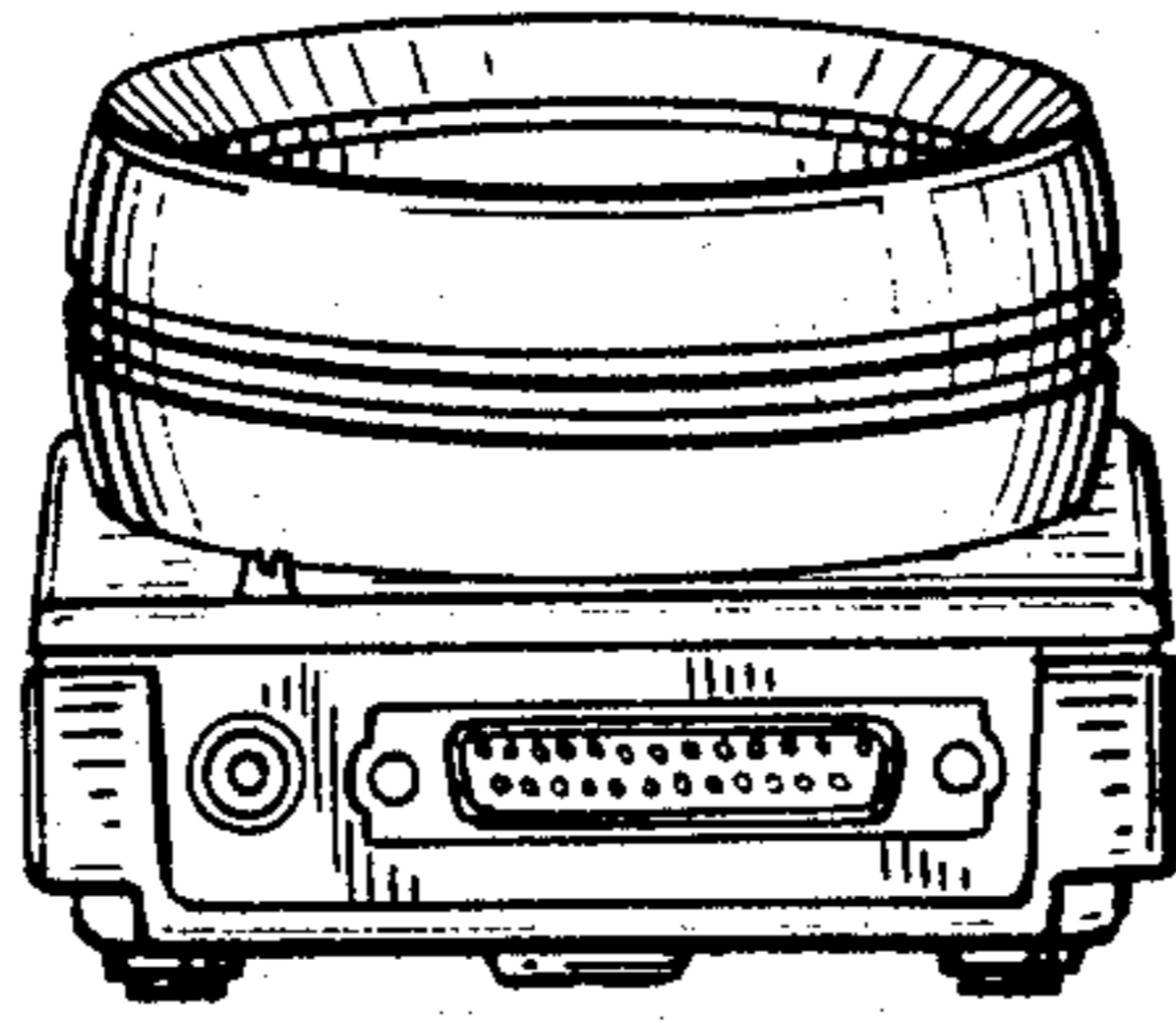

FIG. 4

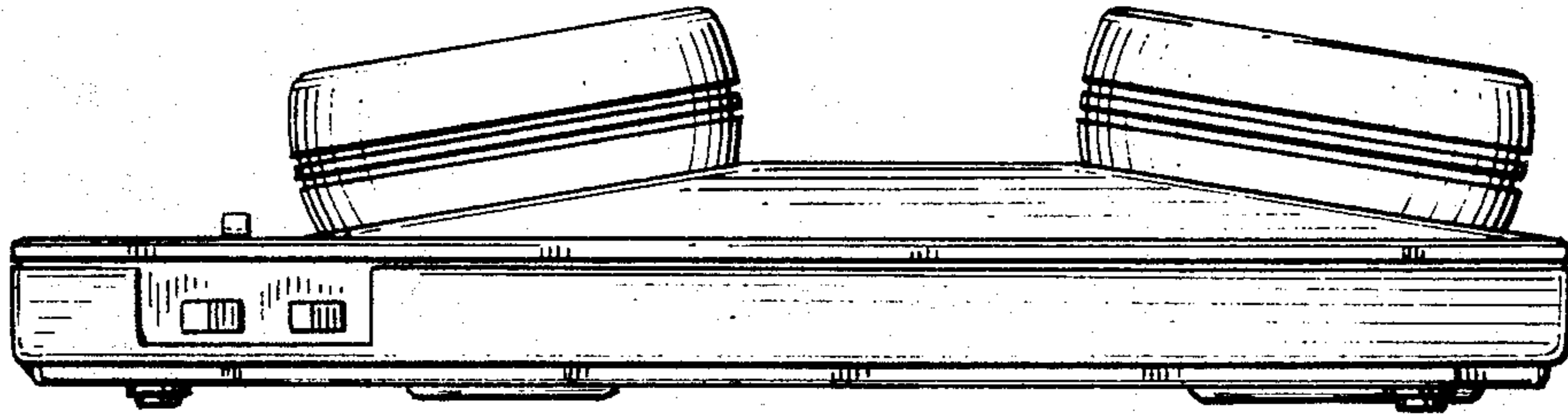

FIG. 5

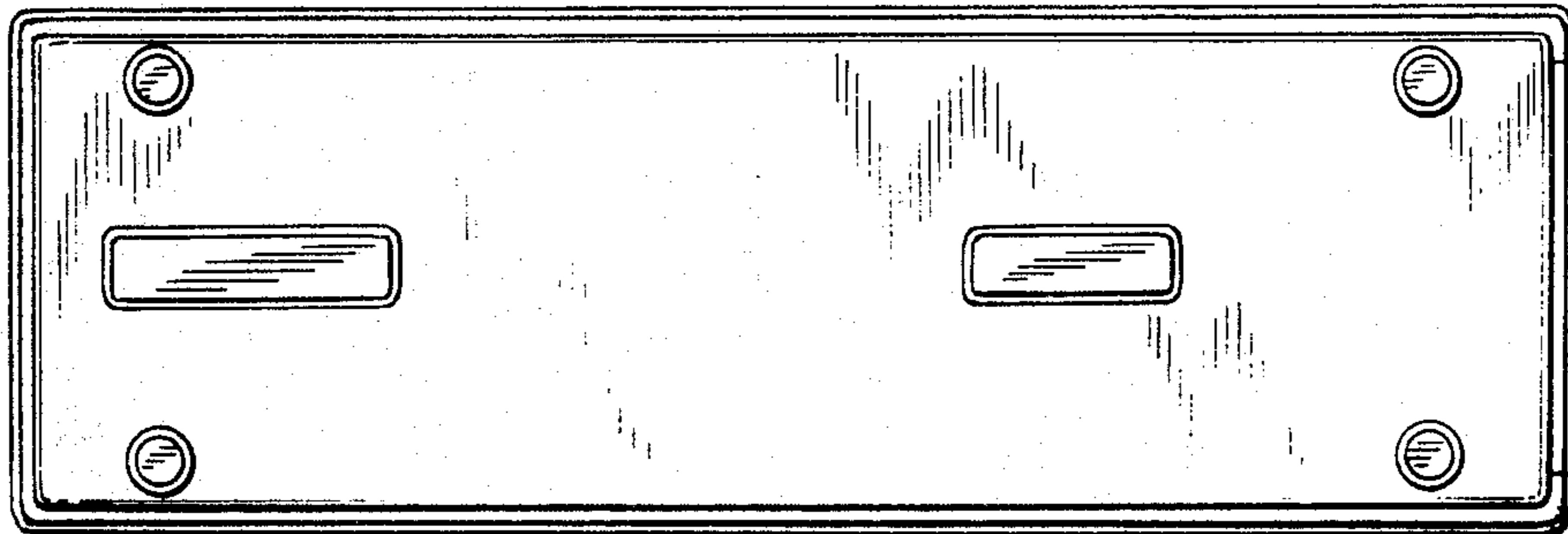

FIG. 6

FIG. 7

