

[54] **ENTERTAINMENT CENTER**  
[76] **Inventor: Vincent A. Branciforti, 2312 Artic Ave., Atlantic City, N.J. 08401**  
[\*\*] **Term: 14 Years**  
[21] **Appl. No.: 521,888**  
[22] **Filed: Aug. 10, 1983**  
[52] **U.S. Cl. .... D6/474; D6/571**  
[58] **Field of Search ..... D6/442, 449, 474, 477, D6/478, 479, 553, 556, 558, 567, 569, 570, 574, 571; 108/59, 92, 93, 111**

[56] **References Cited**  
**U.S. PATENT DOCUMENTS**  
D. 161,627 1/1951 Haworth ..... D6/571  
D. 174,377 4/1955 Dossman ..... D6/571  
D. 211,647 7/1968 Hardin ..... D6/571

**OTHER PUBLICATIONS**  
"Metal Display Fixtures" by L. A. Darling & Co. Cat.

#140, p. 6; Window Display Fixtures #2017, center right of page.  
"Furniture of Romance" by Ficks Reed Co., p. 11 Wall Rack #8331 top left on page.

*Primary Examiner*—Carmen H. Vales  
*Attorney, Agent, or Firm*—Thomas A. Lennox

[57] **CLAIM**  
The ornamental design for an entertainment center, as shown.

**DESCRIPTION**  
FIG. 1 is a perspective view of an entertainment center showing my new design;  
FIG. 2 is a front elevational view thereof;  
FIG. 3 is a bottom plan view thereof;  
FIG. 4 is a left side elevational view thereof;  
FIG. 5 is a rear elevational view thereof;  
FIG. 6 is a right side elevational view thereof;  
FIG. 7 is a top plan view thereof.

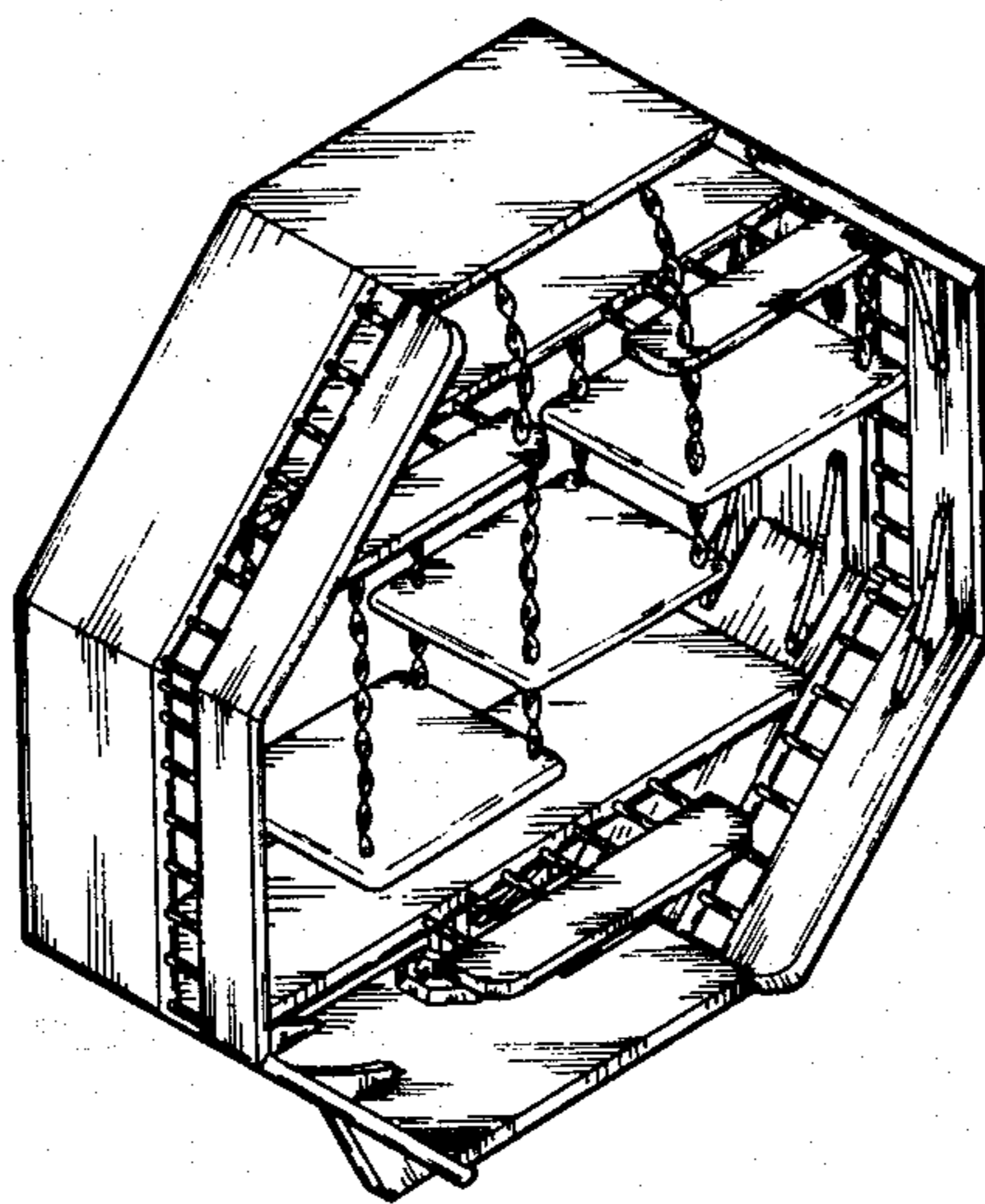

*Fig. 1*

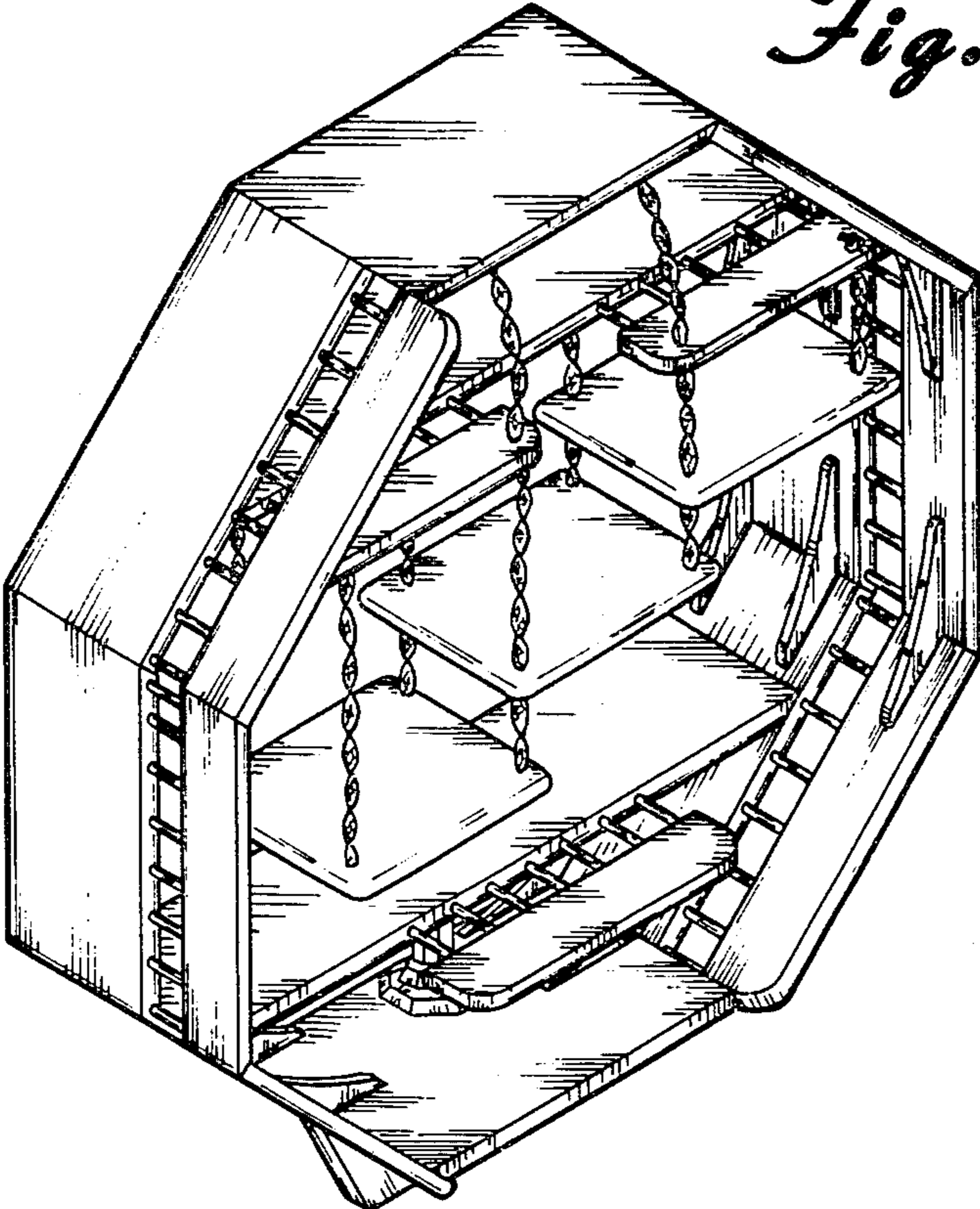

*Fig. 2*

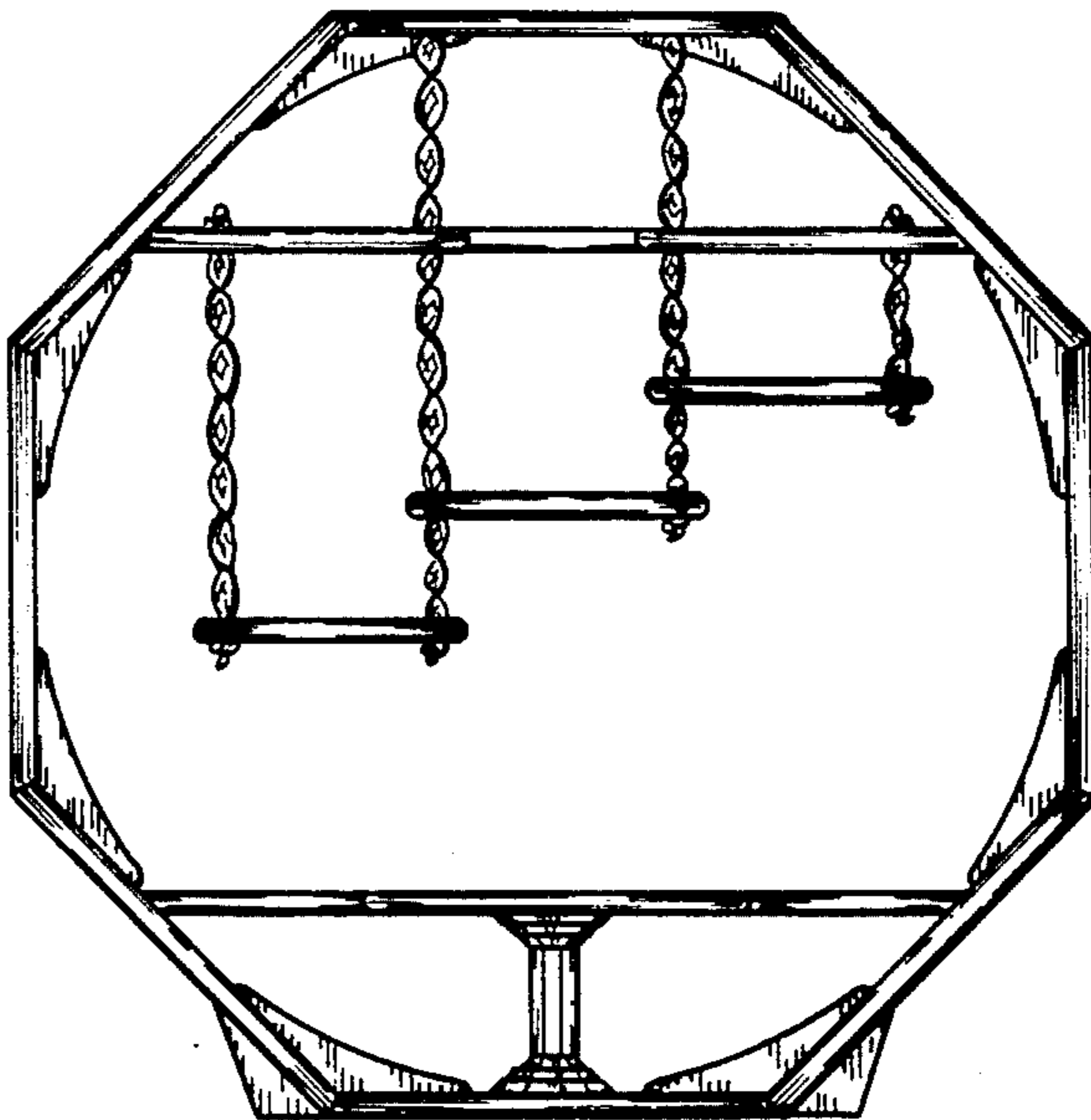

*Fig. 3*

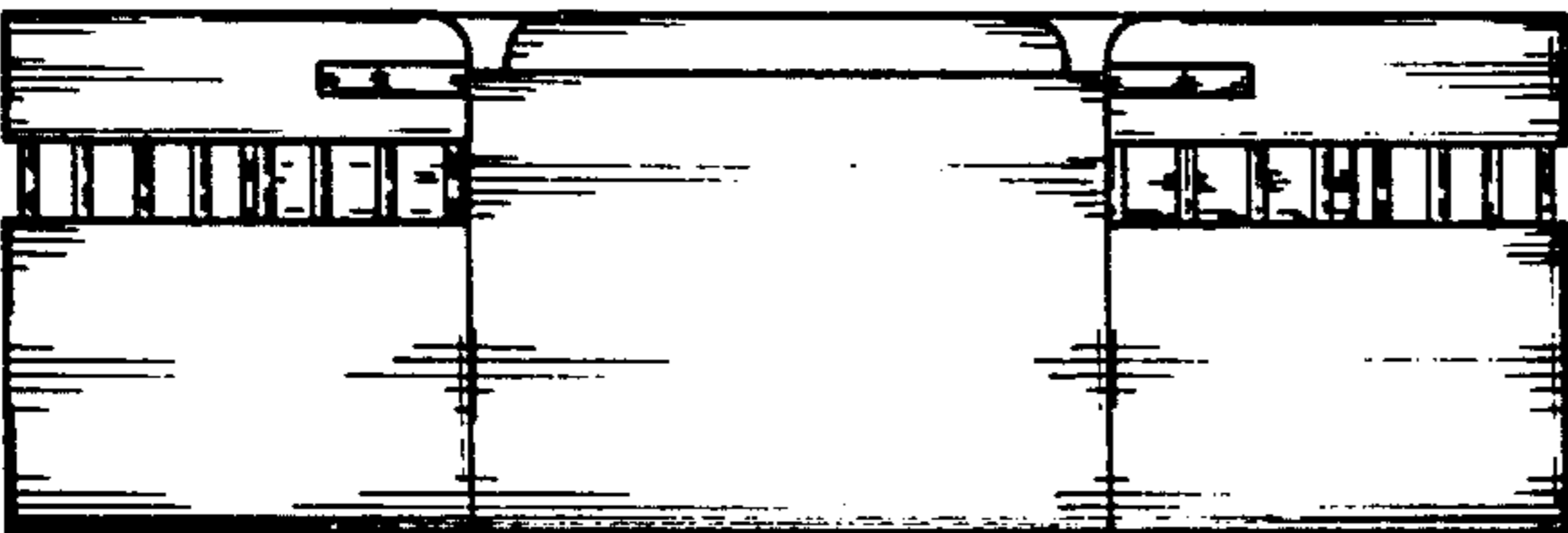

*Fig. 4*

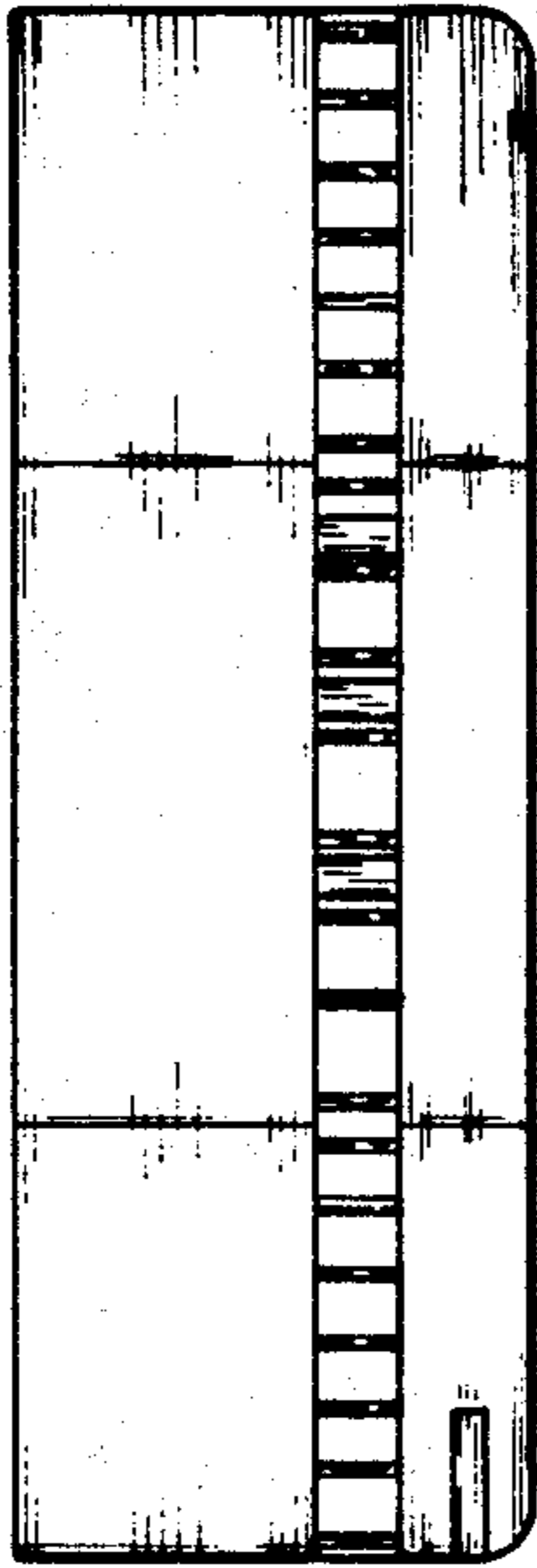

*Fig. 5*

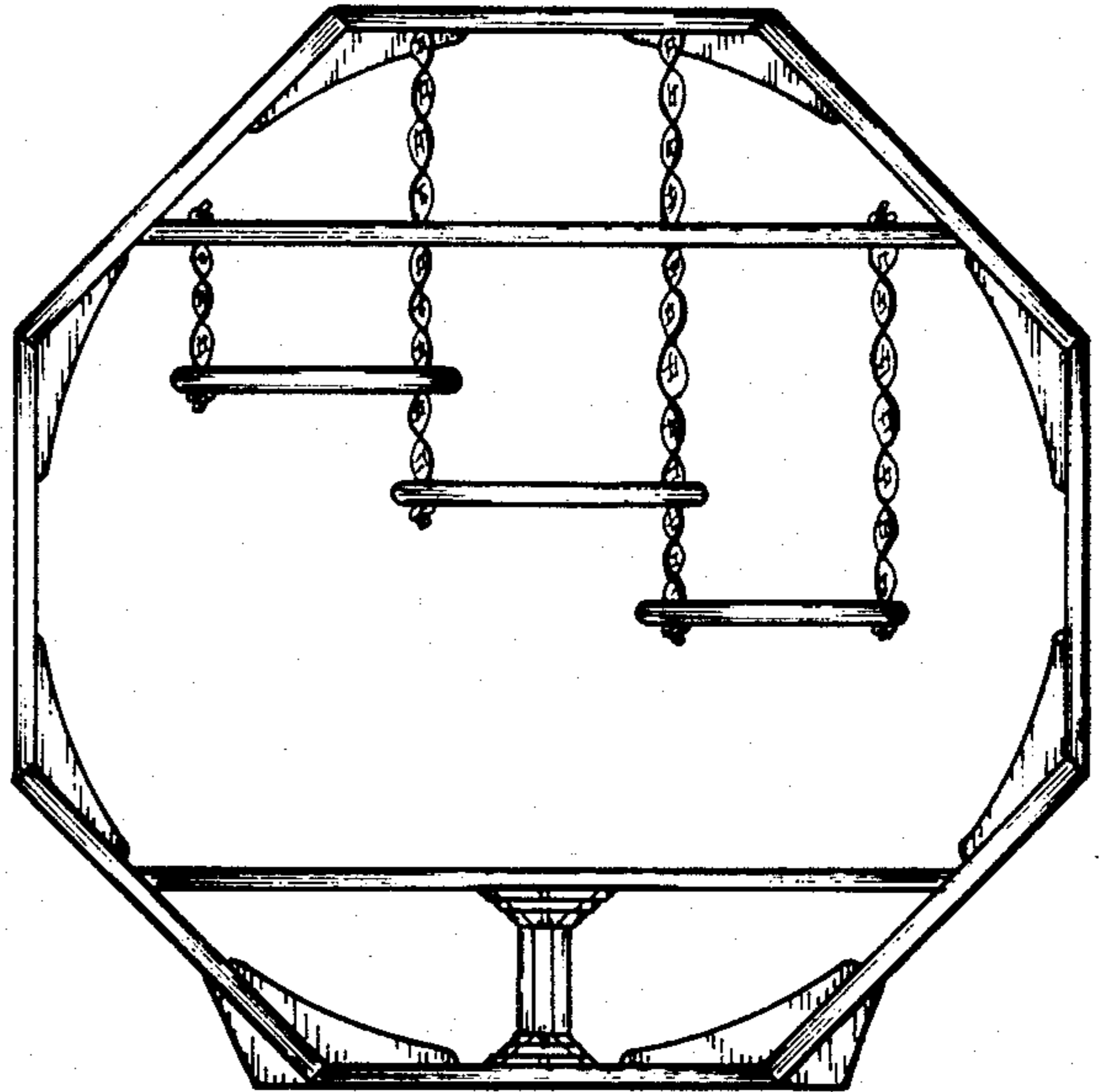

*Fig. 6*

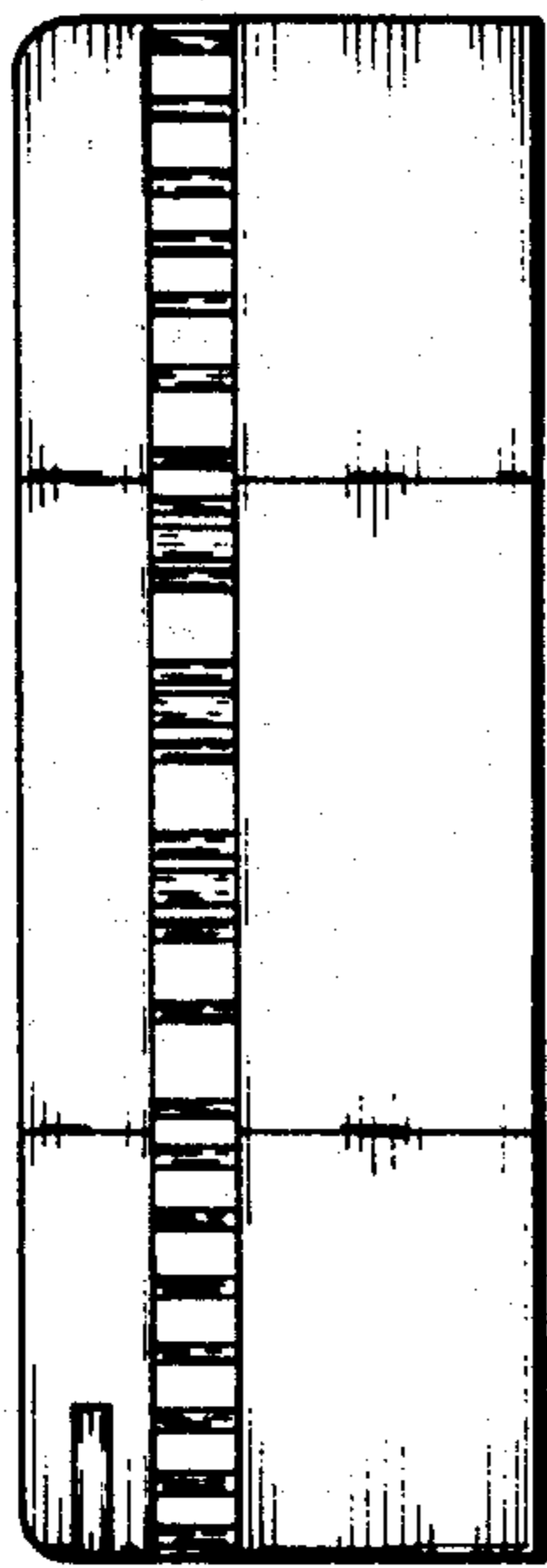

*Fig. 7*

