

[54] **DATA TRANSMITTING OPTICAL COUPLER**

[75] **Inventors: Nobuo Kikuchi, Tokyo; Hideo Fushimoto, Kawasaki, both of Japan**

[73] **Assignee: Canon Kabushiki Kaisha, Tokyo, Japan**

[\*\*] **Term: 14 Years**

[21] **Appl. No.: 486,224**

[22] **Filed: Apr. 18, 1983**

[30] **Foreign Application Priority Data**

Oct. 20, 1982 [JP] Japan ..... 57-47795  
[52] **U.S. Cl.** ..... **D14/114**  
[58] **Field of Search** ..... D14/100-109,  
D14/113-116; 350/96.15, 96.16; 455/600, 606,  
610, 612, 617

[56]

**References Cited**

**U.S. PATENT DOCUMENTS**

2,494,645 1/1950 Collins ..... 455/606  
4,249,265 2/1981 Coester ..... 455/606 X

*Primary Examiner*—Susan J. Lucas  
*Attorney, Agent, or Firm*—Fitzpatrick, Cella, Harper & Scinto

[57]

**CLAIM**

The ornamental design for a data transmitting optical coupler, as shown and described.

**DESCRIPTION**

FIG. 1 is a front elevational view of a data transmitting optical coupler showing our new design;  
FIG. 2 is a rear elevational view thereof;  
FIG. 3 is a top plan view thereof;  
FIG. 4 is a bottom plan view thereof;  
FIG. 5 is a side elevational view thereof as seen from the left of FIG. 1;  
FIG. 6 is a side elevational view thereof as seen from the right of FIG. 1;  
FIG. 7 is a perspective view thereof.

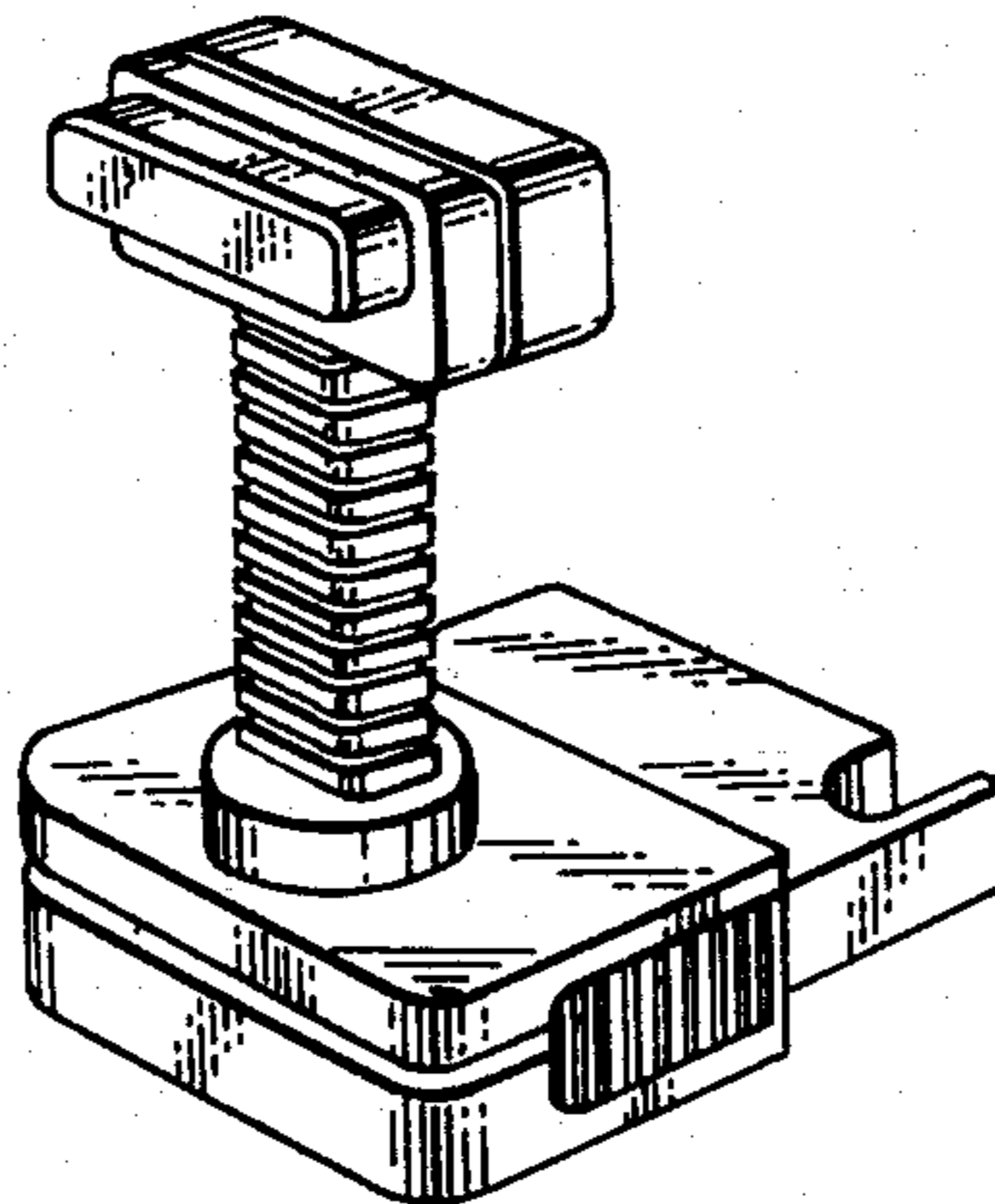

FIG. 1

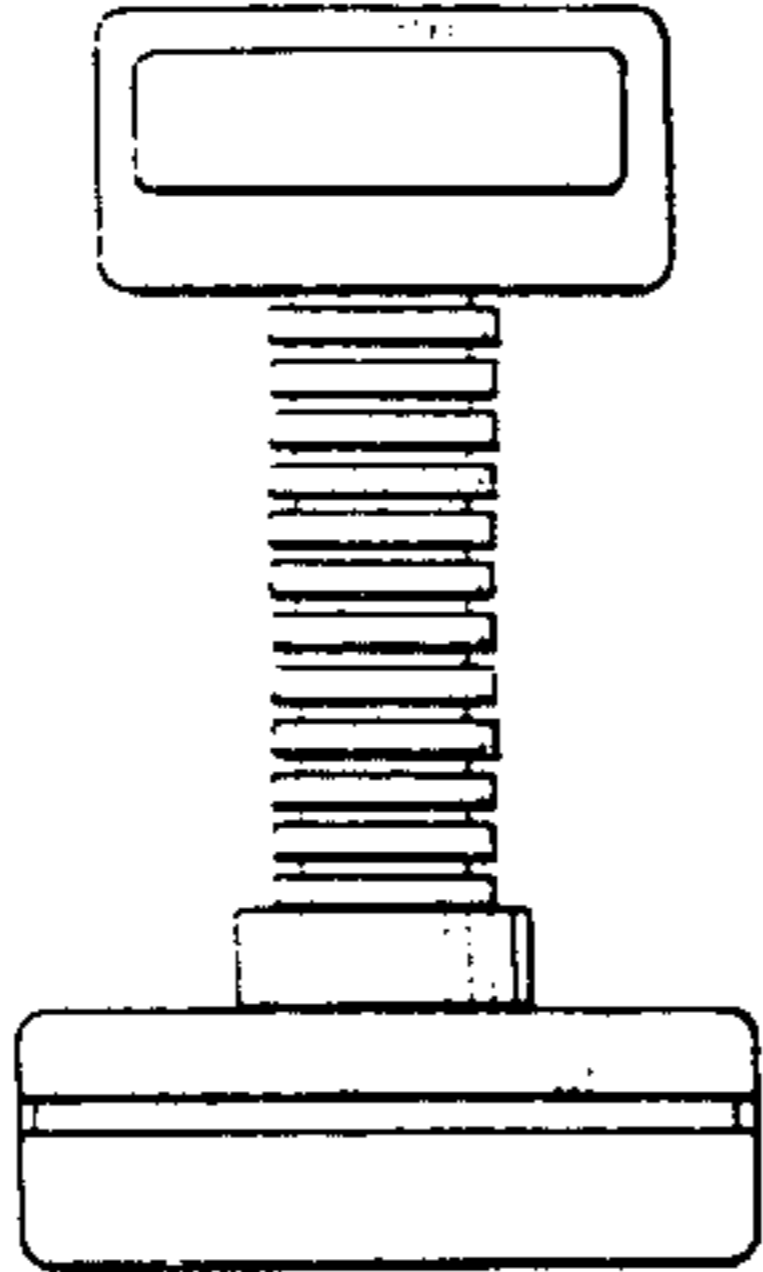

FIG. 2

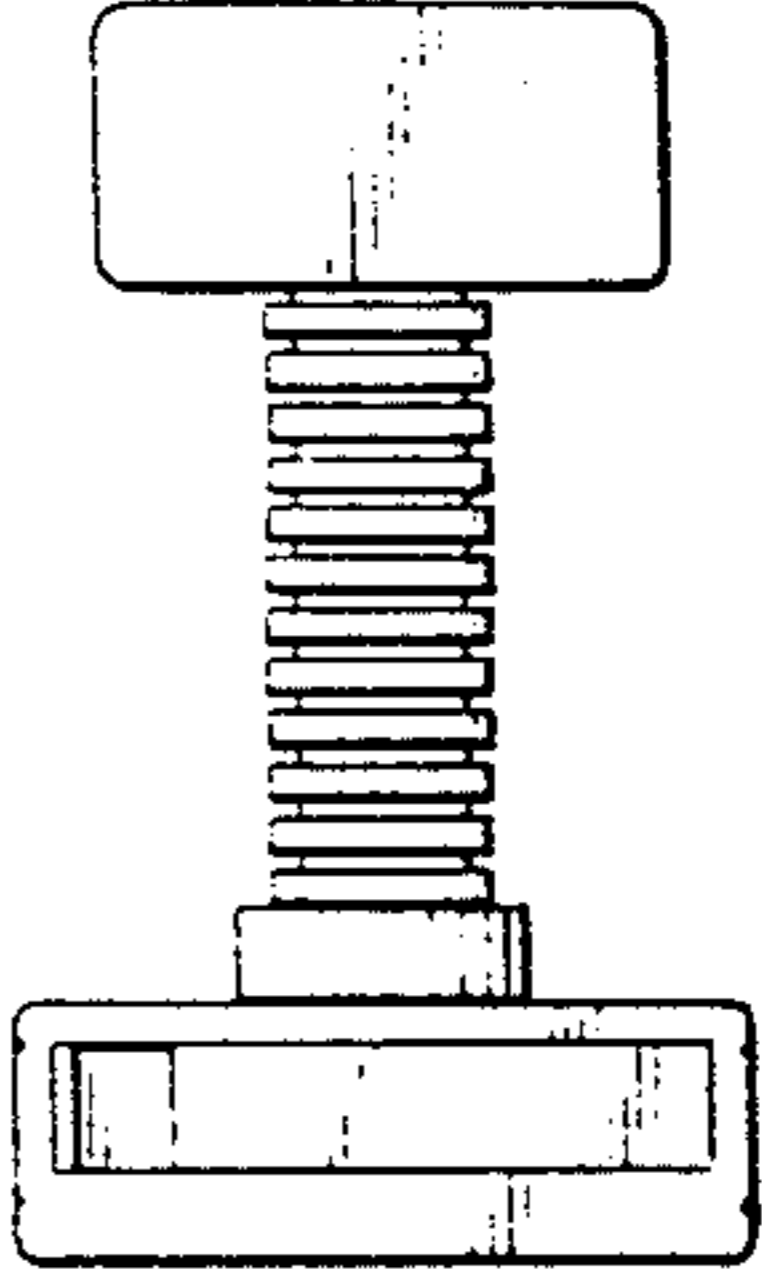

FIG. 3

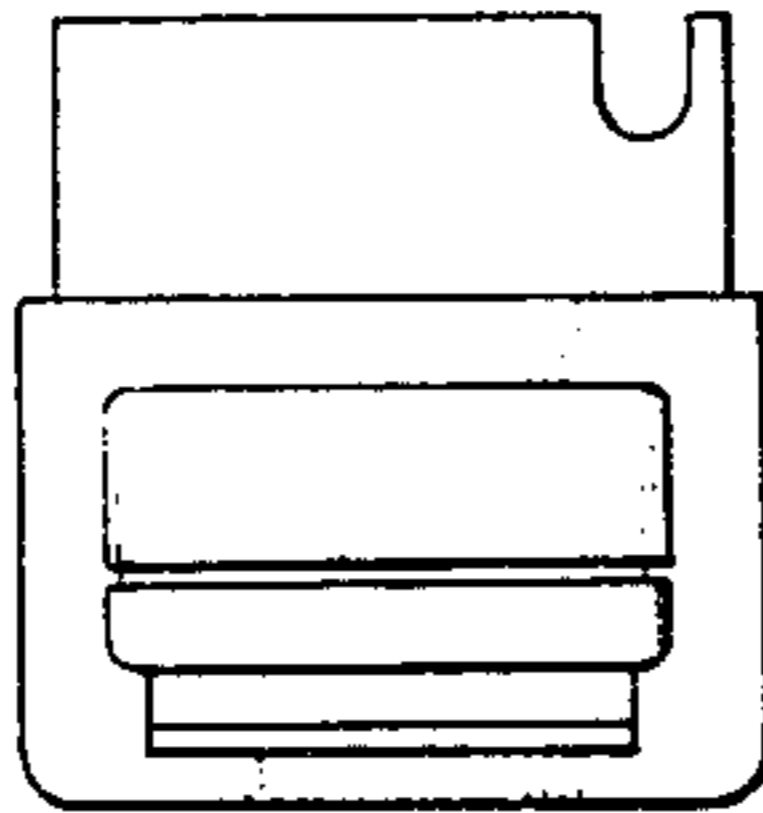

FIG. 4

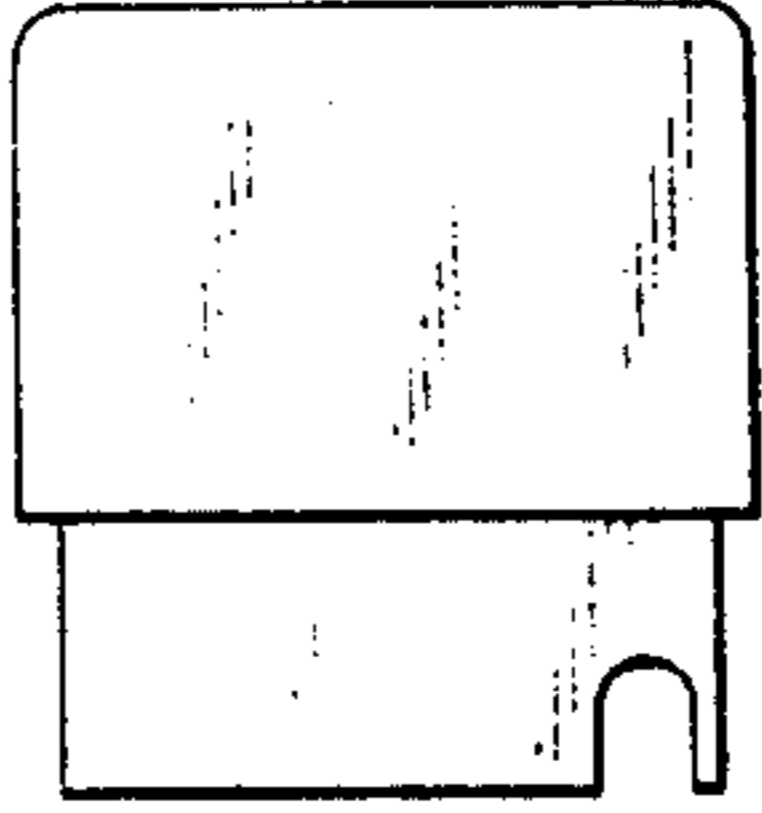

FIG. 5

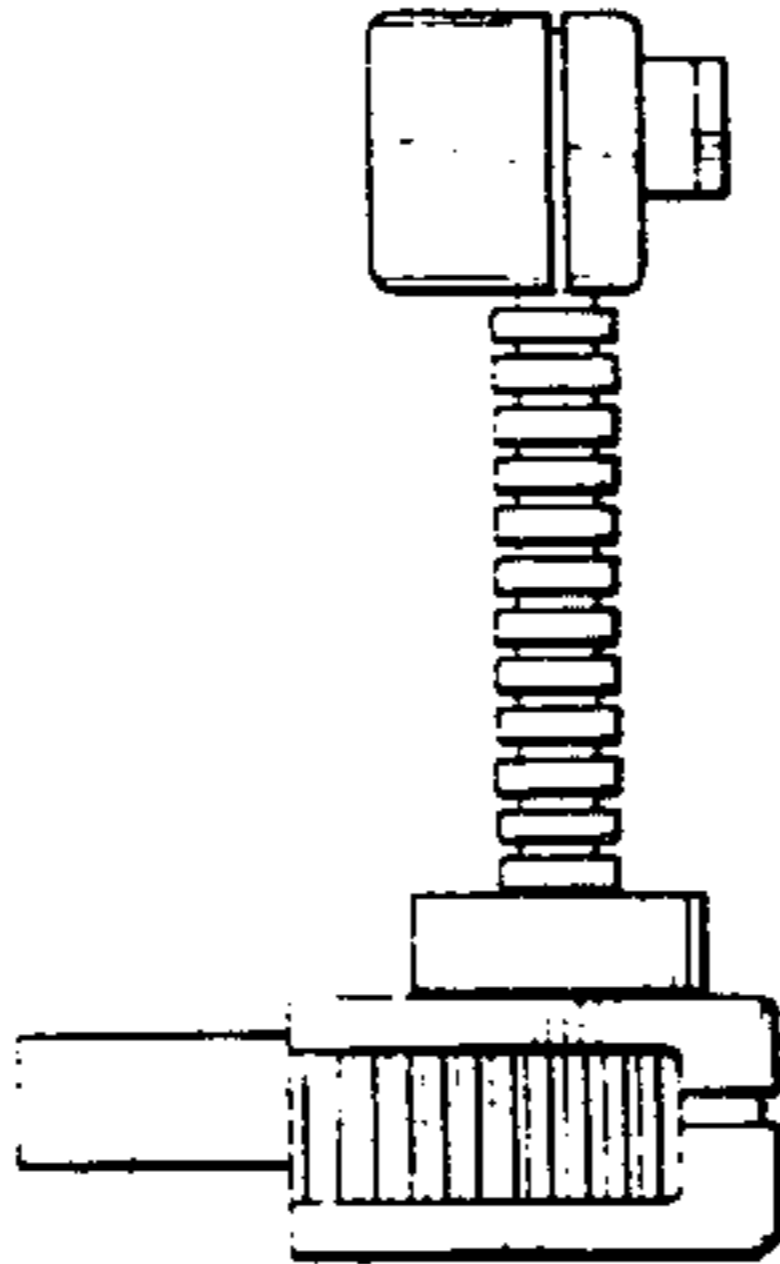

FIG. 6

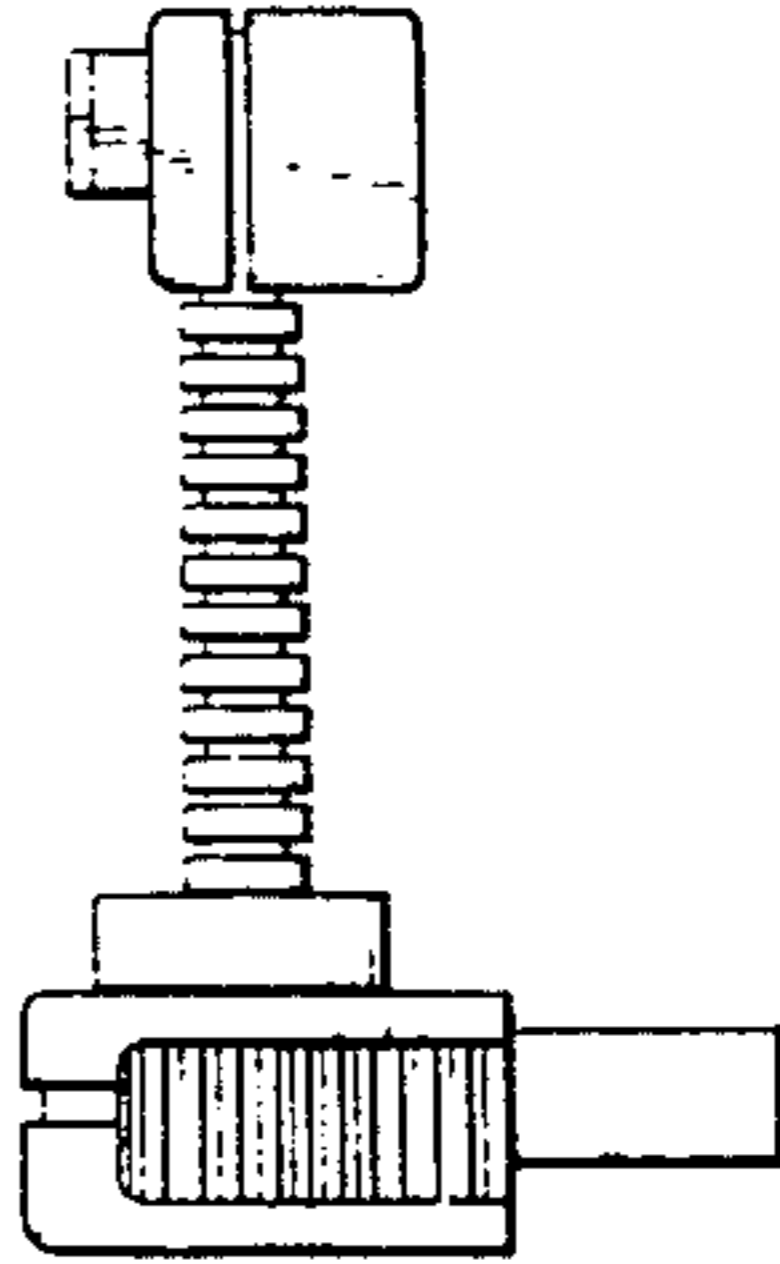

FIG. 7

