

[54] **TUMBLER OR SIMILAR ARTICLE**

[76] **Inventor: Jean-Jacques Durand, LaBute, 62510 Arques, France**

[**] **Term: 14 Years**

[21] **Appl. No.: 523,579**

[22] **Filed: Aug. 16, 1983**

[52] **U.S. Cl. D7/15**

[58] **Field of Search D7/3, 7, 6, 11, 12, D7/13, 14, 15; D9/349**

[56] **References Cited**

U.S. PATENT DOCUMENTS

- D. 4,225 7/1870 Atterbury et al. D9/349
- D. 105,943 9/1937 Fuerst D7/15
- D. 211,152 5/1968 Fuerst D9/349
- D. 272,213 1/1984 Daenen D7/6

FOREIGN PATENT DOCUMENTS

- 134201 7/1933 Austria D7/6 X

Primary Examiner—Winifred E. Herrmann
Attorney, Agent, or Firm—Kimmel, Crowell & Weaver

[57] **CLAIM**

The ornamental design for a tumbler or similar article, substantially as shown and described.

DESCRIPTION

FIG. 1 is a side elevational view of a tumbler or similar article showing my new design in the size and proportions of a water glass, the other side being a mirror image thereof;

FIG. 2 is a sectional view thereof taken along the lines 2—2 of FIG. 3;

FIG. 3 is a top plan view thereof;

FIG. 4 is a bottom plan view thereof;

FIG. 5 is a side elevational view of a tumbler or similar article showing my new design in the size and proportions of an on-the-rocks glass, the other side being a mirror image thereof;

FIG. 6 is a sectional view thereof taken along the lines 6—6 of FIG. 7;

FIG. 7 is a top plan view thereof;

FIG. 8 is a bottom plan view thereof;

FIG. 9 is a side elevational view of a tumbler or similar article showing my new design in the size and proportions of a juice glass, the other side being a mirror image thereof;

FIG. 10 is a sectional view thereof taken along the lines 10—10 of FIG. 11;

FIG. 11 is a top plan view thereof; and

FIG. 12 is a bottom plan view thereof.

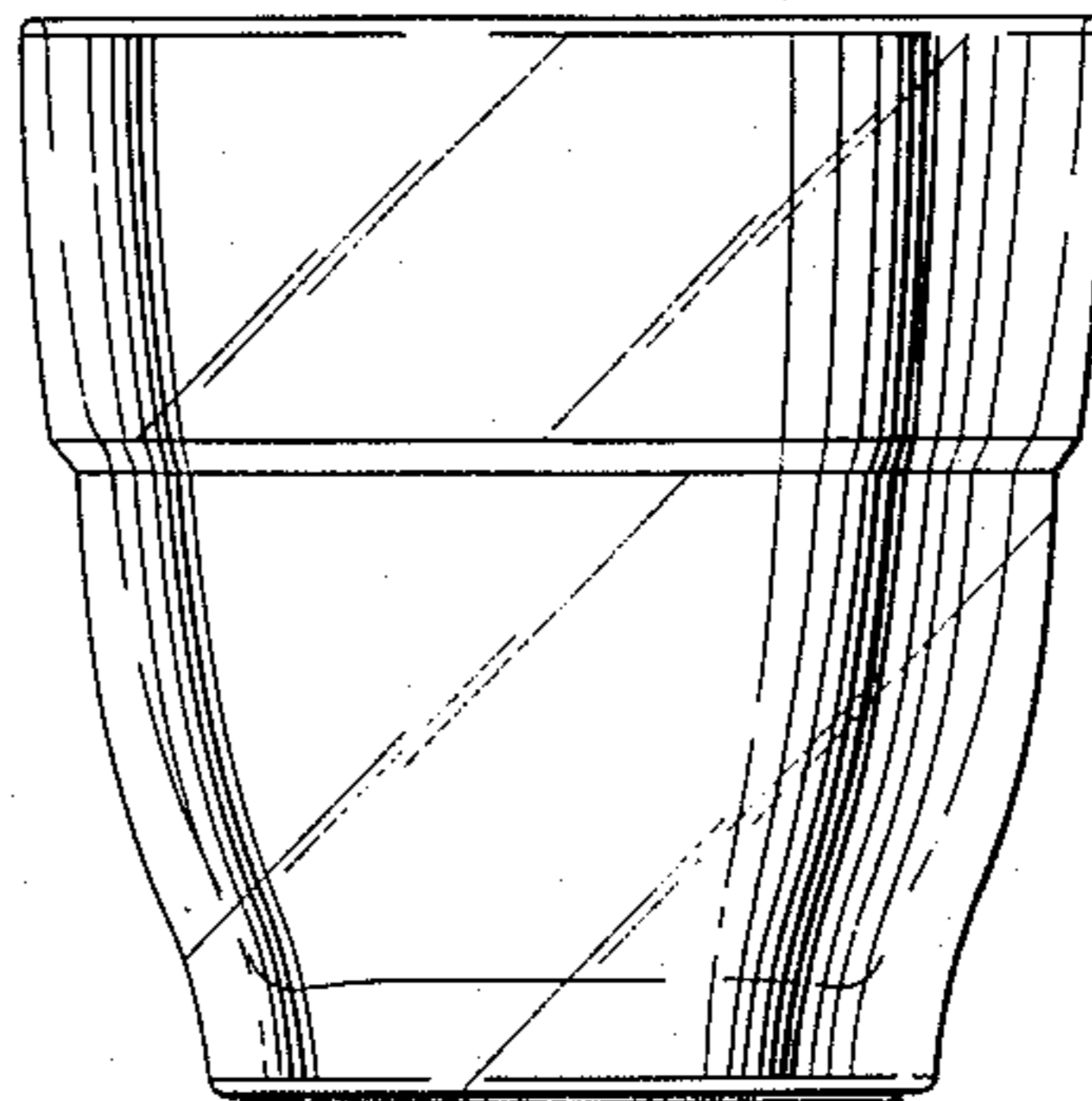
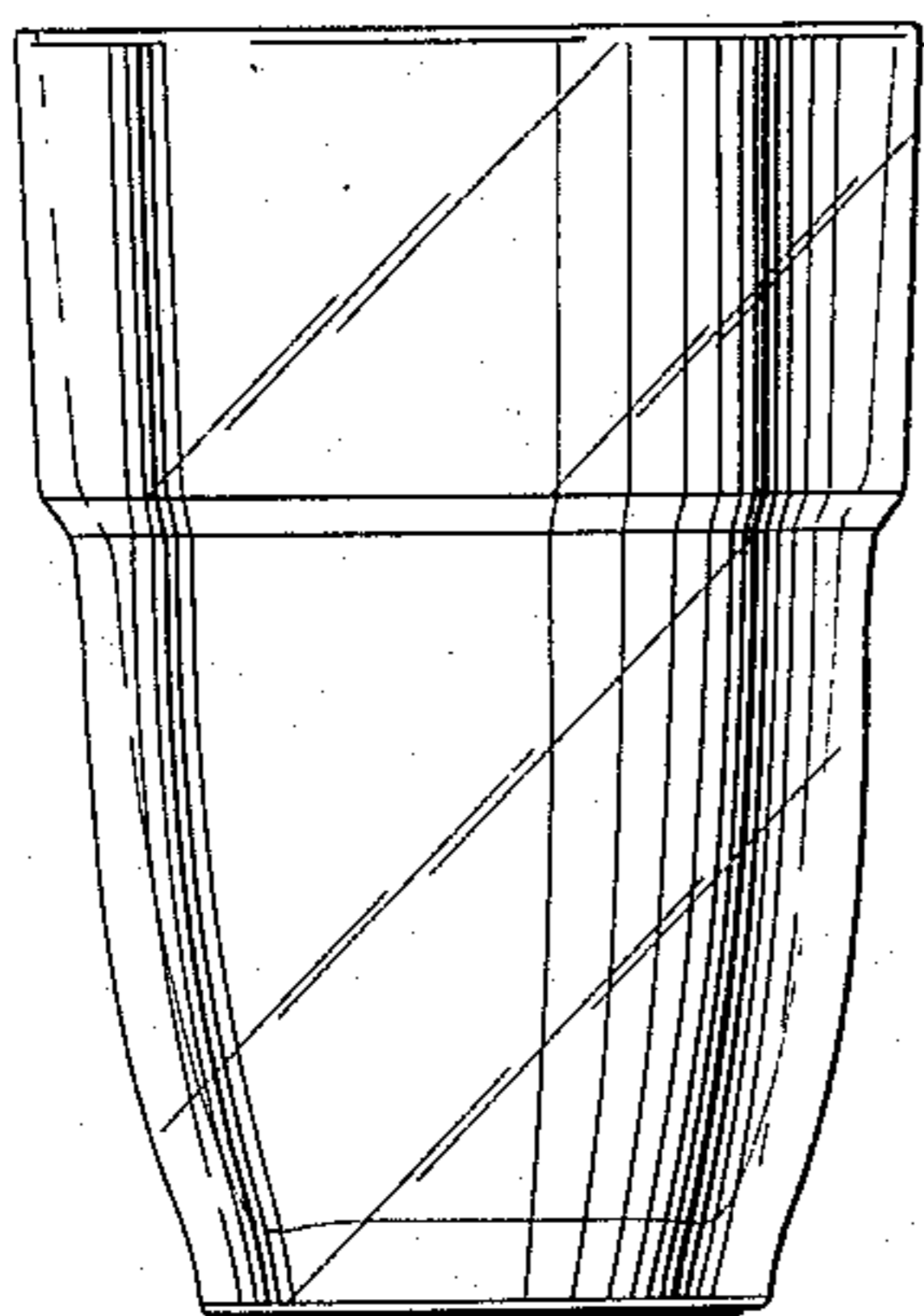
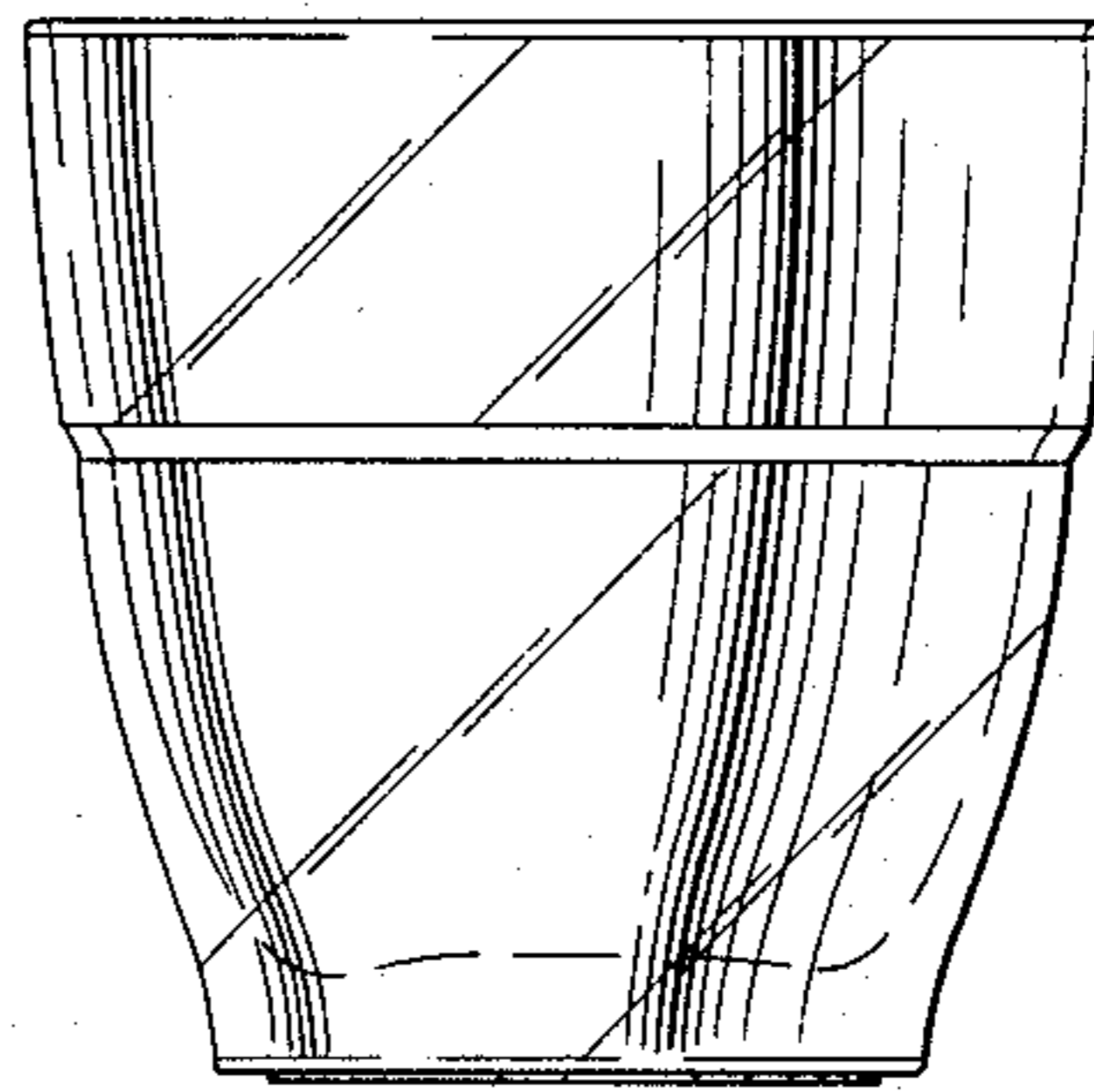
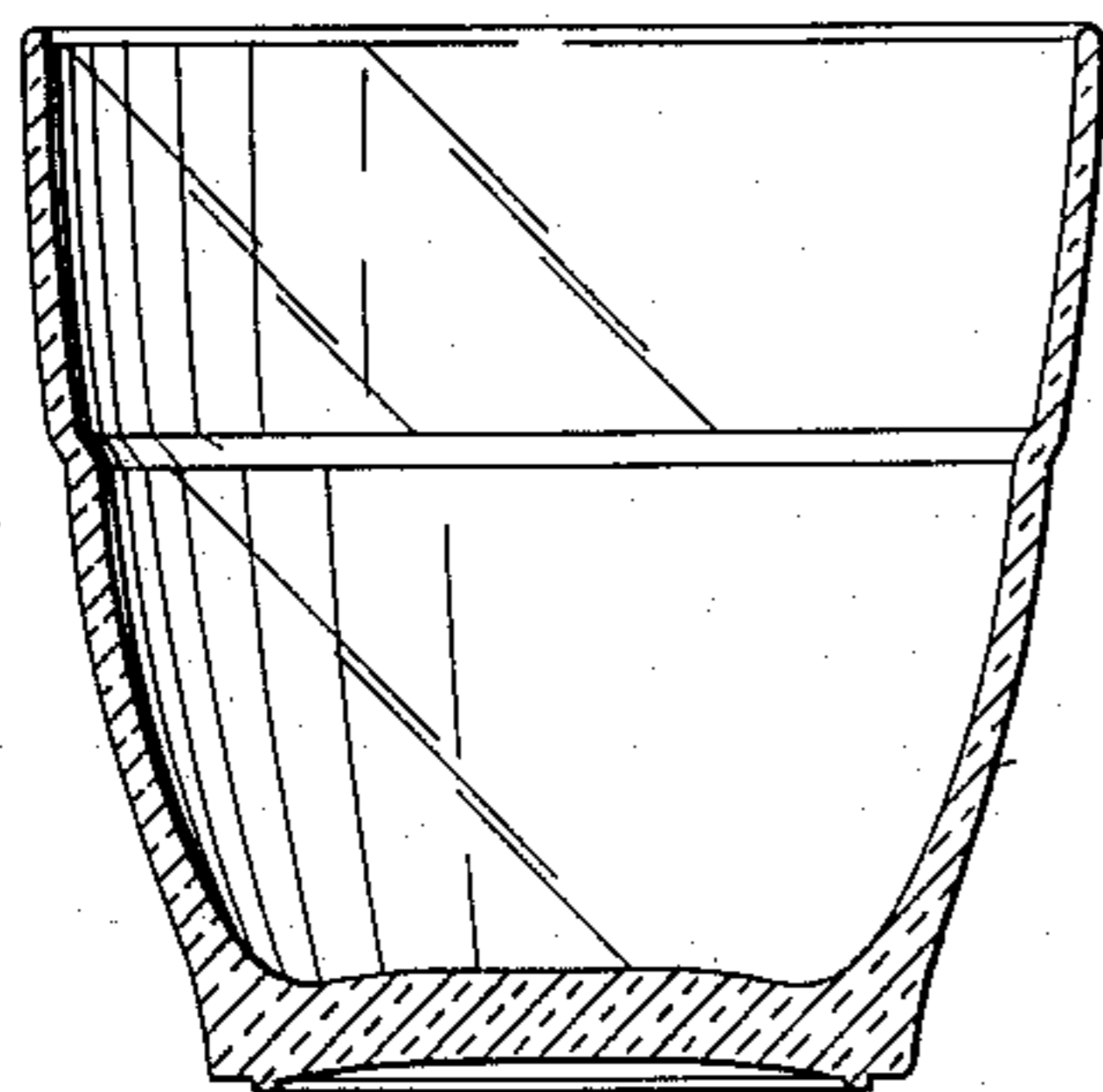

FIG. 1

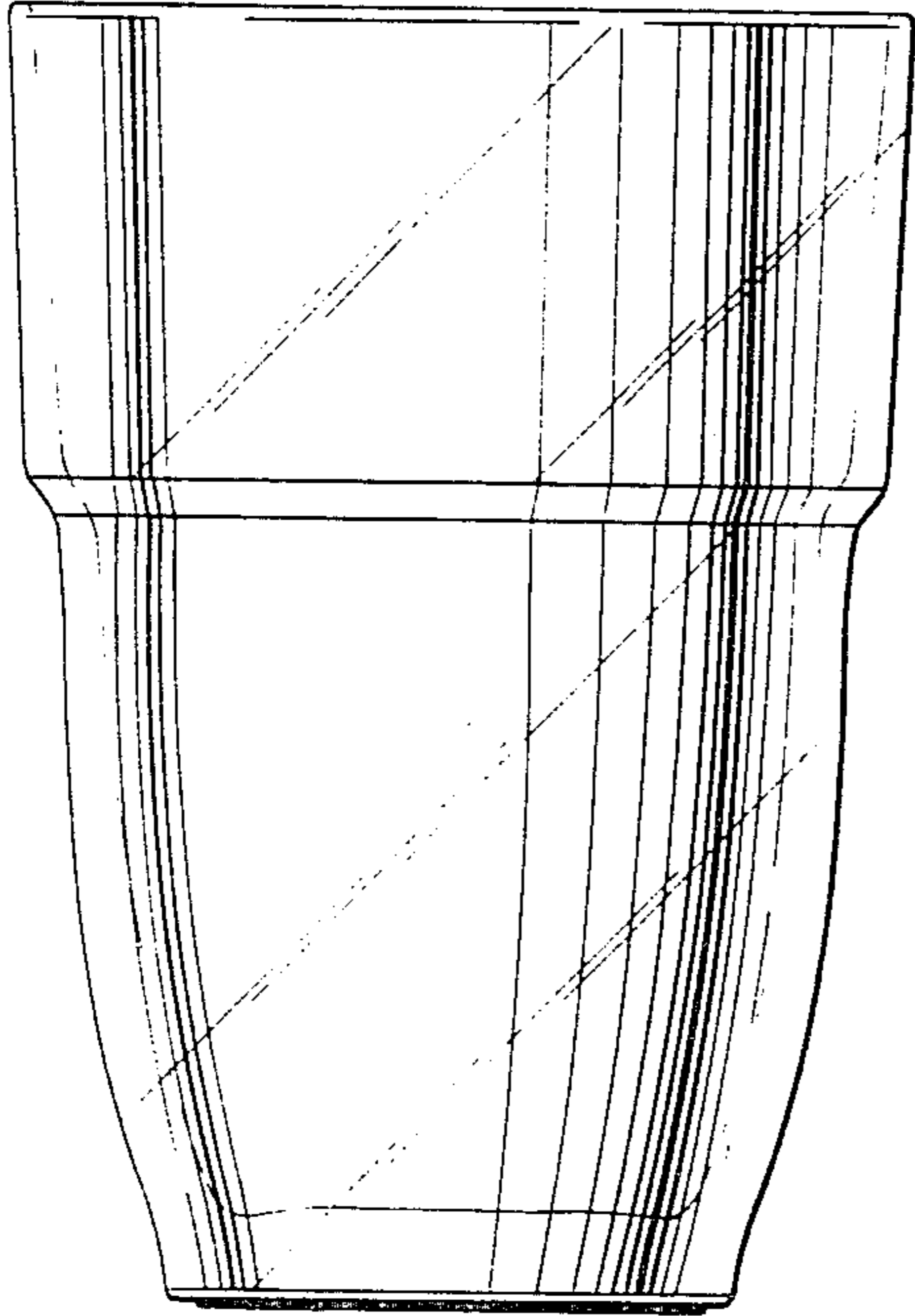

FIG. 2

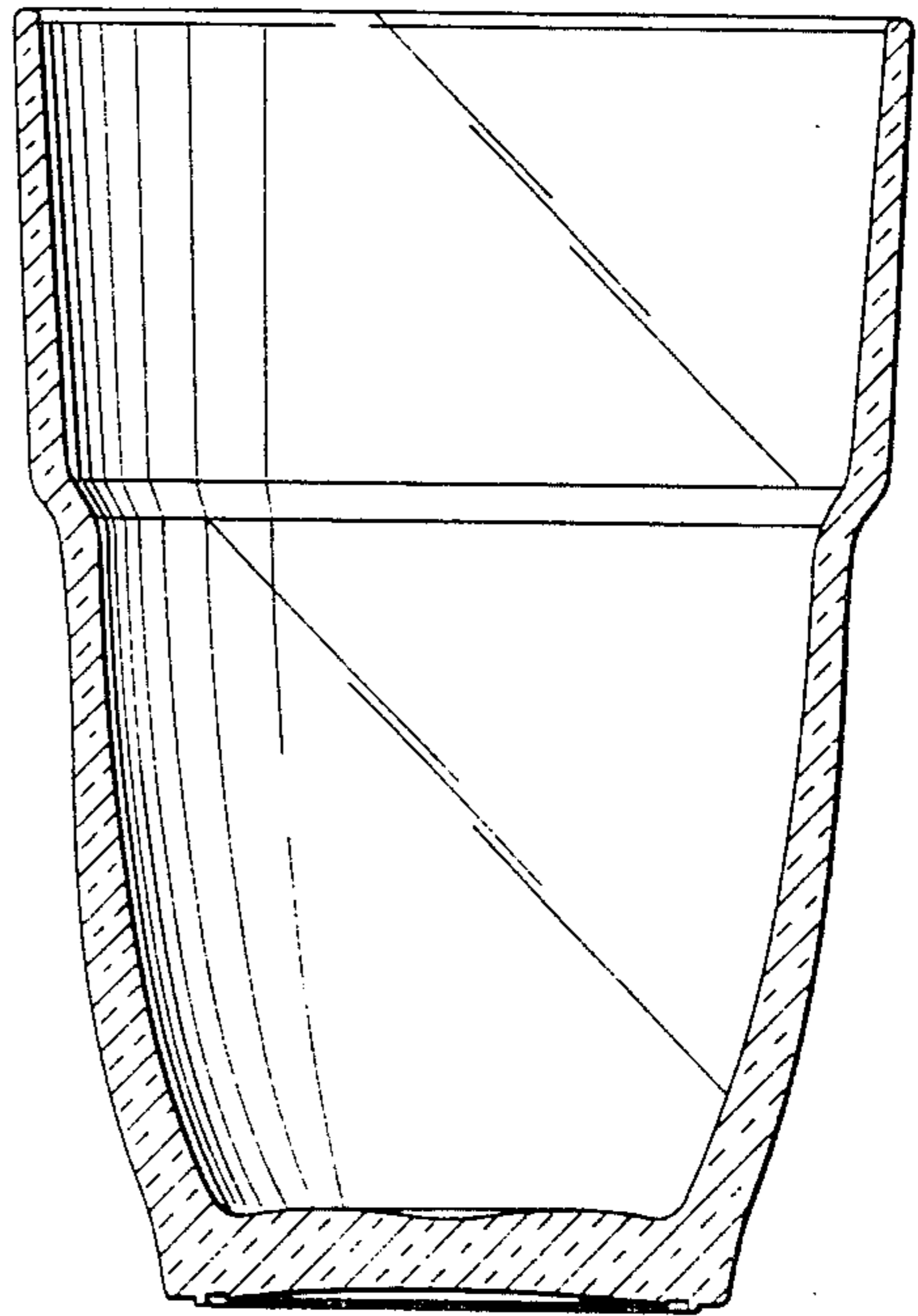

FIG. 3

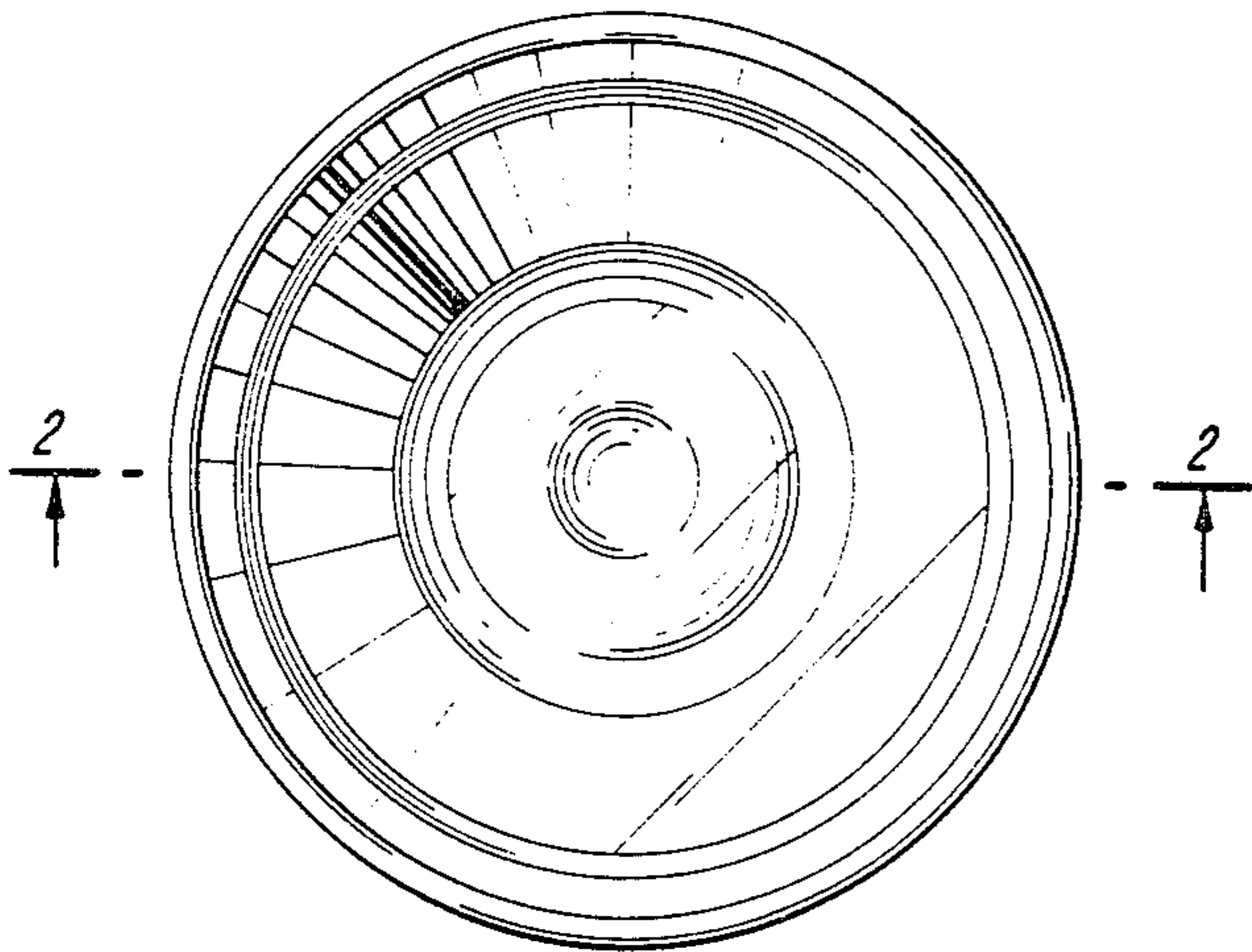

FIG. 4

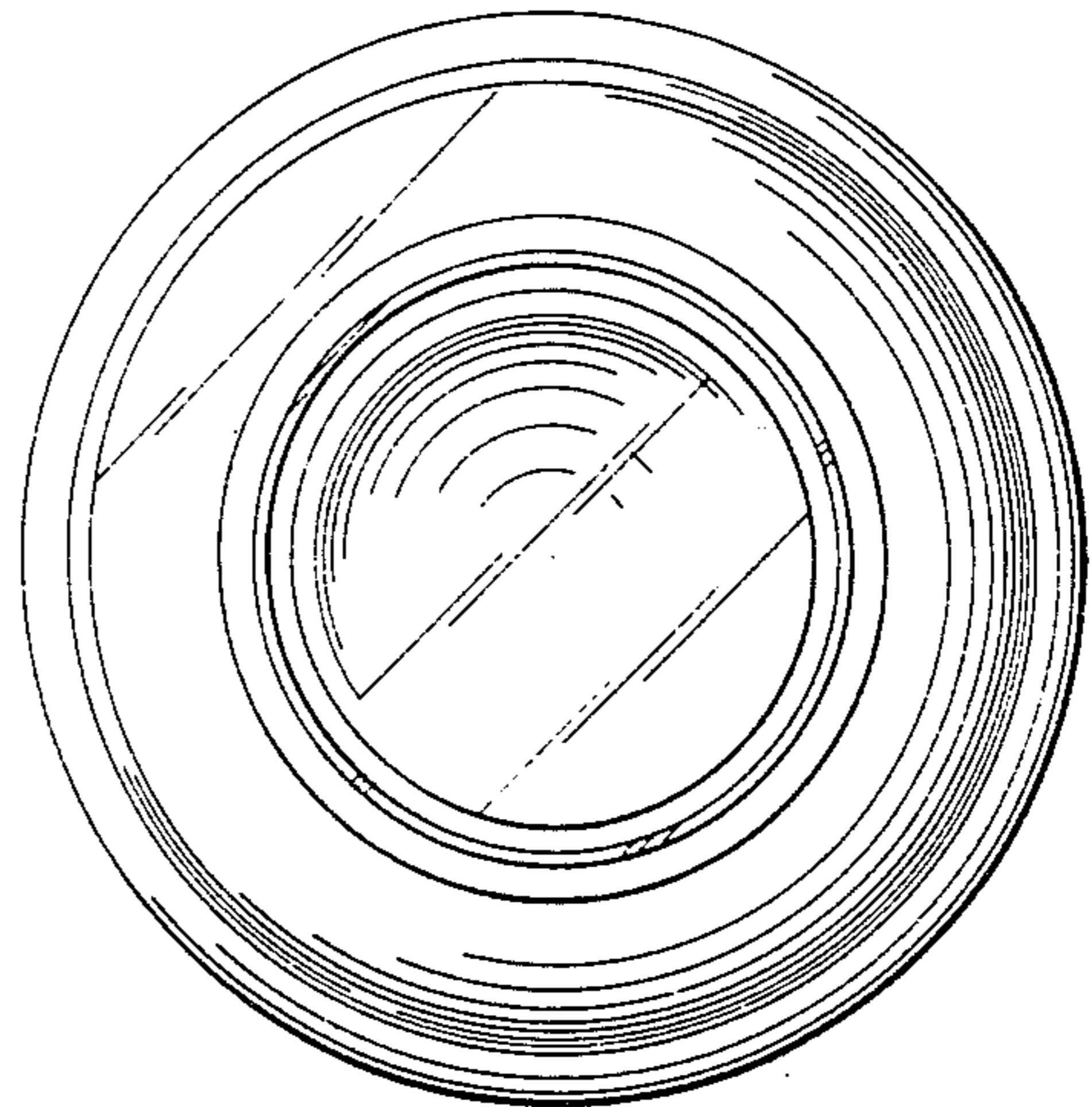

FIG. 5

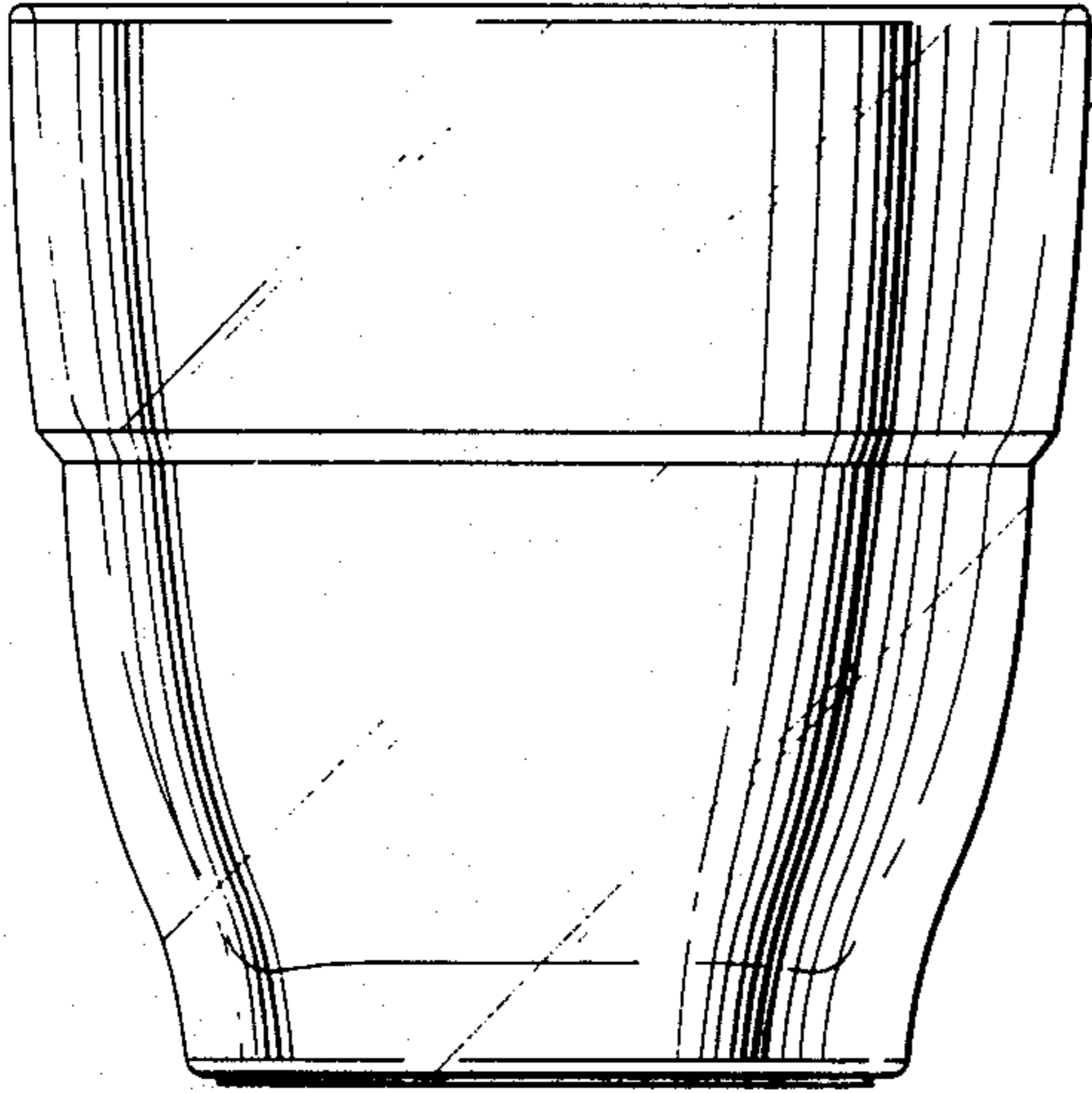

FIG. 6

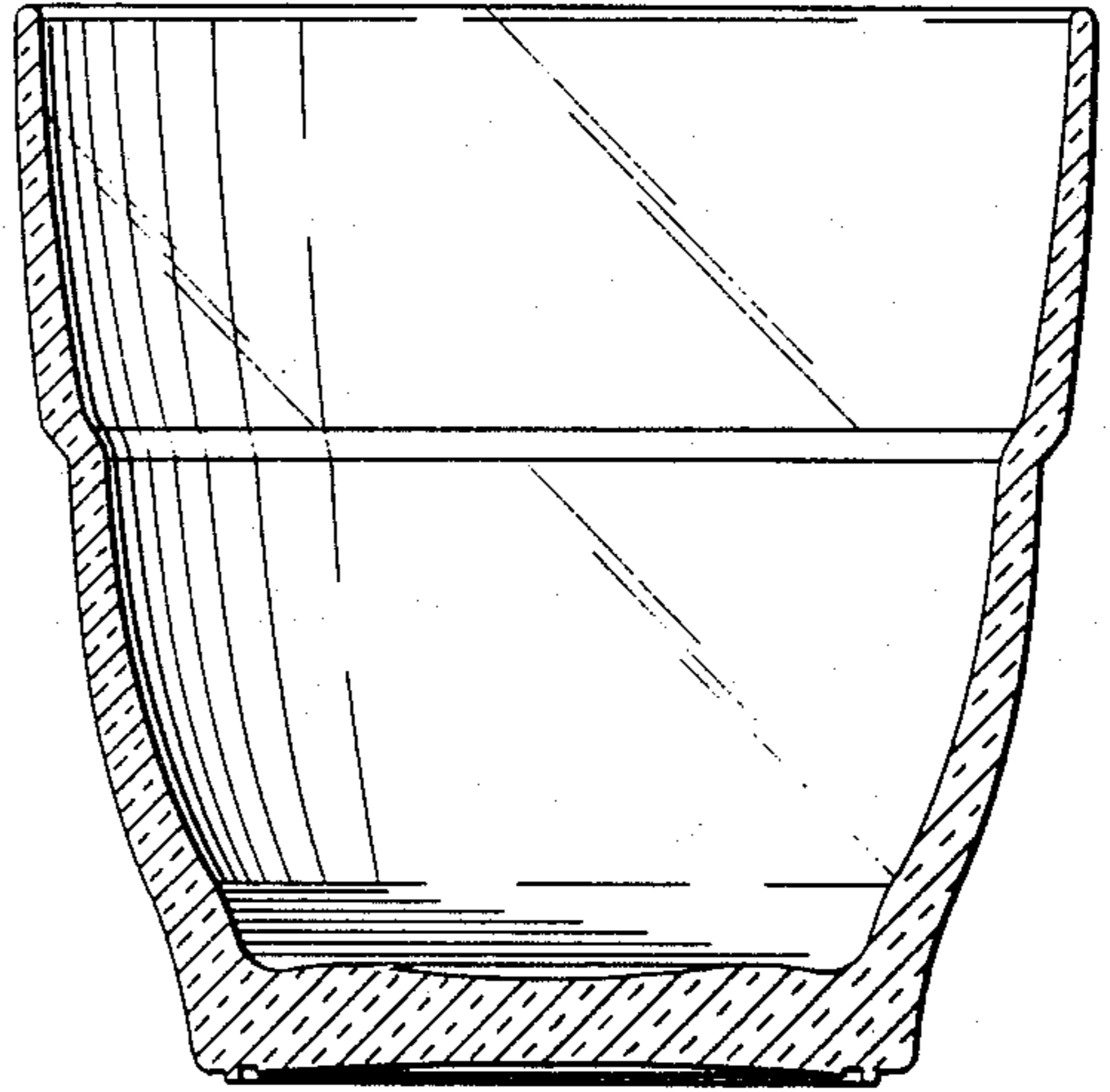

FIG. 7

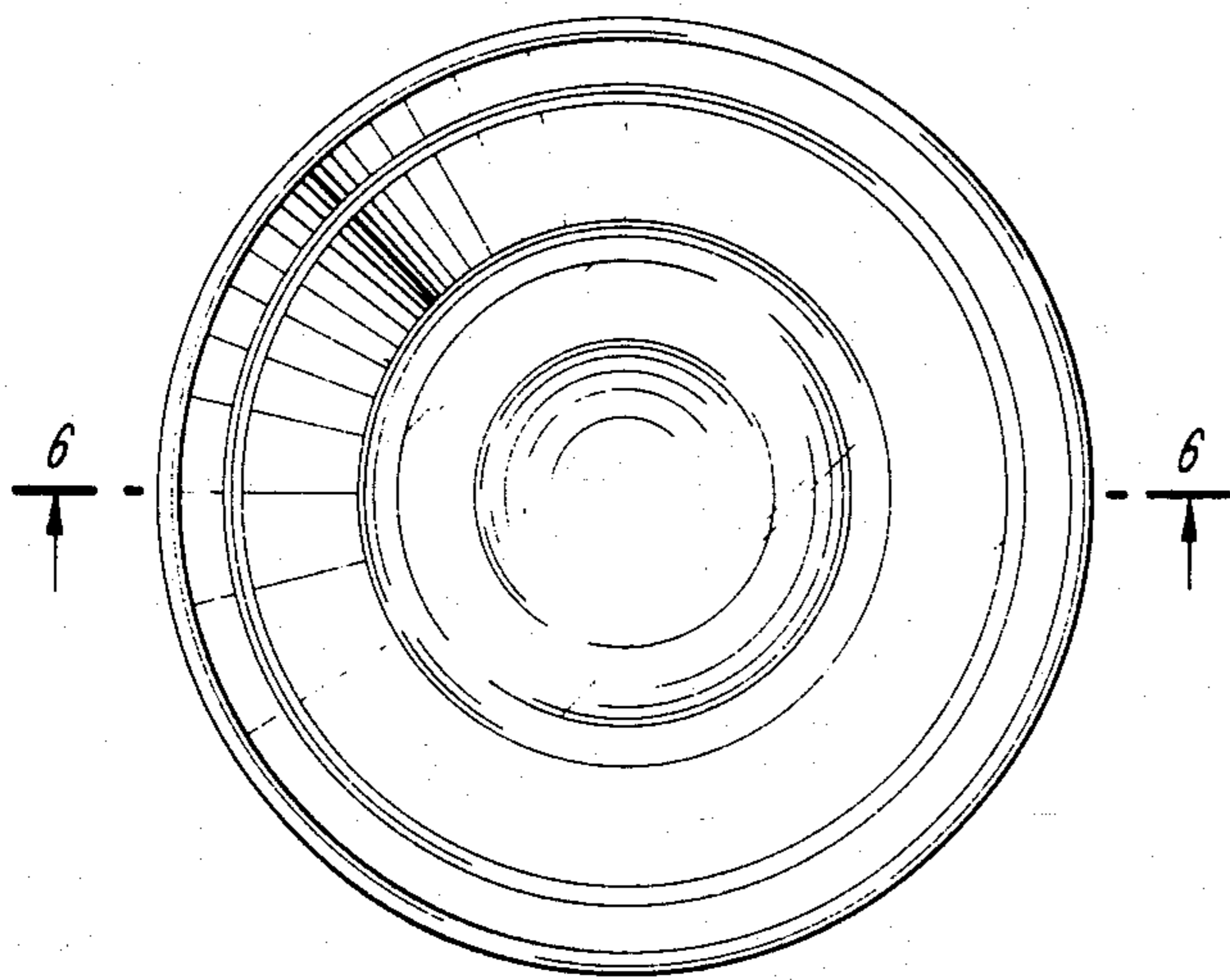

FIG. 8

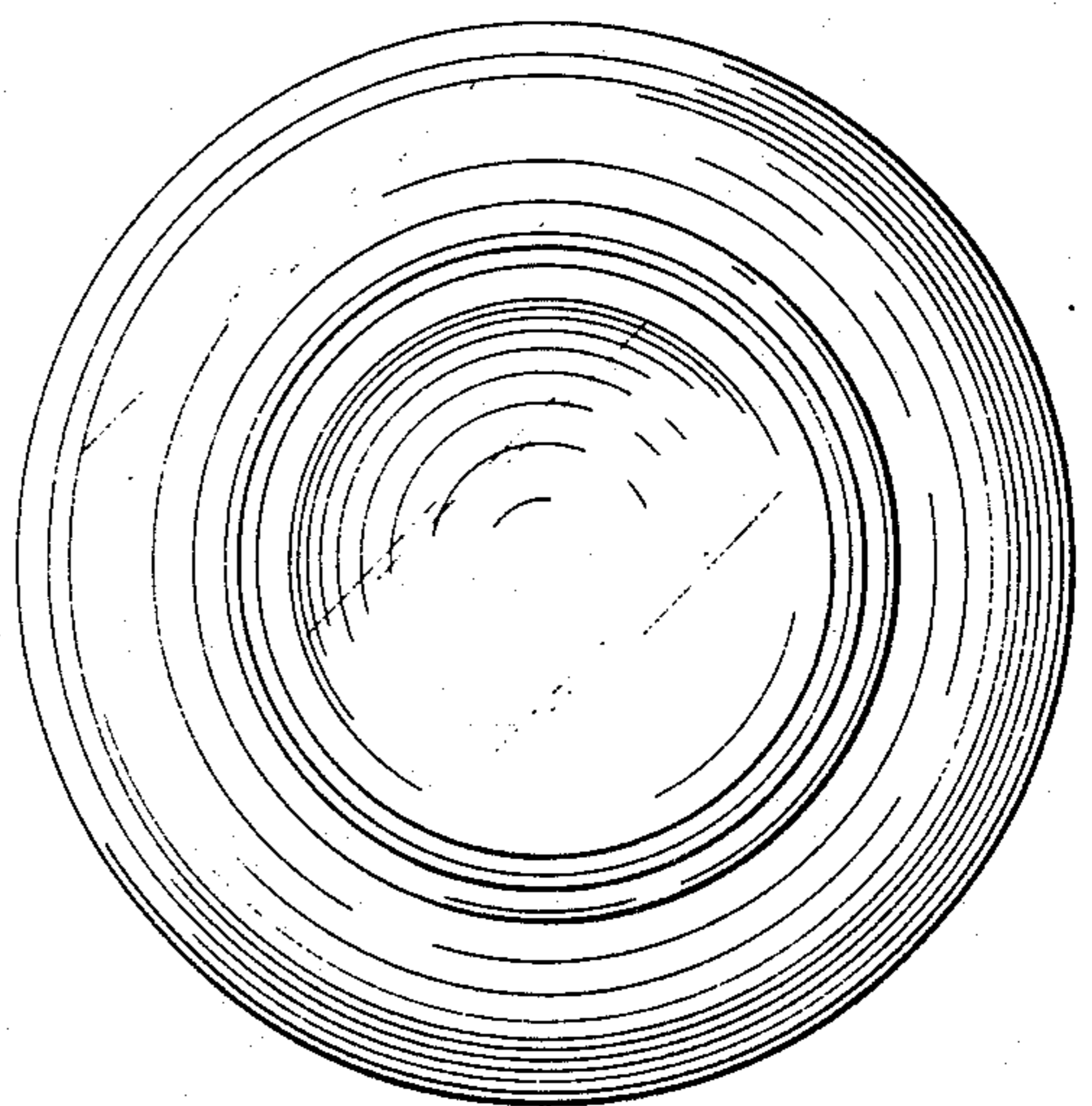

Fig. 9

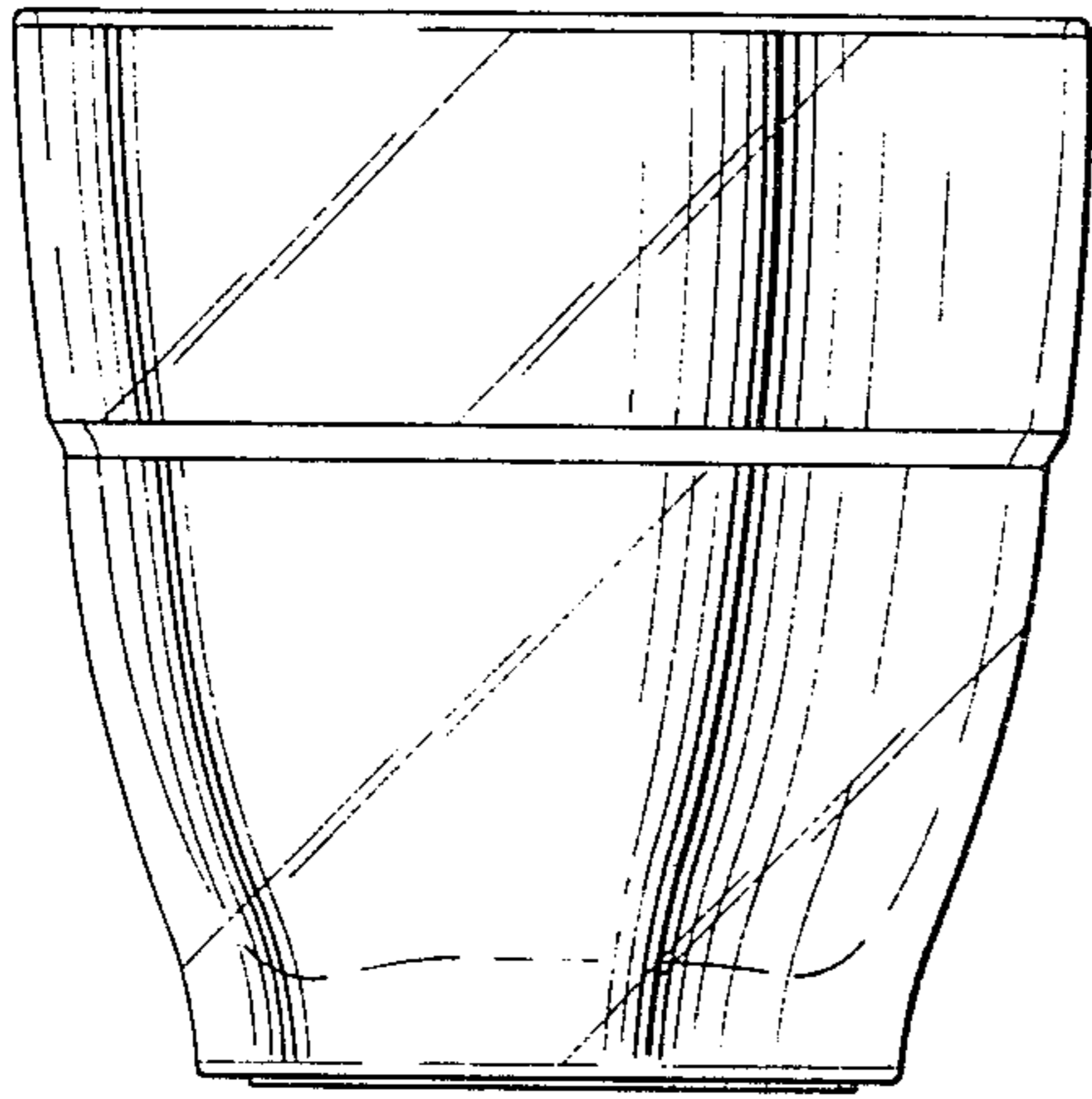

Fig. 10

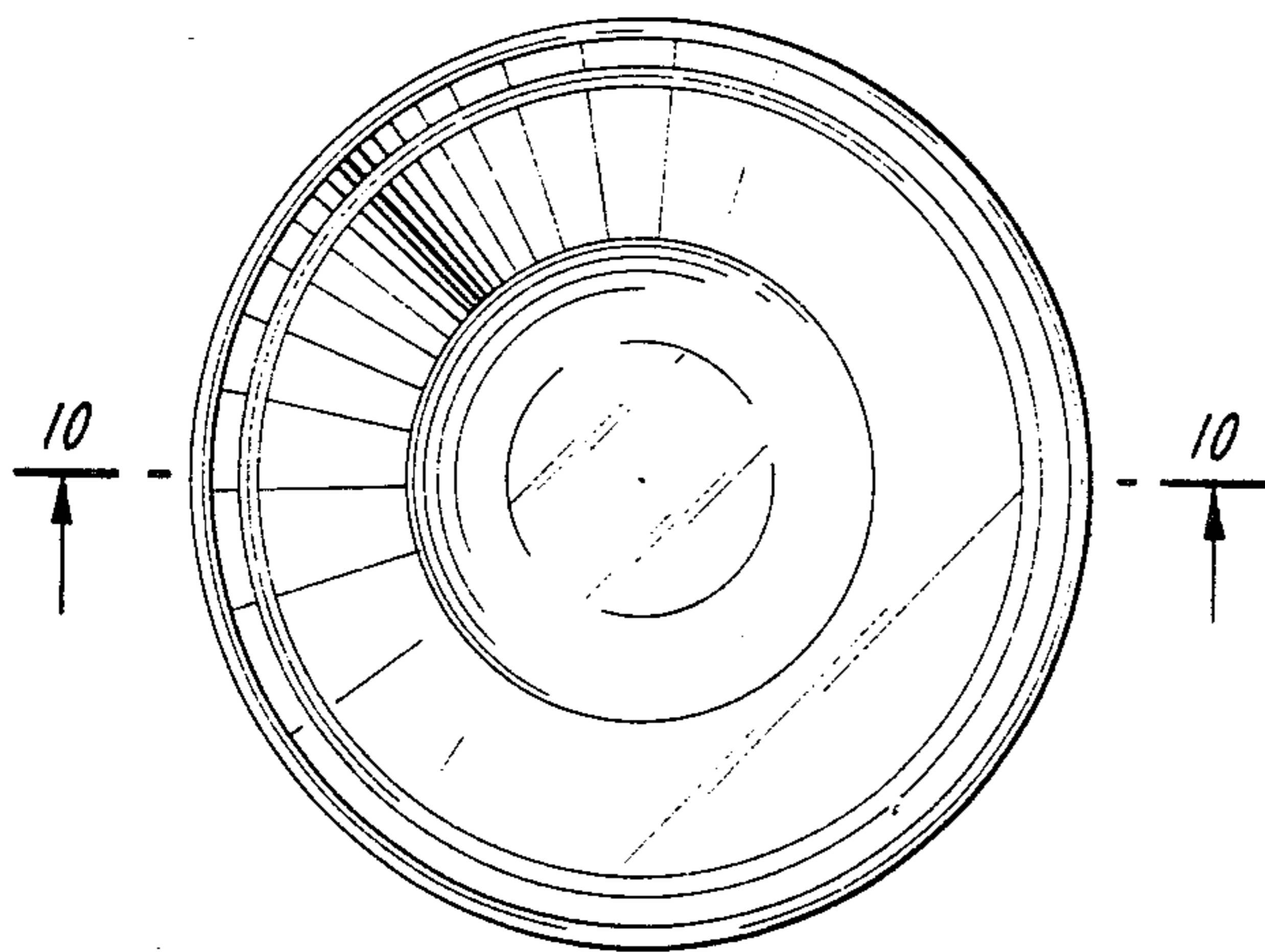
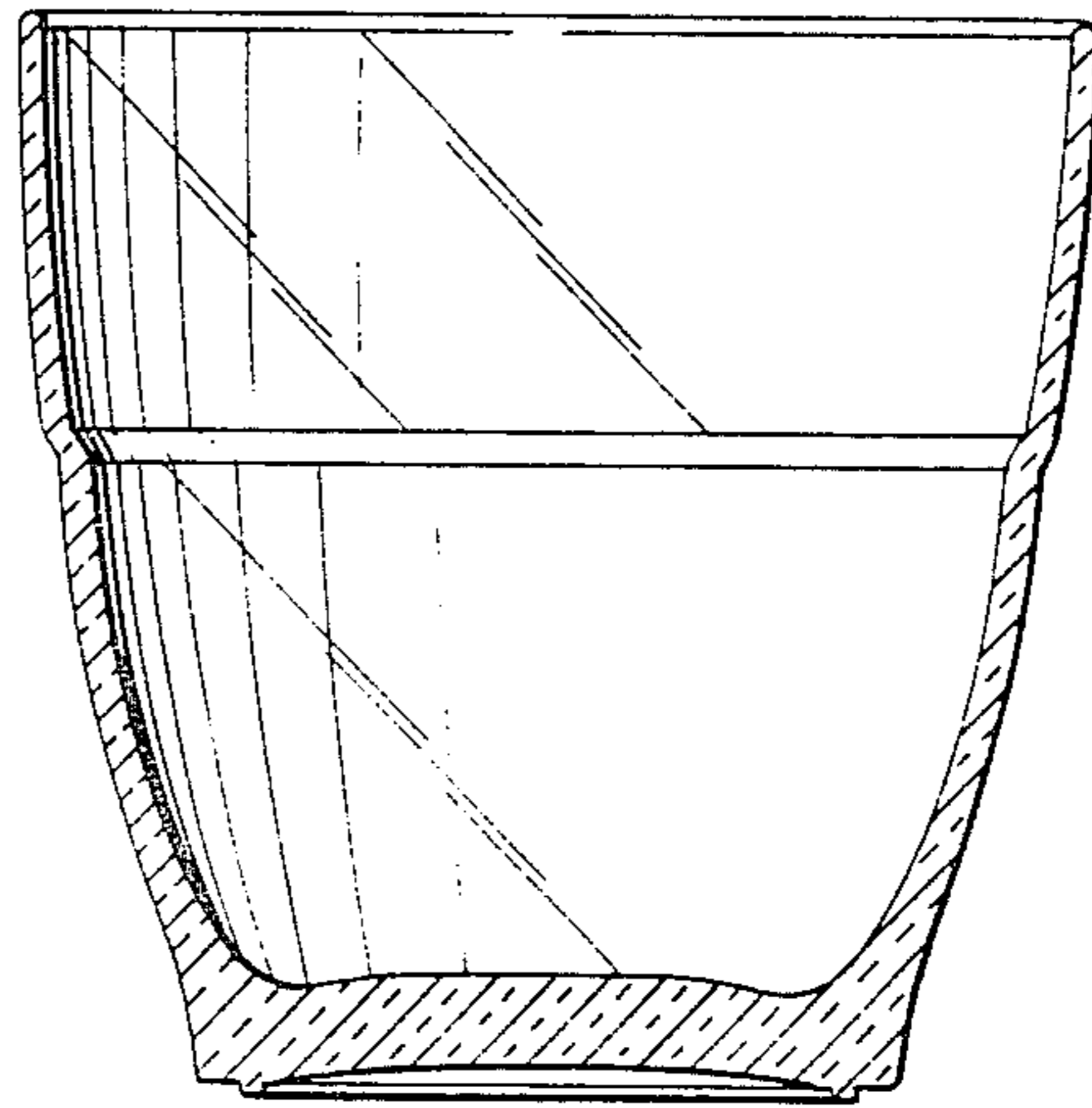

Fig. 11

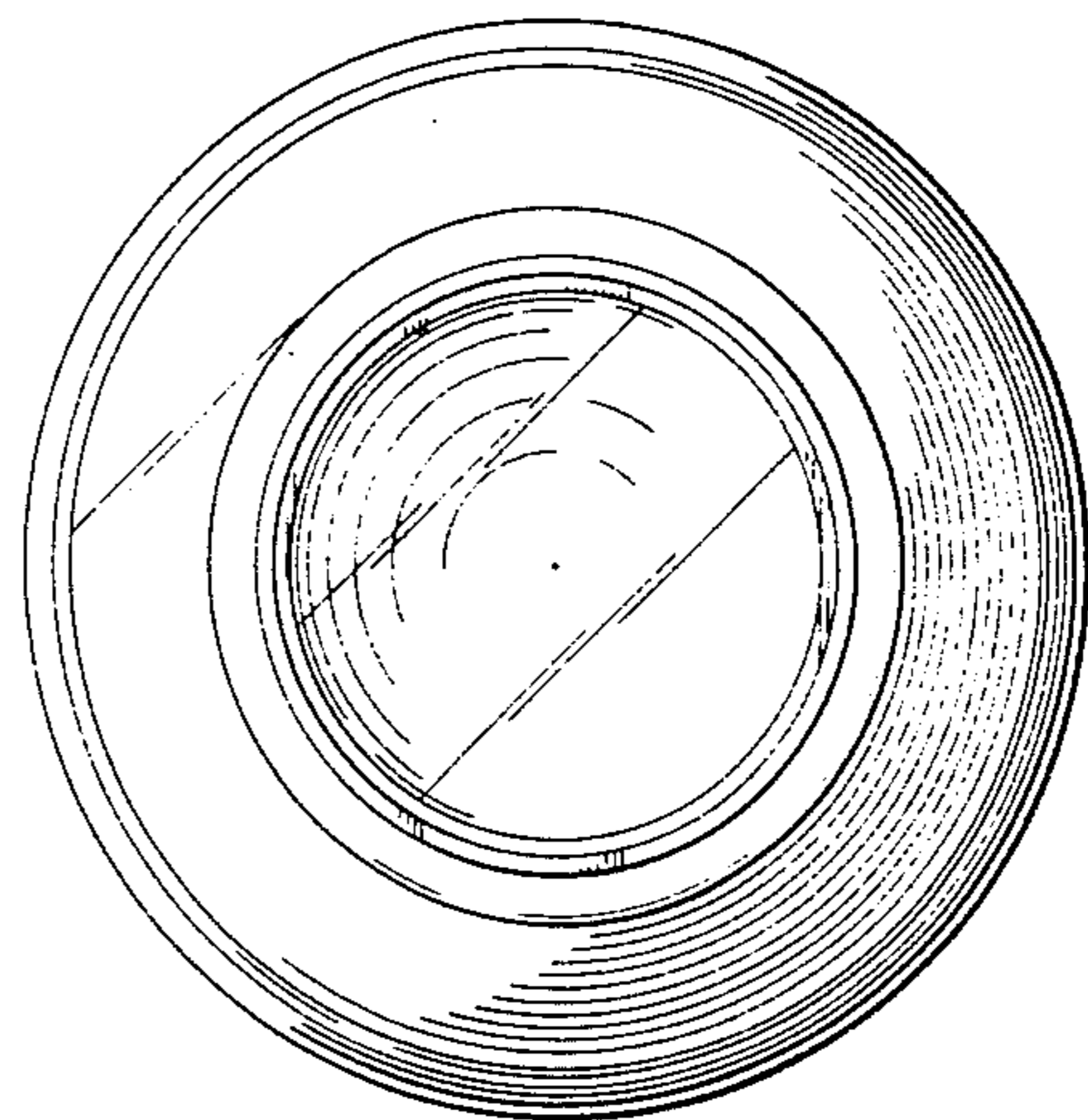

Fig. 12