

[54] LUGGAGE CASE FOR MOTORCYCLE

[75] Inventor: Karl H. Abe, Steinebach/Wörthsee, Fed. Rep. of Germany

[73] Assignee: Bayerische Motoren Werke Aktiengesellschaft, Fed. Rep. of Germany

[**] Term: 14 Years

[21] Appl. No.: 488,723

[22] Filed: Apr. 26, 1983

[30] Foreign Application Priority Data

Oct. 26, 1982 [DE] Fed. Rep. of Germany 13 131

[52] U.S. Cl. D12/158

[58] Field of Search D12/158; 224/32 R, 32 A

[56] References Cited

U.S. PATENT DOCUMENTS

D. 275,190 8/1984 Gevert D12/158

OTHER PUBLICATIONS

Cycle World, 5/81, p. 106, Luggage Case, top left side of page.

Primary Examiner—James M. Gandy
Attorney, Agent, or Firm—Craig & Burns

[57] CLAIM

The ornamental design for a luggage case for motorcycle, as shown and described.

DESCRIPTION

FIG. 1 is a perspective view from the top, the front and left side of the luggage case for motorcycle of my new design;

FIG. 2 is a side perspective view thereof from the side shown in FIG. 1;

FIG. 3 is a side perspective view thereof from the side opposite that shown in FIG. 2;

FIG. 4 is a perspective view from the top, the rear and right side thereof;

FIG. 5 is a bottom perspective view thereof;

FIG. 6 is a top perspective view thereof;

FIG. 7 is a rear perspective view thereof; and

FIG. 8 is a front perspective view thereof.

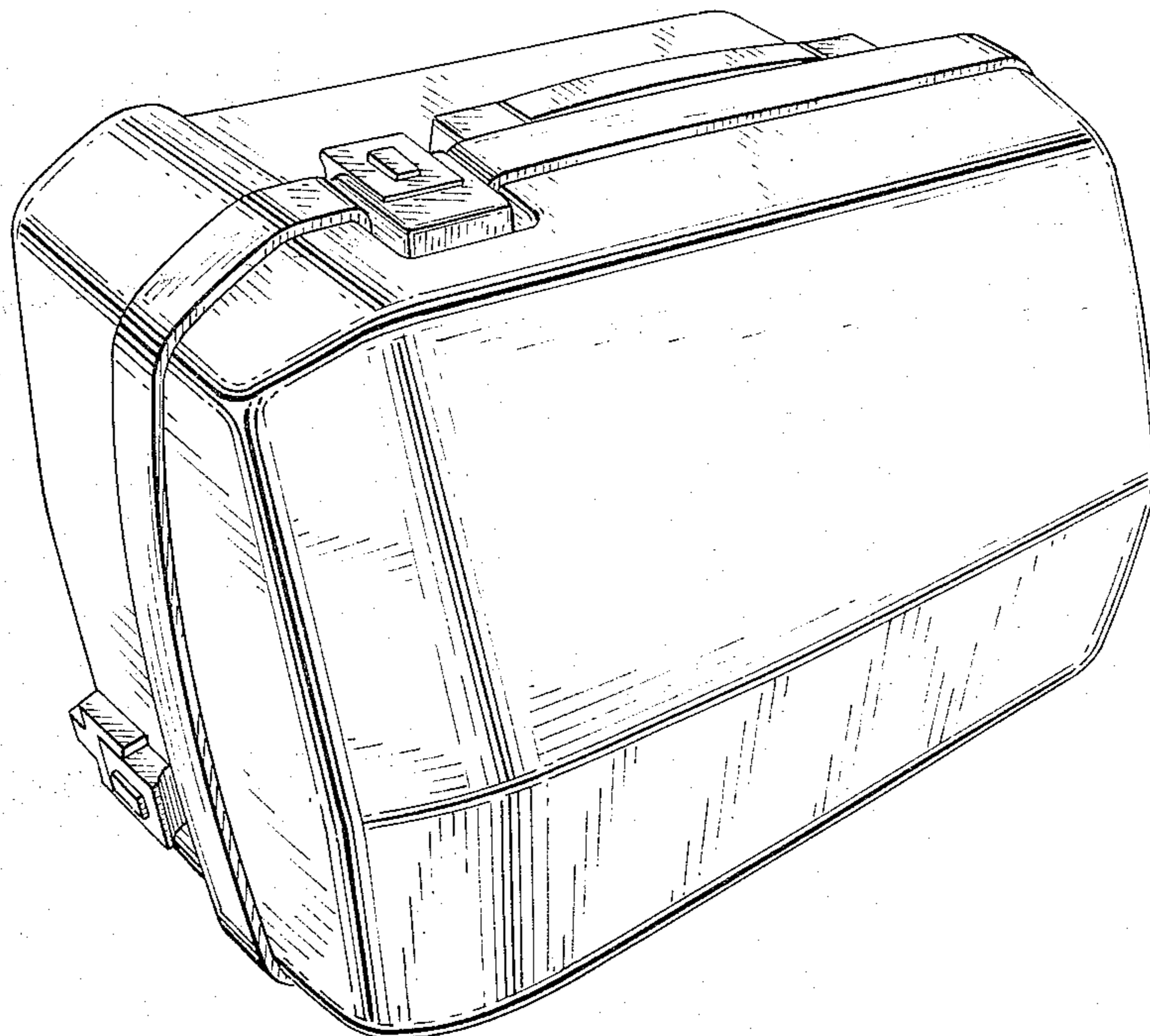

FIG. 1

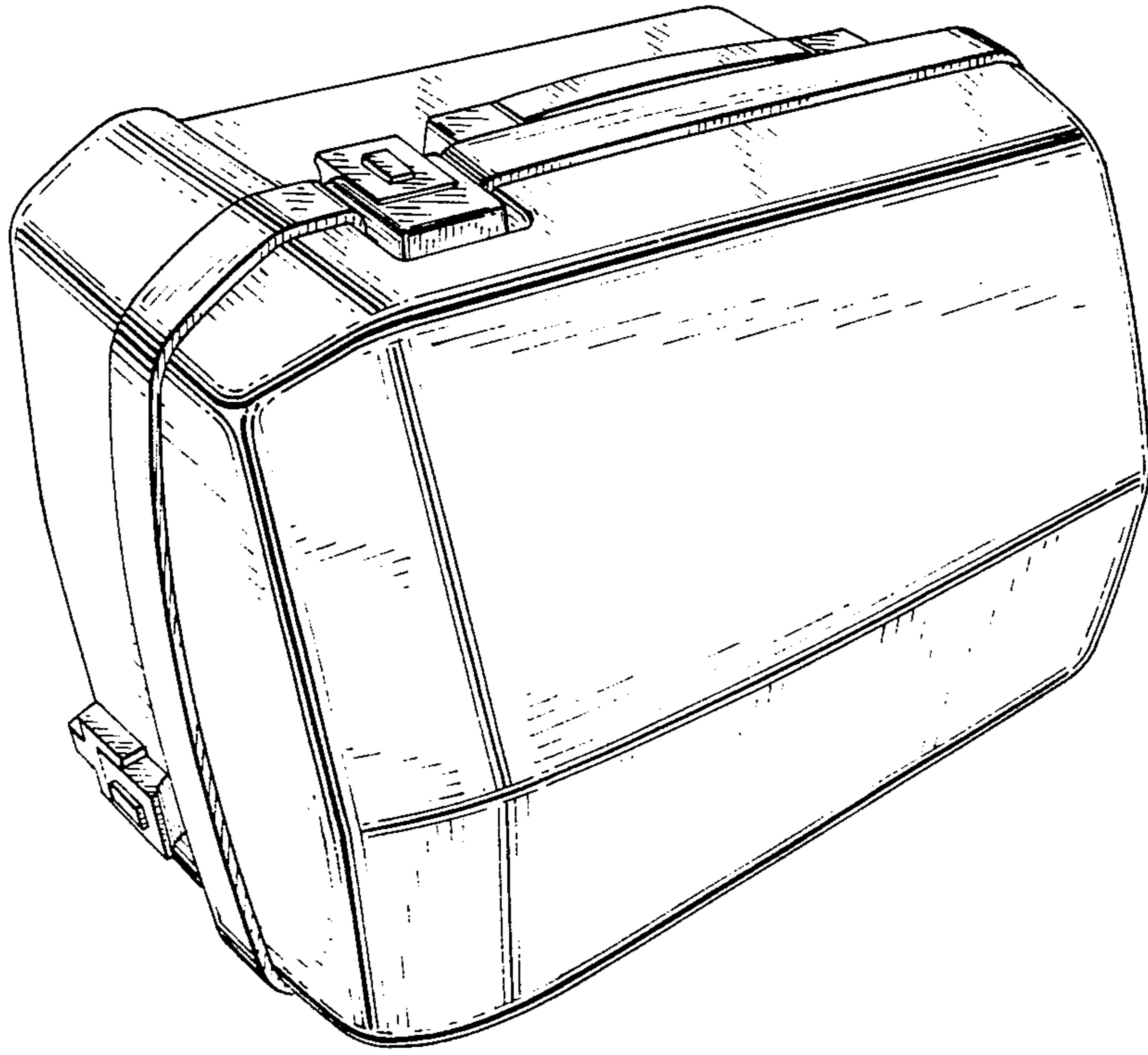

FIG. 2

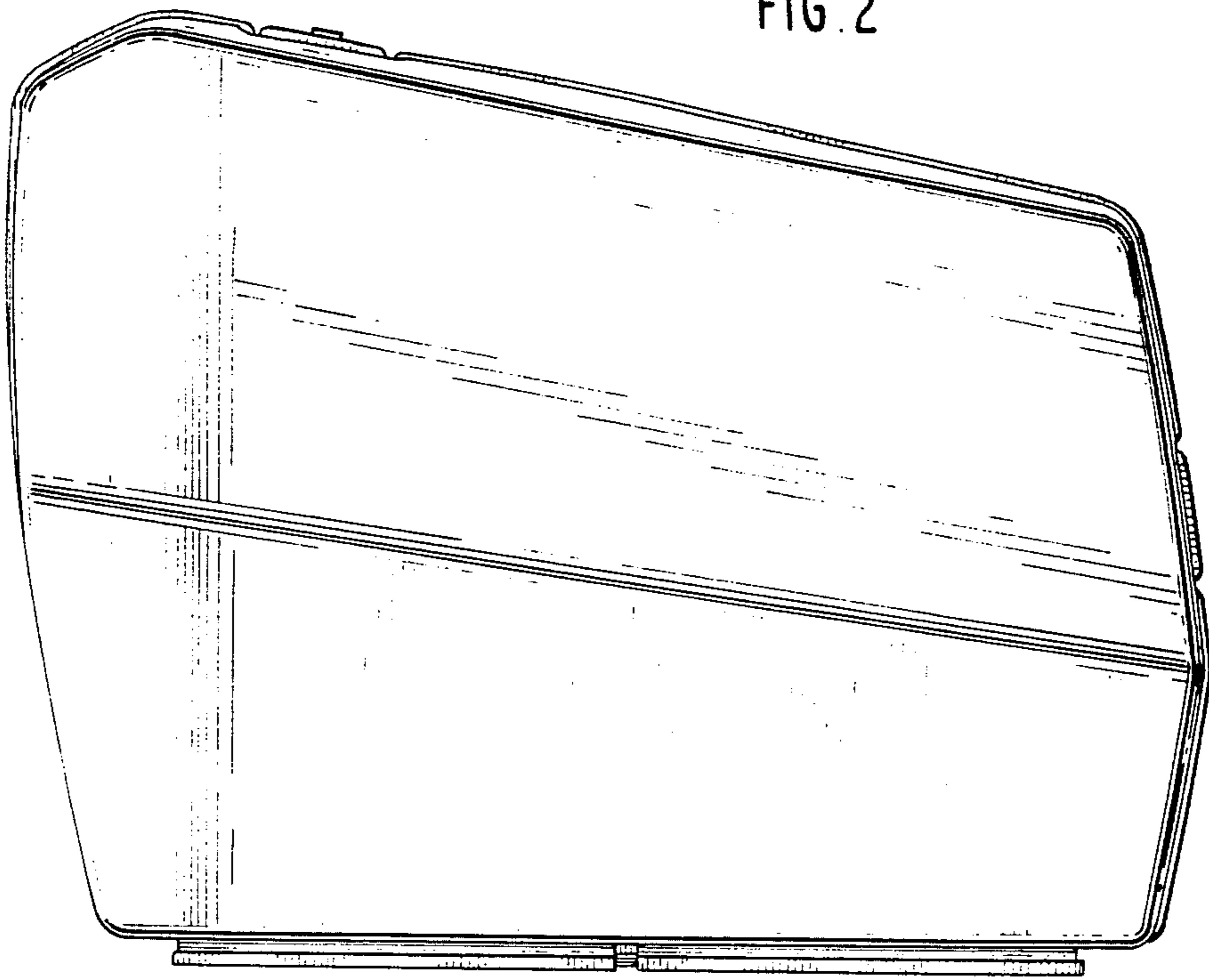

FIG. 3

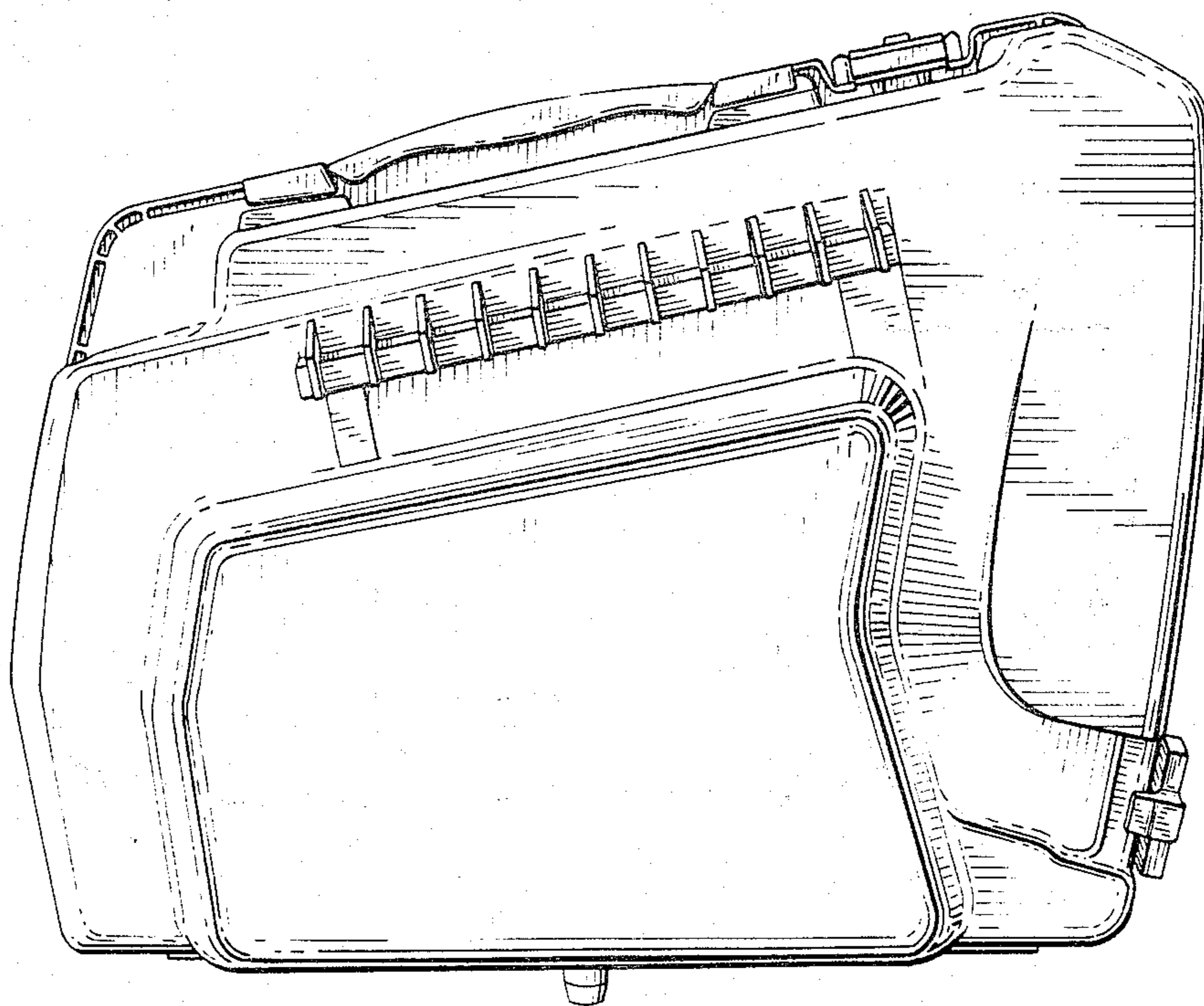
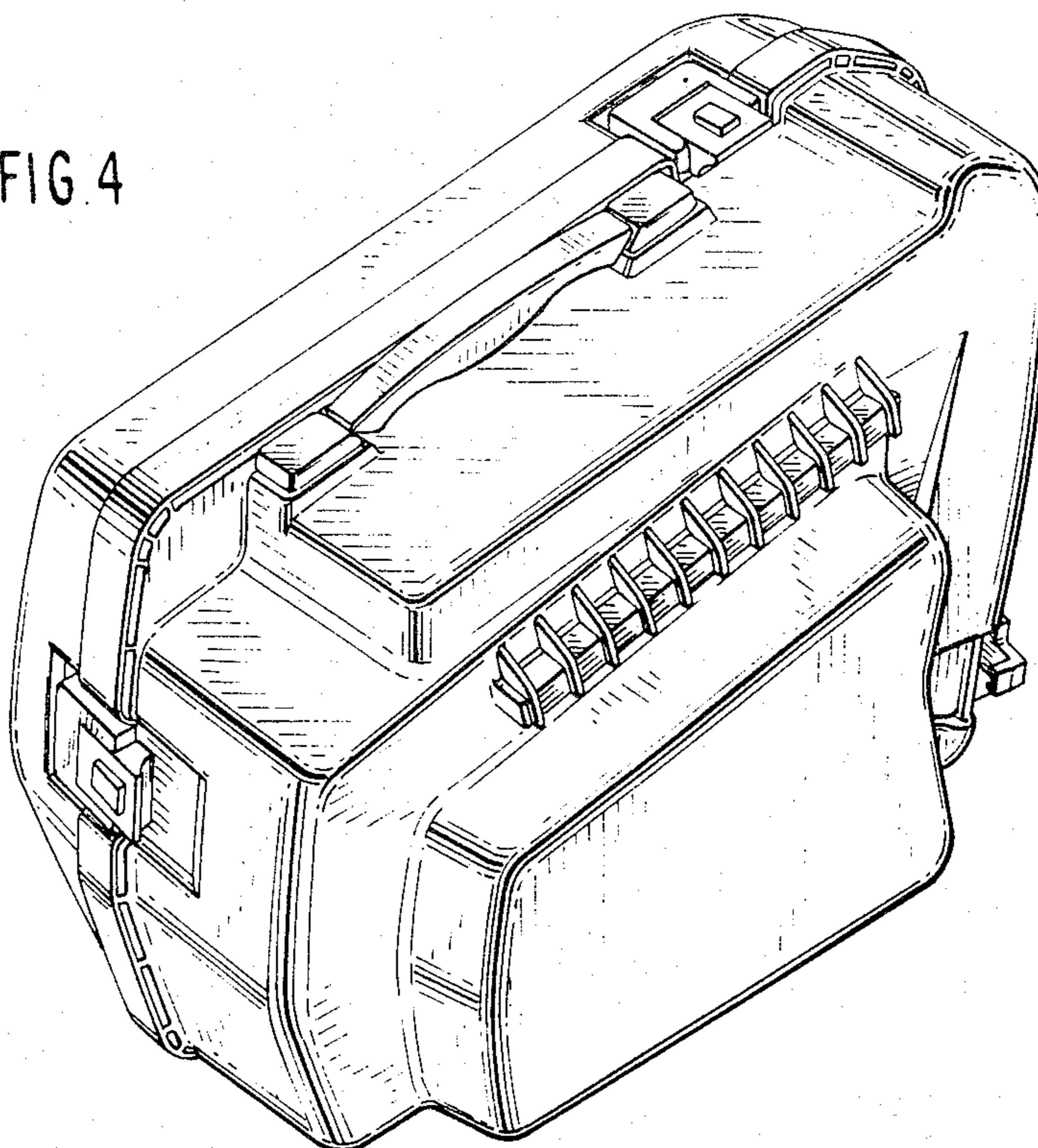

FIG. 4



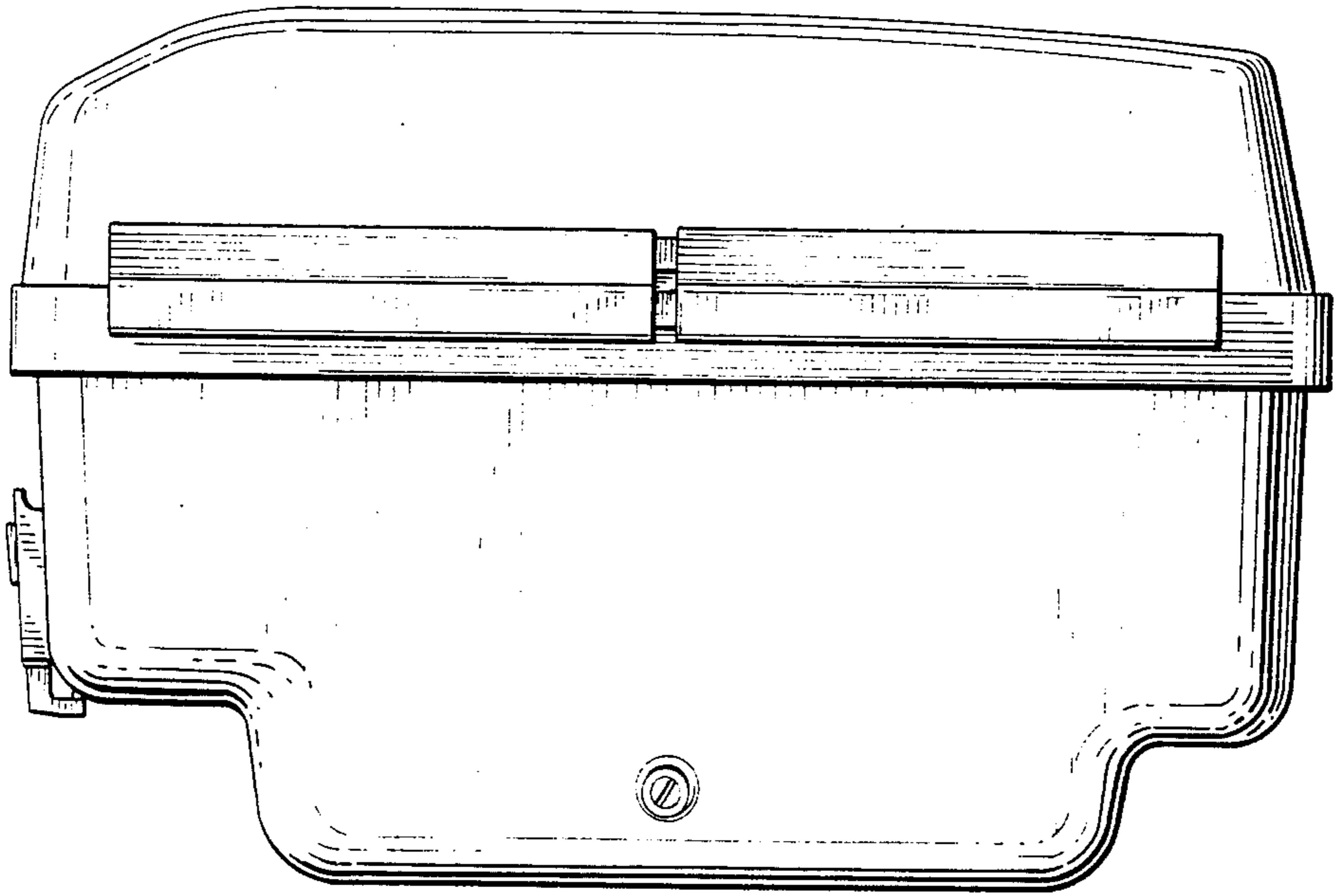

FIG. 5

FIG. 6

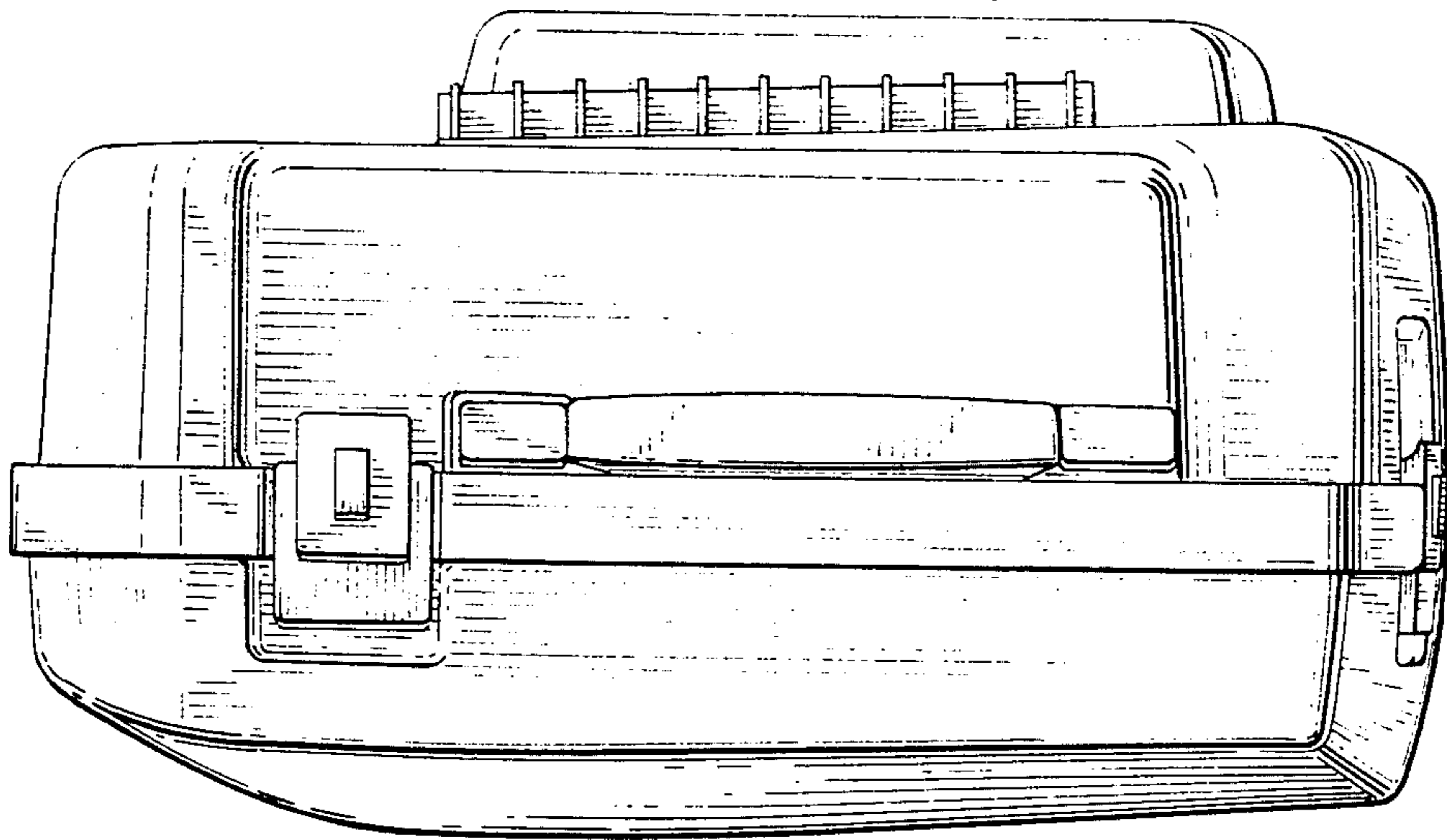

FIG. 7

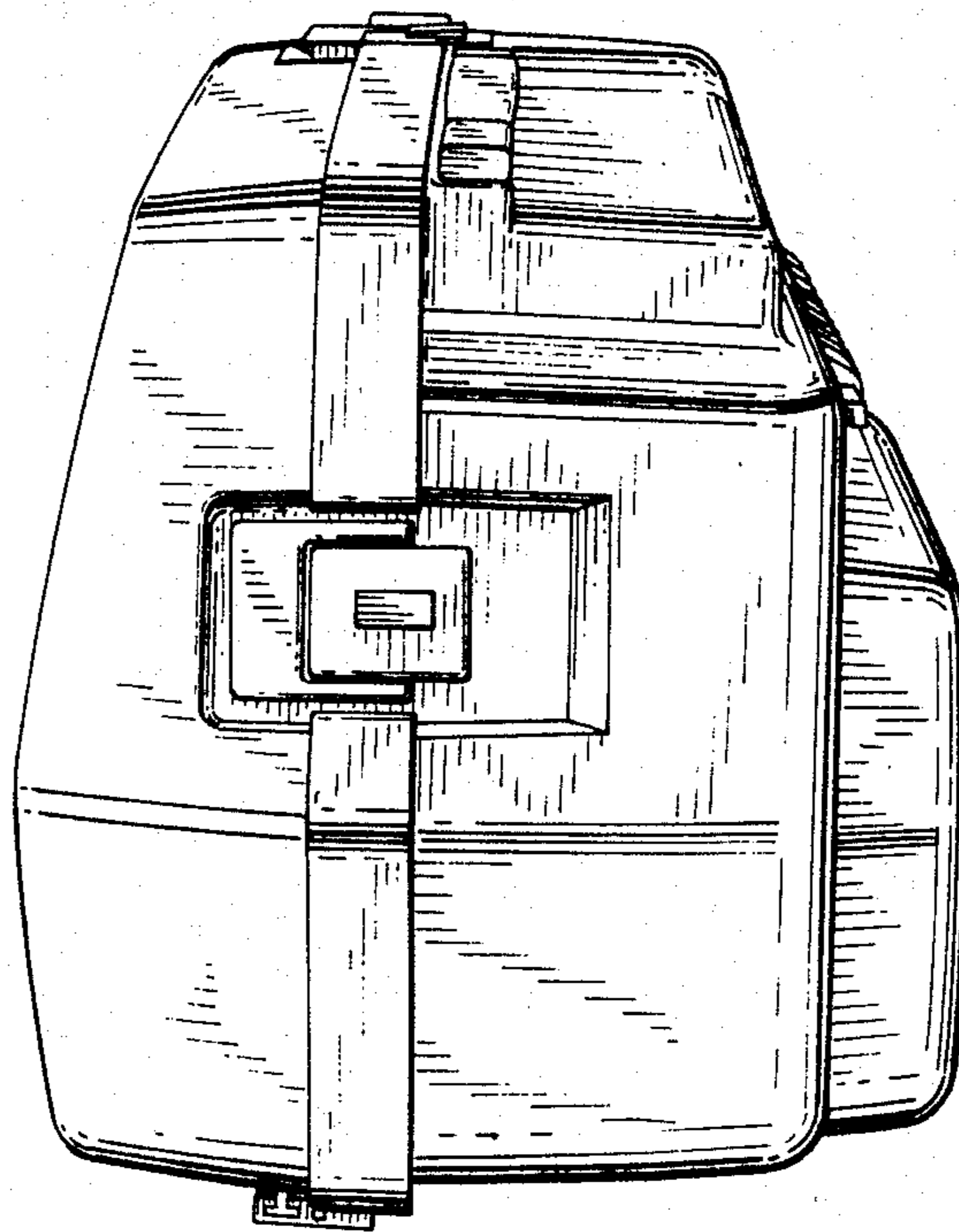

FIG. 8

